

et al.

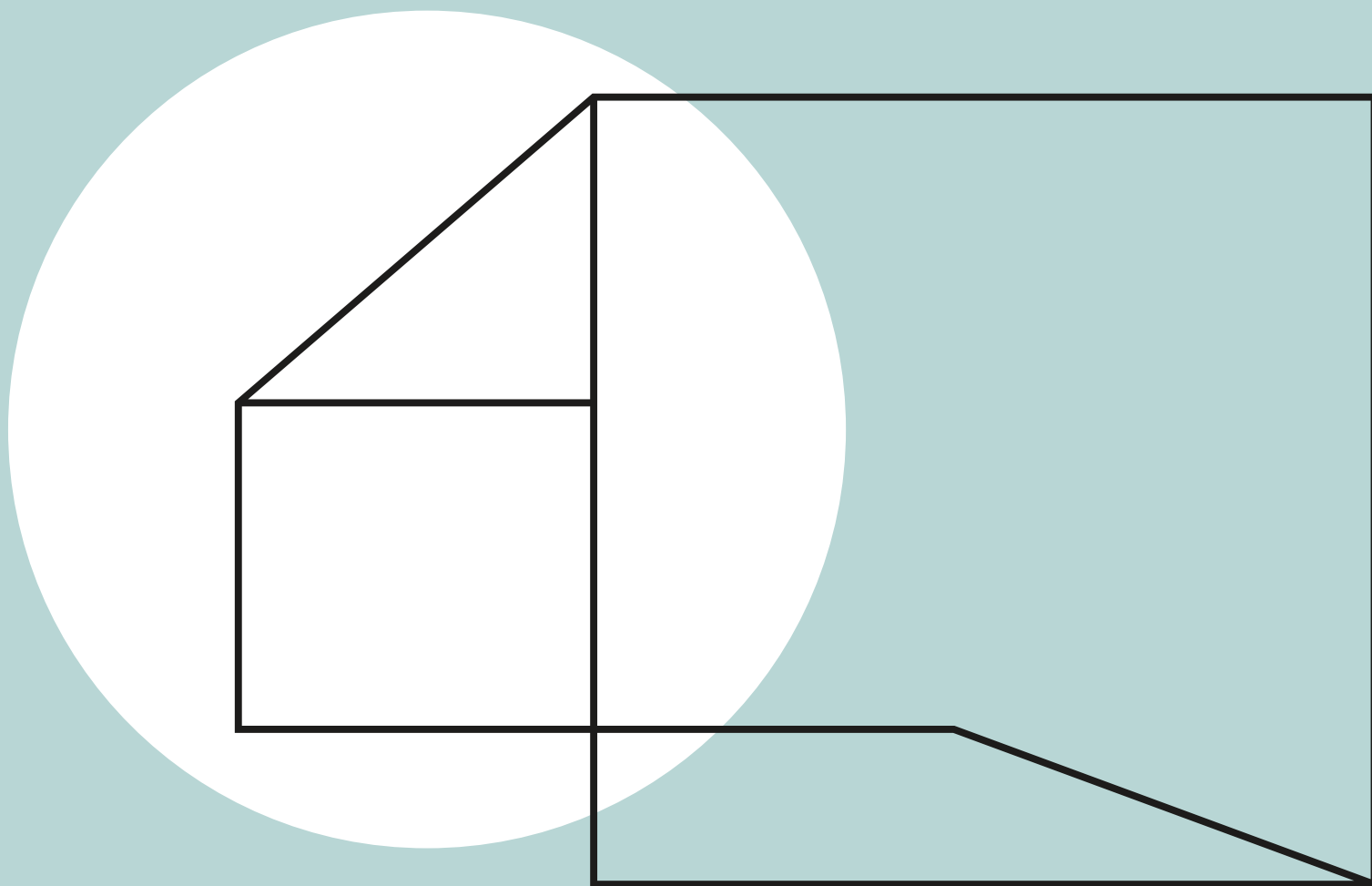

et al.

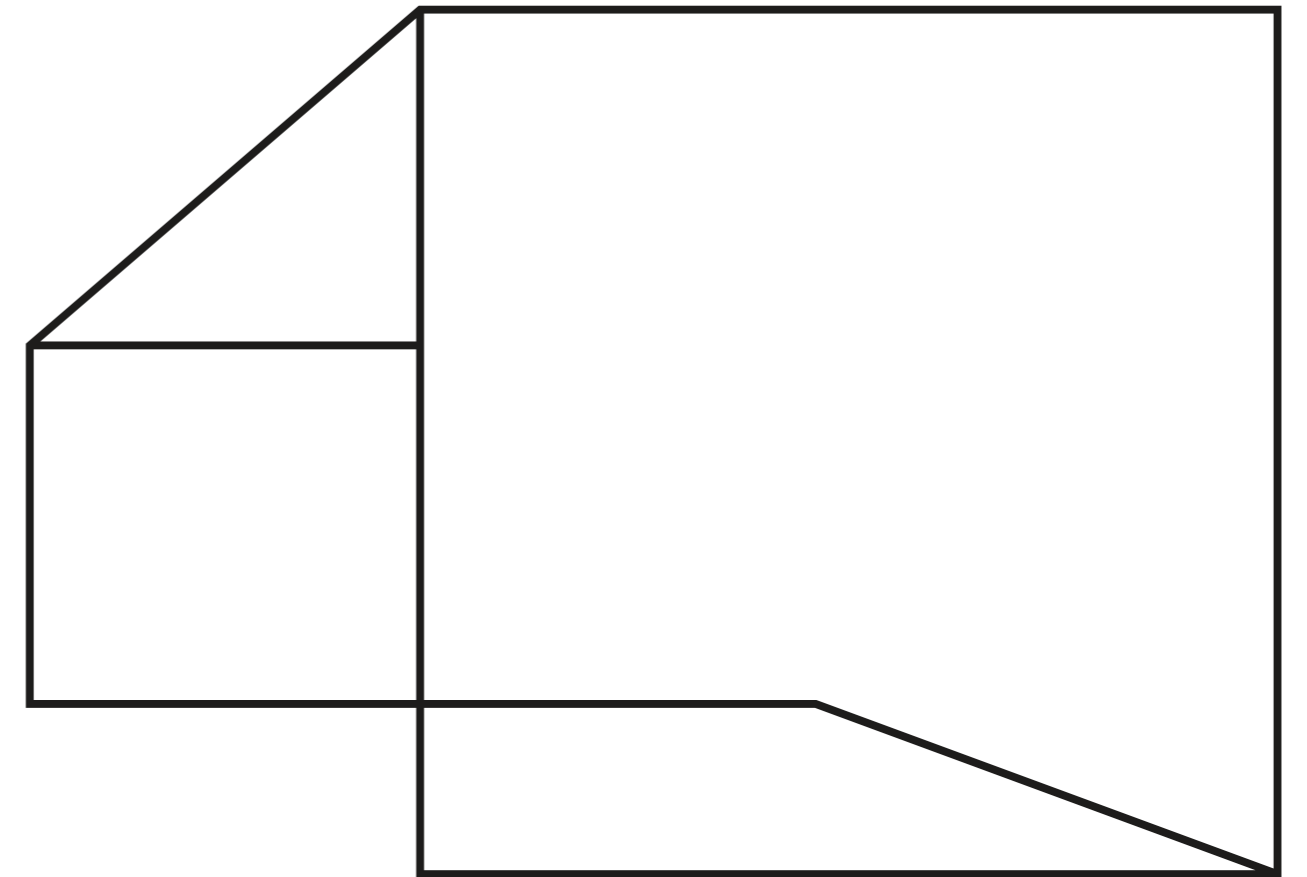

Metalmobil diventa **Et al.**

Nel 1956, le mani sapienti degli artigiani che intrecciavano il filo in plastica su telai di acciaio creavano una piccola icona delle sedute italiane, la poltroncina 001. Era la nascita di Metalmobil e l'inizio di un percorso felice, guidato da uno sguardo verso il futuro che lentamente, giorno dopo giorno, diventava più chiaro, attraverso una visione sempre più affilata e a fuoco su un obiettivo: il design.

Oggi, quello che un tempo era un obiettivo, è un presupposto: design come principio primo, motore di ogni pensiero e di ogni azione, scelta etica ed estetica, orizzonte di pensiero che ha la sua forza vitale nell'ascolto degli altri.

Per questo, Metalmobil diventa **Et al.**

In letteratura, **Et al.** significa "e altri" (dal latino *et alii*), in riferimento a tutti i co-autori di un'opera.

Et al. è un ecosistema aperto, aggregante, che si arricchisce continuamente grazie alla partecipazione di progettisti affermati ed emergenti nello scenario internazionale.

Metalmobil diventa **Et al.** a compimento di un percorso identitario che disegna nuovi paesaggi, dove il punto finale è in realtà una nuova partenza.

Metalmobil diventa **Et al.** e affida a queste quattro lettere il compito di portare nel futuro le radici di un territorio unico al mondo, tra la Romagna e le Marche, dove mare e colline si incontrano, e dove saper fare artigiano e cultura industriale si fondono, per migliorare la qualità della vita delle persone.

Benvenuti in **Et al.**

Metalmobil is now **Et al.**

In 1956, the skilful hands of the craftsmen who wove plastic wire onto steel frames created an iconic little Italian seat, the 001 armchair. This was the birth of Metalmobil and the start of a successful journey, guided with an eye to the future that slowly, day by day, became clearer, and with a vision that became sharper and sharper and focused on one objective: design.

Today, what was once an objective is now a prerequisite: design is our guiding principle, which drives every thought and every action, an ethical and aesthetic choice, the reference point of our thoughts, whose vitality lies in listening to others.

This is why Metalmobil is now **Et al.**

In literature, **Et al.** means "and others" (from the Latin *et alii*), referring to all the co-authors of a work.

Et al. is an open ecosystem, which brings people together and is continually enriched by the involvement of recognised and emerging designers on the international stage.

Metalmobil is becoming **Et al.** as the fulfilment of a journey to discover its identity creating new landscapes, where the end point is actually a new beginning. Metalmobil is becoming **Et al.** and is entrusting these four letters with the task of carrying into the future the roots of a unique region, between Romagna and Marche, where sea and hills meet and where craftsmanship and industrial culture come together, improving quality of life.

Welcome to **Et al.**

Metalmobil devient **Et al.**

En 1956, les mains habiles des artisans, qui tressaient un fil en plastique sur des châssis d'acier, créaient une petite icône des chaises italiennes : le fauteuil 001. C'était la naissance de Metalmobil et le début d'un parcours heureux, guidé par un regard tourné vers l'avenir qui lentement, jour après jour, devenait plus clair, à travers une vision toujours plus nette et concentrée sur un objectif : le design.

Aujourd'hui, ce qui était auparavant un objectif est un présumé : le design comme principe premier, moteur de chaque pensée et de chaque action, choix éthique et esthétique, horizon de pensée dont la force vitale réside dans l'écoute des autres.

Et c'est pourquoi Metalmobil devient **Et al.**

En littérature, **Et al.** signifie « et autres » (du latin *et alii*), en référence à tous les co-auteurs d'un ouvrage.

Et al. est un écosystème ouvert, agrégatif, qui s'enrichit en permanence grâce à la participation de concepteurs confirmés et émergents de la scène internationale.

Metalmobil devient **Et al.** au terme d'un parcours identitaire qui dessine de nouveaux paysages, où le point final est en réalité un nouveau départ.

Metalmobil devient **Et al.** et confie à ces quatre lettres la tâche de porter dans le futur les racines d'un territoire unique au monde, entre la Romagna et les Marches, où se rencontrent mer et collines et où se fondent savoir-faire artisanal et culture industrielle, pour améliorer la qualité de vie des gens.

Bienvenue chez **Et al.**

Metalmobil heißt jetzt **Et al.**

Im Jahr 1956 schufen geschickte Kunsthandwerker, die Geflechte aus Kunststoffgarn auf Stahlrahmen herstellten, mit dem Sessel 001 eine kleine Legende der italienischen Sitzkultur. So entstand Metalmobil und es begann ein erfolgreicher, zukunftsorientierter Werdegang, der sich dank dem zunehmend starken Fokus auf das Ziel, Designprodukte zu kreieren, Tag für Tag klarer abzeichnete.

Das, was damals ein Ziel war, ist heute eine Grundvoraussetzung – Design als Grundprinzip und Impuls für jeden Gedanken, jede Umsetzung, jede Entscheidung auf ethischer und ästhetischer Ebene sowie als Horizont einer Philosophie, deren besondere Stärke in der Fähigkeit liegt, anderen zuzuhören. Aus diesem Grund erhält Metalmobil den neuen Namen **Et al.**

In der Literatur steht **Et al.** für „und andere“ (aus dem Lateinischen „et alii“), mit dem in Bibliographien auf die Mitwirkung weiterer Autoren hingewiesen wird.

Et al. ist ein offener, synergischer Zusammenschluss, der durch die Mitarbeit renommierter Designer wie junger Talente im internationalen Panorama kontinuierlich bereichert und erweitert wird.

Der neue Name **Et al.** von Metalmobil steht für eine weitere Etappe auf dem Weg zu einer von Vielfalt geprägten Identität, bei der jedes erreichte Ziel einen neuen Startpunkt skizziert.

Mit den vier Buchstaben **Et al.** möchte Metalmobil die Wurzeln einer weltweit einzigartigen Region in die Zukunft führen, der Region zwischen Romagna und den Marken, zwischen Hügellandschaft und Küste, in der Kunsthandwerk und Industriekultur harmonisch miteinander verschmelzen, um die Lebensqualität des Menschen zu verbessern.

Herzlich willkommen bei **Et al.**



Metalmobil se convierte en **Et al.**

En 1956, las expertas manos de los artesanos que trenzaban un hilo de plástico en bastidores de acero creaban un icono del asiento italiano, el sillón 001. Era el nacimiento de Metalmobil y el principio de una andadura feliz, guiada por una mirada hacia el futuro que lentamente, día tras día, se afianzaba a través de una visión cada vez más clara y enfocada en un objetivo: el diseño.

Lo que antaño era un objetivo hoy se ha convertido en un presupuesto: diseño como principio primordial, motor de todo pensamiento y de toda acción, elección ética y estética, horizonte de pensamiento cuya fuerza vital radica en escuchar a los demás.

Por esto, Metalmobil se convierte en **Et al.**

En la literatura, **Et al.** significa «y otros» (del latín *et alii*), para indicar a todos los coautores de una obra.

Et al. es un ecosistema abierto, aglutinador, que se enriquece continuamente gracias a la participación de diseñadores renombrados y emergentes del escenario internacional.

Metalmobil se convierte en **Et al.** para completar un recorrido identitario que dibuja nuevos paisajes y cuyo punto final es, en realidad, un nuevo comienzo.

Metalmobil se convierte en **Et al.** y otorga a estas cuatro letras la tarea de llevar hasta el futuro las raíces de un territorio único en el mundo ubicado entre Romaña y Las Marcas, allí donde el mar y las montañas se encuentran y donde el saber artesanal y la cultura industrial se funden para mejorar la calidad de vida de las personas.

Bienvenidos a **Et al.**

sommario / index / index /
index / índice



12 **palau**
design
Marc Sadler



46 **pif**
design
Marc Sadler



106 **nomad**
design
rdm



130 **to-kyo**
design
Makio Hasuike & Co.



20 **pillow**
design
Andrea Anastasio



50 **nassau**
design
Marc Sadler



110 **flint**
design
Marc Sadler



138 **marè**
design
Marc Sadler



24 **hull**
design
Harri Koskinen



62 **dalton**
design
Giulio Iacchetti



114 **stripes**
design
Talocci Design



144 **uni-ka**
design
rdm

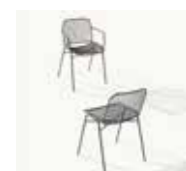

30 **shade**
design
Philippe Nigro



72 **myra**
design
Emilio Nanni



120 **play**
design
Radice Orlandini Design Studio



164 **kontea**
design
Carlo Bimbi Design



36 **cuba**
design
Marc Sadler



98 **ring**
design
Radice Orlandini Design Studio



124 **bikini**
design
Marc Sadler



168 **kyk**
design
Carlo Bimbi Design



172 **abaco+**
design
rdm



190 **uni**
design
Francesco Geraci



236 **echo**
design
rdm



258 **ibis**
design
Francesco Geraci



176 **playa**
design
Carlo Bimbi Design



218 **agatha**
design
rdm



242 **kicca**
design
Francesco Geraci



264 **boom**
design
Emilio Nanni



180 **zero**
design
Carlo Bimbi Design



224 **duo**
design
Franco Bertoli & Max Pajetta



246 **net**
design
Francesco Geraci



268 **space**
design
rdm



184 **marka**
design
Carlo Bimbi Design



226 **punto**
design
Francesco Geraci



250 **apple**
design
Egidio Panzera



276 **001**
design
rdm



188 **sharing**
design
Giorgio Di Tullio



230 **abaco**
design
rdm



254 **luna**
design
rdm



278 **salinero**
design
Giulio Iacchetti

elenco alfabetico / alphabetical list /
 liste alphabétique / alphabetische
 liste / lista alfabética



284 **dalton**
 design
 Giulio Iacchetti



294 **jet**
 design
 rdm

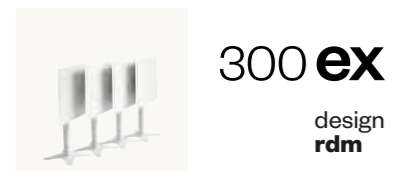

300 **ex**
 design
 rdm

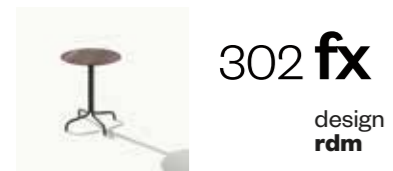

302 **fx**
 design
 rdm

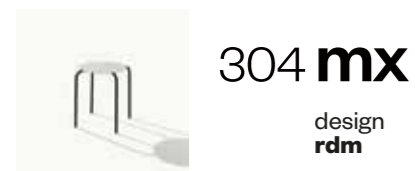

304 **mx**
 design
 rdm

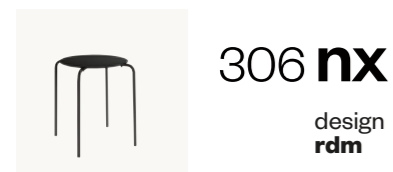

306 **nx**
 design
 rdm

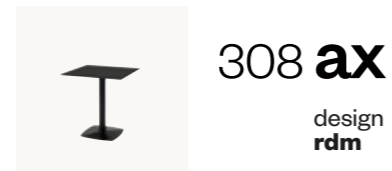

308 **ax**
 design
 rdm

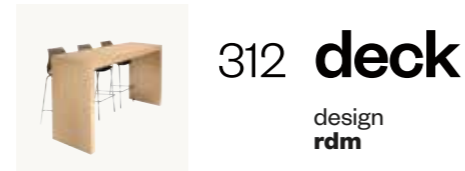

312 **deck**
 design
 rdm

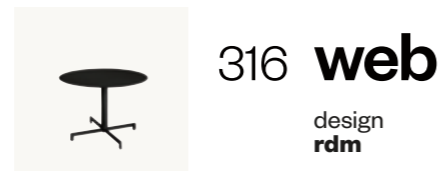

316 **web**
 design
 rdm

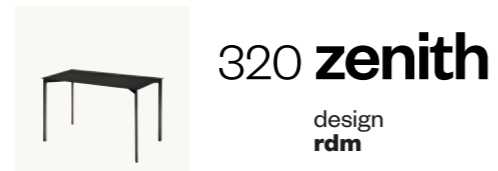

320 **zenith**
 design
 rdm



322 **mt**
 design
 rdm



330 **xt**
 design
 rdm

O
 001 276

- a**
 abaco 230
 abaco+ 172
 agatha 218
 apple 250
 ax 308

- b**
 bikini 124
 boom 264

- c**
 cuba 36

- d**
 dalton 62
 dalton 284
 deck 312
 duo 224

- e**
 echo 236
 ex 300

- f**
 flint 110
 fx 302

- h**
 hull 24

- i**
 ibis 258

j
 jet 294

- k**
 kicca 242
 kontea 164
 kyk 168

- l**
 luna 254

- m**
 maré 138
 marka 184
 mt 322
 mx 304
 myra 72

- n**
 nassau 50
 net 246
 nomad 106
 nx 306

- p**
 palau 12
 pif 46
 pillow 20
 play 120
 playa 176
 punto 226

- r**
 ring 98

- s**
 salinero 278
 shade 30
 sharing 188
 space 268
 stripes 114

- t**
 to-kyo 130

- u**
 uni 190
 uni-ka 144

- w**
 web 316

- x**
 xt 330

- z**
 zenith 320
 zero 180

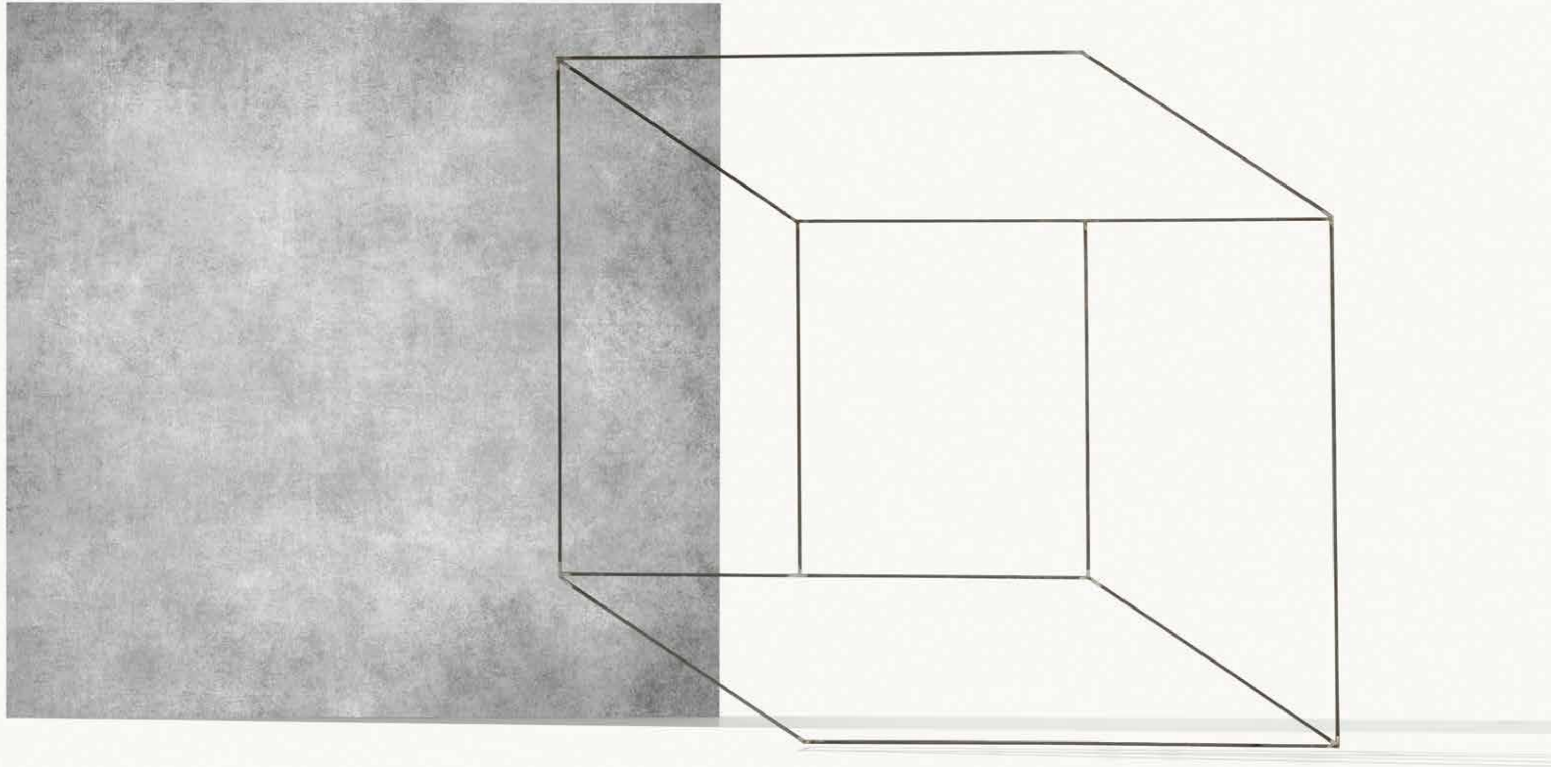

palau

design
Marc Sadler, 2019



1020

- > Sedia monoblocco in polipropilene, stampata a iniezione con tecnologia air moulding.
- > Monobloc chair in polypropylene made using the injected air moulding technology.
- > Chaise en polypropylène monobloc, moulée sous injection avec gaz air moulding.
- > Stuhl aus nur einem einzigen Teil aus Polypropylen, mit der Air-Moulding-Technologie injektionsgepresst.
- > Silla monobloque en polipropileno moldeada por inyección con tecnología air moulding.

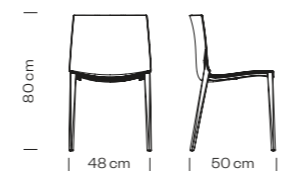

Peso / Weight / Poids / Gewicht / Peso **3,8 kg**

Imballo / Packaging / Emballage / Verpackung / Embalaje **0,31 m³**

Pezzi per scatola / Pieces for box / Pièces par carton / Stücke in einem Karton / Piezas por caja **4**

Impilabile / Stackable / Empilable / Stapelbar / Apilable **6**



1021

- > Sedia monoblocco con braccioli in polipropilene, stampata a iniezione con tecnologia air moulding.
- > Monobloc armchair in polypropylene made using the injected air-moulding technology.
- > Fauteuil en polypropylène monobloc, moulée sous injection avec gaz air moulding.
- > Armlehnstuhl aus nur einem einzigen Teil aus Polypropylen, mit der Air-Moulding-Technologie injektionsgepresst.
- > Silla monobloque en polipropileno con brazos moldeada por inyección con tecnología air moulding.

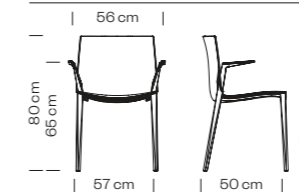

Peso / Weight / Poids / Gewicht / Peso **4,1 kg**

Imballo / Packaging / Emballage / Verpackung / Embalaje **0,36 m³**

Pezzi per scatola / Pieces for box / Pièces par carton / Stücke in einem Karton / Piezas por caja **4**

Impilabile / Stackable / Empilable / Stapelbar / Apilable **6**

PP

- > Finiture seduta
- > Seat finishes
- > Finitions de l'assise
- > Sitzfertigung
- > Acabados asiento



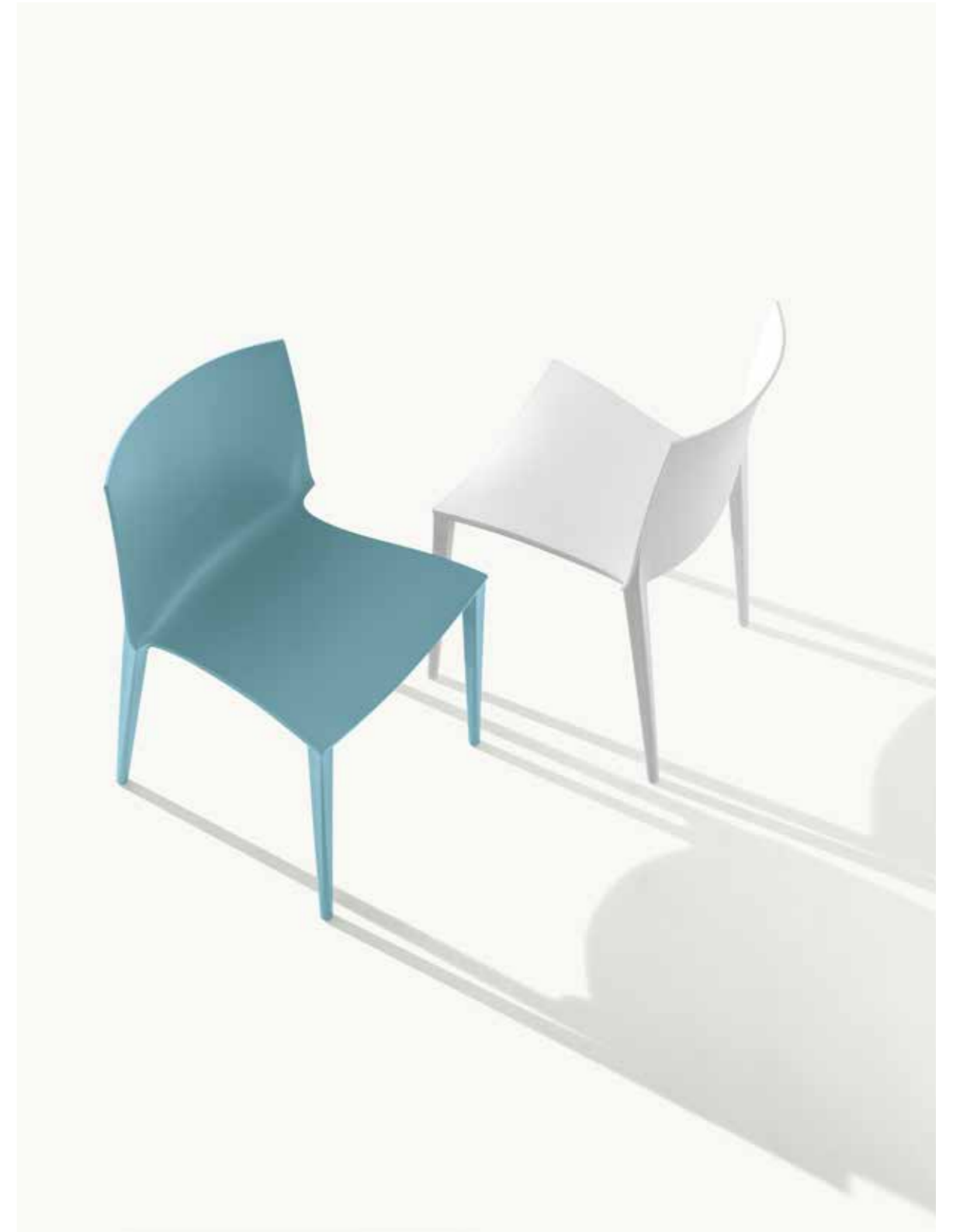





pillow

design
Andrea Anastasio, 2018



219

- > Pouf imbottito con rivestimento in tessuto.
- > Upholstered pouf.
- > Pouf rembourrée.
- > Gepolsterer Hocker.
- > Pouf tapizado.

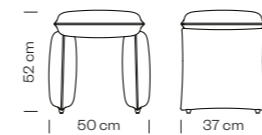

Peso / Weight /
Poids / Gewicht / Peso **5,1 kg**

Imballo / Packaging
Emballage / Verpackung /
Embalaje **0,12 m³**

Pezzi per scatola /
Pieces for box /
Pièces par carton /
Stücke in einem Karton /
Piezas por caja **1**



TE

- > Finiture seduta
(vedi p. 359)
- > Seat finishes
(see p. 359)
- > Finitions de l'assise
(voir p. 359)
- > Sitzfertigung
(sehen S. 359)
- > Acabados asiento
(ver p. 359)



hull

design
Harri Koskinen, 2018



627

- > Sedia con telaio 4 gambe in tubo acciaio, seduta e schienale in faggio (finitura gofrata).
- > Chair with 4 legs steel frame. Beech wood seat and back (embossed finish).
- > Chaise avec châssis 4 pieds en acier. Assise et dossier en hêtre (finition gofré).
- > Stuhl mit 4-beinigem Stahlgestell. Sitzfläche und Rückenlehne aus Buchenholz (geprägte Ausführung).
- > Silla con estructura tubular 4 patas en acero. Asiento y respaldo en madera de haya (acabado gofrado).

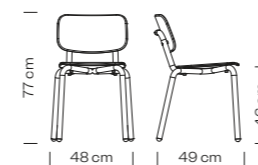

Peso / Weight / Poids / Gewicht / Peso **5,2 kg**

Imballo / Packaging
Emballage / Verpackung / Embalaje **0,39 m³**

Pezzi per scatola / Pieces for box / Pièces par carton / Stücke in einem Karton / Piezas por caja **4**

Impilabile / Stackable / Empilable / Stapelbar / Apilable **4**



628

- > Sedia con telaio 4 gambe in tubo acciaio, con braccioli, seduta e schienale in faggio (finitura gofrata).
- > Chair with armrests and steel frame, 4 legs. Beech wood seat and back (embossed finish).
- > Chaise avec châssis 4 pieds en acier, avec accoudoirs, assise et dossier en hêtre (finition gofré).
- > Stuhl mit 4-beinigem Stahlgestell, mit Armlehnen. Sitzfläche und Rückenlehne aus Buchenholz (geprägte Ausführung).
- > Silla con estructura tubular 4 patas en acero, con brazos, asiento y respaldo en madera de haya (acabado gofrado).

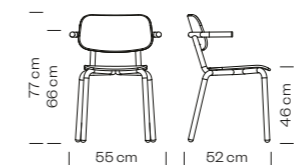

Peso / Weight / Poids / Gewicht / Peso **5,7 kg**

Imballo / Packaging
Emballage / Verpackung / Embalaje **0,45 m³**

Pezzi per scatola / Pieces for box / Pièces par carton / Stücke in einem Karton / Piezas por caja **4**

Impilabile / Stackable / Empilable / Stapelbar / Apilable **4**



629

- > Sedia con telaio 4 gambe in tubo acciaio, con braccioli, seduta e schienale in faggio (finitura gofrata).
- > Chair with armrests and steel frame, 4 legs. Beech wood seat and back (embossed finish).
- > Chaise avec châssis 4 pieds en acier, avec accoudoirs, assise et dossier en hêtre (finition gofré).
- > Stuhl mit 4-beinigem Stahlgestell, mit Armlehnen. Sitzfläche und Rückenlehne aus Buchenholz (geprägte Ausführung).
- > Silla con estructura tubular 4 patas en acero, con brazos, asiento y respaldo en madera de haya (acabado gofrado).

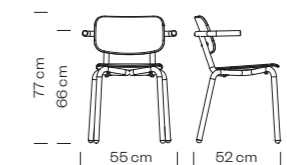

Peso / Weight / Poids / Gewicht / Peso **6,4 kg**

Imballo / Packaging
Emballage / Verpackung / Embalaje **0,45 m³**

Pezzi per scatola / Pieces for box / Pièces par carton / Stücke in einem Karton / Piezas por caja **4**

Impilabile / Stackable / Empilable / Stapelbar / Apilable **4**

AC

- > Finiture telaio (vedi p. 395)
- > Frame finishes (see p. 395)
- > Finitions piètement (voir p. 395)
- > Gestell fertigungen (sehen S. 395)
- > Acabados estructura (ver p. 395)

LE

- > Finiture seduta
Legno faggio (finitura gofrata)
- > Seat finishes
Beech wood (embossed finish)
- > Finitions de l'assise
Bois hêtre (finition gofré)
- > Sitzfertigung
Buchenholz (geprägte Ausführung)
- > Acabados asiento
Madera de haya (acabado gofrado)







shade

design
Philippe Nigro, 2018



625

- > Sedia con telaio a 4 gambe in tubo acciaio. Seduta e schienale in tondino acciaio.
- > Chair with 4 legs steel frame. Seat and back in steel frame.
- > Chaise avec châssis 4 pieds en acier. Assise et dossier en fil d'acier.
- > Stuhl mit 4-beinigem Stahlgestell. Sitzfläche und Rückenlehne aus elektroverschweissten Stahlrohren.
- > Silla con estructura tubular 4 patas en acero. Asiento y respaldo en acero.



626

- > Sedia con telaio a 4 gambe in tubo acciaio. Seduta e schienale in tondino acciaio.
- > Chair with 4 legs steel frame. Seat and back in steel frame.
- > Chaise avec châssis 4 pieds en acier. Assise et dossier en fil d'acier.
- > Stuhl mit 4-beinigem Stahlgestell. Sitzfläche und Rückenlehne aus elektroverschweissten Stahlrohren.
- > Silla con estructura tubular 4 patas en acero. Asiento y respaldo en acero.



624

- > Sgabello con telaio a 4 gambe in tubo acciaio. Seduta e schienale in tondino acciaio.
- > Barstool with 4 legs steel frame. Seat and back in steel frame.
- > Tabouret avec châssis 4 pieds en acier. Assise et dossier en fil d'acier.
- > Barhocker mit 4-beinigem Stahlgestell. Sitzfläche und Rückenlehne aus elektroverschweissten Stahlrohren.
- > Taburete con estructura tubular 4 patas en acero. Asiento y respaldo en acero.



624B

- > Sgabello con telaio a 4 gambe in tubo acciaio. Seduta e schienale in tondino acciaio. Seduta: H 65 cm.
- > Barstool with 4 legs steel frame. Seat and back in steel frame. Seat-height: H 65.
- > Tabouret avec châssis 4 pieds en acier. Assise et dossier en fil d'acier. Hauteur assise: H 65 cm.
- > Barhocker mit 4-beinigem Stahlgestell. Sitzfläche und Rückenlehne aus elektroverschweissten Stahlrohren. Sitzhöhe: H 65 cm.
- > Taburete con estructura tubular 4 patas en acero. Asiento y respaldo en acero. Altura asiento 65 cm.



Peso / Weight / Poids / Gewicht / Peso **6,3 kg**

Imballo / Packaging / Emballage / Verpackung / Embalaje **0,35 m³**

Pezzi per scatola / Pieces for box / Pièces par carton / Stücke in einem Karton / Piezas por caja **4**

Impilabile / Stackable / Empilable / Stapelbar / Apilable **8**

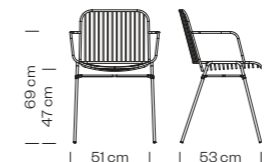

Peso / Weight / Poids / Gewicht / Peso **7,2 kg**

Imballo / Packaging / Emballage / Verpackung / Embalaje **0,39 m³**

Pezzi per scatola / Pieces for box / Pièces par carton / Stücke in einem Karton / Piezas por caja **4**

Impilabile / Stackable / Empilable / Stapelbar / Apilable **8**

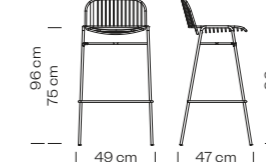

Peso / Weight / Poids / Gewicht / Peso **6,8 kg**

Imballo / Packaging / Emballage / Verpackung / Embalaje **0,35 m³**

Pezzi per scatola / Pieces for box / Pièces par carton / Stücke in einem Karton / Piezas por caja **2**

Impilabile / Stackable / Empilable / Stapelbar / Apilable **6**



Peso / Weight / Poids / Gewicht / Peso **6,6 kg**

Imballo / Packaging / Emballage / Verpackung / Embalaje **0,33 m³**

Pezzi per scatola / Pieces for box / Pièces par carton / Stücke in einem Karton / Piezas por caja **2**

Impilabile / Stackable / Empilable / Stapelbar / Apilable **6**

AC

- > Finiture seduta
(vedi p. 358)
- > Seat finishes
(see p. 358)
- > Finitions de l'assise
(voir p. 358)
- > Sitzfertigung
(sehen S. 358)
- > Acabados asiento
(ver p. 358)

Accessori / Accessories / Accessoires / Zubehoer / Accesorios

- > Cuscino in tessuto impermeabile
per esterno (da rimuovere in caso
di pioggia)
- > Waterproof fabric cushion for
outdoors (to be removed in case of
bad weather)
- > Coussin en tissu impermeable
pour l'exterieur (a rentrer en cas de
intemperies)
- > Kissen Wasserdichtes Gewebe für
den Außenbereich (im Falle von
Regen zu entfernen)
- > Cojin en tejido impermeable para
exteriores (por removerse en caso
de lluvia)

Finiture / Finishes / Finitions / Fertigungen / Acabados



1004 Bruma Grafito



1007 Bruma Niebla





cuba

design
Marc Sadler, 2017



620

- > Sedia con telaio a 4 gambe in tubo acciaio. Seduta in polipropilene.
- > Chair with steel frame, 4 legs. Polypropylene shell.
- > Chaise avec châssis en acier 4 pieds et coque en polypropylène.
- > Stuhl mit 4-beinigem Stahlgestell. Sitzfläche aus Polypropylen.
- > Silla con estructura tubular 4 patas en acero, carcasa en polipropileno.



620N

- > Sedia con telaio a 4 gambe in tubo acciaio e seduta in polipropilene. Sedile imbottito rivestito in tessuto.
- > Chair with steel frame, 4 legs. Upholstered seat.
- > Chaise avec châssis en acier 4 pieds et coque en polypropylène. Assise rembourrée.
- > Stuhl mit 4-beinigem Stahlgestell. Schale aus Polypropylen. Gepolsterte Sitzfläche.
- > Silla con estructura tubular 4 patas en acero y carcasa en polipropileno. Asiento tapizado.



621

- > Sedia con telaio a 4 gambe in tubo acciaio, con braccioli. Seduta in polipropilene.
- > Chair with armrests and steel frame, 4 legs. Polypropylene shell.
- > Chaise avec châssis en acier 4 pieds et accoudoirs. Coque en polypropylène.
- > Armlehnstuhl mit 4-beinigem Stahlgestell. Sitzfläche aus Polypropylen.
- > Silla con estructura tubular 4 patas en acero con brazos, carcasa en polipropileno.



621N

- > Sedia con telaio a 4 gambe in tubo acciaio, con braccioli. Seduta in polipropilene. Sedile imbottito rivestito in tessuto.
- > Chair with armrests and steel frame, 4 legs. Polypropylene shell. Upholstered seat.
- > Chaise avec châssis en acier 4 pieds et accoudoirs. Coque en polypropylène. Assise rembourrée.
- > Armlehnstuhl mit 4-beinigem Stahlgestell. Schale aus Polypropylen. Gepolsterte Sitzfläche.
- > Silla con estructura tubular 4 patas en acero con brazos, carcasa en polipropileno. Asiento tapizado.

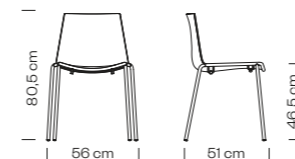

Peso / Weight / Poids / Gewicht / Peso **5,4 kg**

Imballo / Packaging / Emballage / Verpackung / Embalaje **0,39 m³**

Pezzi per scatola / Pieces per box / Pièces par carton / Stücke in einem Karton / Piezas por caja **4**

Impilabile / Stackable / Empilable / Stapelbar / Apilable **8**

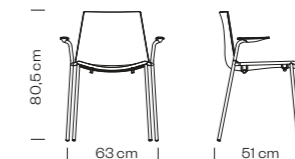

Peso / Weight / Poids / Gewicht / Peso **5,8 kg**

Imballo / Packaging / Emballage / Verpackung / Embalaje **0,47 m³**

Pezzi per scatola / Pieces per box / Pièces par carton / Stücke in einem Karton / Piezas por caja **4**

Impilabile / Stackable / Empilable / Stapelbar / Apilable **7**

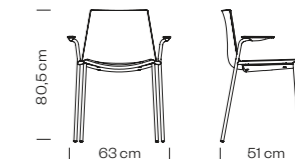

Peso / Weight / Poids / Gewicht / Peso **6,3 kg**

Imballo / Packaging / Emballage / Verpackung / Embalaje **0,47 m³**

Pezzi per scatola / Pieces per box / Pièces par carton / Stücke in einem Karton / Piezas por caja **4**

Impilabile / Stackable / Empilable / Stapelbar / Apilable **4**



622

- > Sedia con telaio a slitta in tondino acciaio. Seduta in polipropilene.
- > Chair with sled steel frame. Polypropylene shell.
- > Chaise avec châssis en fil d'acier pied luge. Coque en polypropylène.
- > Stuhl mit Kufengestell aus Stahlstangen. Sitzfläche aus Polypropylen.
- > Silla con estructura patín en acero, carcasa en polipropileno.



622N

- > Sedia con telaio a slitta in tondino acciaio e seduta in polipropilene. Sedile imbottito rivestito in tessuto.
- > Chair with sled steel frame. Polypropylene shell. Upholstered seat.
- > Chaise avec châssis en fil d'acier pied luge. Coque en polypropylène. Assise rembourrée.
- > Stuhl mit Kufengestell aus Stahlstangen. Schale aus Polypropylen. Gepolsterte Sitzfläche.
- > Silla con estructura patín en acero, carcasa en polipropileno. Asiento tapizado.



623

- > Sgabello con telaio a 4 gambe in tubo acciaio. Seduta in polipropilene.
- > Barstool with steel frame, 4 legs. Polypropylene shell.
- > Tabouret avec chassis 4 pieds en acier. Coque en polypropylène.
- > Barhocker mit 4-beinigem Stahlgestell. Schale aus Polypropylen.
- > Taburete con estructura tubular 4 patas en acero, carcasa en polipropileno.



623B

- > Sgabello con telaio a 4 gambe in tubo acciaio. Seduta in polipropilene. Seduta: H 65 cm.
- > Barstool with steel frame, 4 legs. Polypropylene shell. Seat-height: H 65.
- > Tabouret avec chassis 4 pieds en acier. Coque en polypropylène. Hauteur assise: H 65 cm.
- > Barhocker mit 4-beinigem Stahlgestell. Schale aus Polypropylen. Sitzhöhe: H 65 cm.
- > Taburete con estructura tubular 4 patas en acero, carcasa en polipropileno. Altura asiento 65 cm.



536

- > Carrello per 10 Cuba 620 / 10 Cuba 621 / 16 Cuba 622
- > Trolley for 10 Cuba 620 / 10 Cuba 621 / 16 Cuba 622
- > Chariot pour 10 Cuba 620 / 10 Cuba 621 / 16 Cuba 622
- > Transportwagen für 10 Cuba 620 / 10 Cuba 621 / 16 Cuba 622
- > Carrito por 10 Cuba 620 / 10 Cuba 621 / 16 Cuba 622

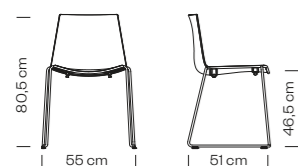

Peso / Weight / Poids / Gewicht / Peso **6,6 kg**

Imballo / Packaging / Emballage / Verpackung / Embalaje **0,39 m³**

Pezzi per scatola / Pieces per box / Pièces par carton / Stücke in einem Karton / Piezas por caja **4**

Impilabile / Stackable / Empilable / Stapelbar / Apilable **10**

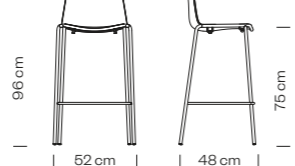

Peso / Weight / Poids / Gewicht / Peso **6,3 kg**

Imballo / Packaging / Emballage / Verpackung / Embalaje **0,36 m³**

Pezzi per scatola / Pieces per box / Pièces par carton / Stücke in einem Karton / Piezas por caja **4**

Impilabile / Stackable / Empilable / Stapelbar / Apilable **8**

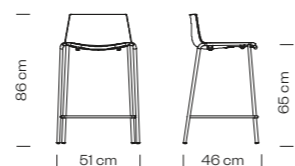

Peso / Weight / Poids / Gewicht / Peso **6 kg**

Imballo / Packaging / Emballage / Verpackung / Embalaje **0,36 m³**

Pezzi per scatola / Pieces per box / Pièces par carton / Stücke in einem Karton / Piezas por caja **4**

Impilabile / Stackable / Empilable / Stapelbar / Apilable **8**



Accessori / Accessories / Accessoires / Zubehoer / Accesorios

- > Pedana in lamiera per impilabilità sedie 620/621: impilabilità fino a 10 pz.
- > Metal plate support for 620/621: Stacks 10 pcs.
- > Support fixe pour chaise 620/621: permet d'empiler jusqu'à 10 pieces.
- > Sockel aus Blech zum Stapeln von Stühlen 620/621: Stapeln bis zu 10 Stück.
- > Plataforma de chapa para apilamiento sillas 620/621: apilables hasta 10 piezas.



Accessori / Accessories / Accessoires / Zubehoer / Accesorios

- > Sistema di aggancio 622 / 622N: Kit composto da 4 agganci (2 maschi e 2 femmine).
- > Linking device 622 / 622N: Kit composed by 4 pcs (2 male and 2 female).
- > Système d'accrochage 622 / 622N: kit composé par 4 pièces (2 mâles et 2 femelles).
- > Kupplungssystem 622 / 622N: Set bestehend aus 4 Haken (2 männlicher und 2 weiblicher Haken).
- > Sistema de enganche 622 / 622N: Kit compuesto por 4 enganches (2 machos y 2 hembras).

AC

- > Finiture telaio (vedi p. 395)
- > Frame finishes (see p. 395)
- > Finitions piètement (voir p. 395)
- > Gestell fertigungen (sehen S. 395)
- > Acabados estructura (ver p. 395)

TE

- > Finiture seduta (vedi p. 359)
- > Seat finishes (see p. 359)
- > Finitions de l'assise (voir p. 359)
- > Sitzfertigung (sehen S. 359)
- > Acabados asiento (ver p. 359)

PP

- > Finiture seduta
- > Seat finishes
- > Finitions de l'assise
- > Sitzfertigung
- > Acabados asiento









pif

design
Marc Sadler, 2017

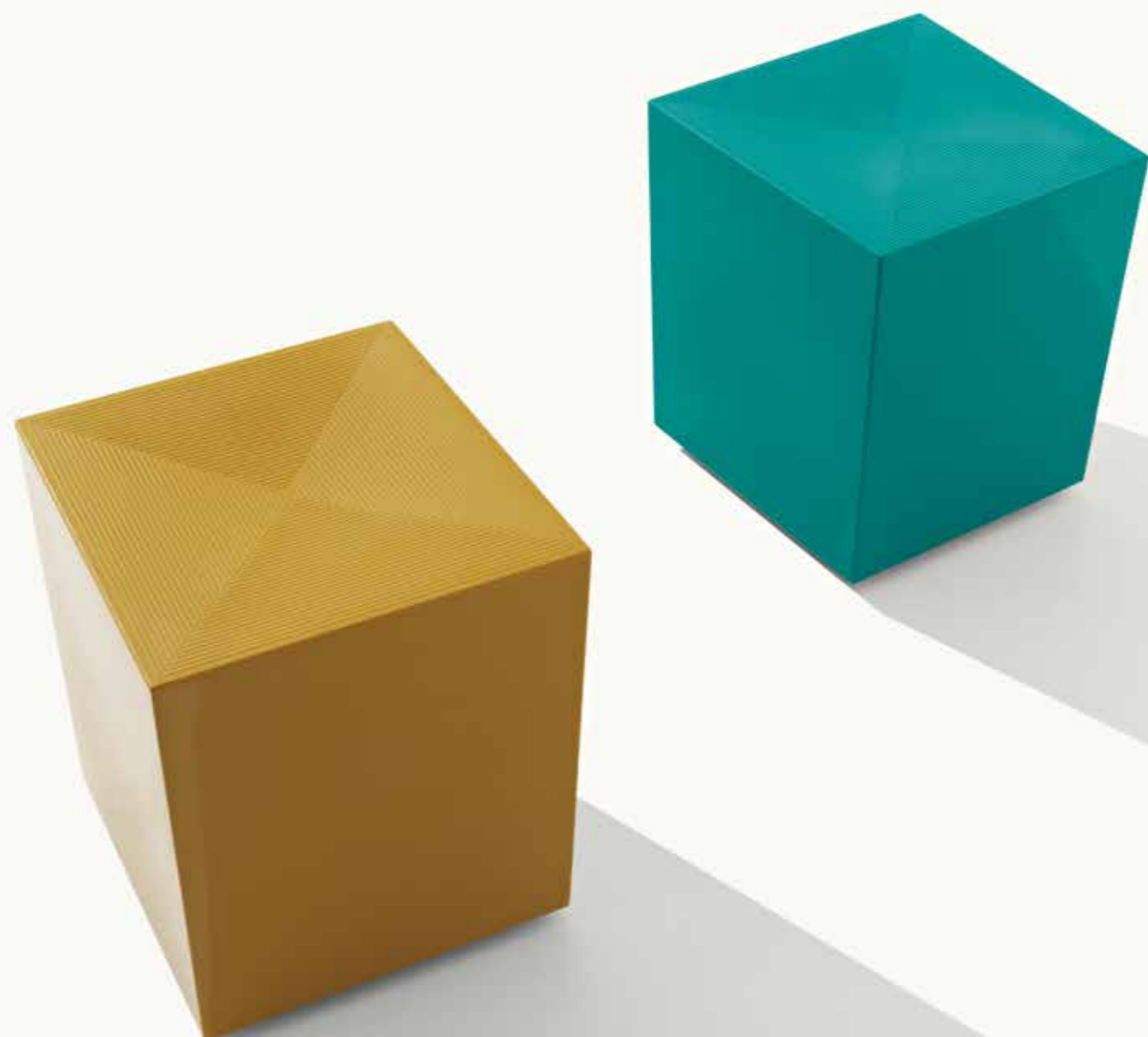

211

- > Pouf in polietilene stampato in rotazionale.
- > Pouf in polyethylene, rotational moulding.
- > Pouf en polyéthylène roto-moulé.
- > Hocker aus Rotationsverfahren gepresstem Polyäthylen.
- > Pouf en polietileno moldeado rotativo.

PE

- > Finiture seduta
- > Seat finishes
- > Finitions de l'assise
- > Sitzfertigung
- > Acabados asiento



Peso / Weight / Poids / Gewicht / Peso **4 kg**

Imballo / Packaging / Emballage / Verpackung / Embalaje **0,08 m³**

Pezzi per scatola / Pieces per box / Pièces par carton / Stücke in einem Karton / Piezas por caja **1**





nassau

design
Marc Sadler, 2016



533

- > Sedia monoblocco in polipropilene, stampata a iniezione con tecnologia air moulding.
- > Monobloc chair in polypropylene made using the injected air-moulding technology.
- > Chaise, en polypropylène monobloc, moulée sous injection avec gaz air moulding.
- > Stuhl aus nur einem einzigen Teil aus Polypropylen, mit der Air-Moulding-Technologie injektionsgepresst.
- > Silla en polipropileno a inyección con tecnología air moulding.



533M

- > Sedia monoblocco in polipropilene con rivestimento in tessuto, stampata a iniezione con tecnologia air moulding.
- > Monobloc chair in polypropylene with upholstery made using the injected air-moulding technology.
- > Chaise, en polypropylène monobloc avec rembourrage, moulée sous injection avec gaz air moulding.
- > Stuhl aus nur einem einzigen Teil aus Polypropylen und Bezug aus Stoff, mit der Air-Moulding-Technologie injektionsgepresst.
- > Silla en polipropileno tapizada a inyección con tecnología air moulding.



533N

- > Sedia monoblocco in polipropilene, stampata a iniezione con tecnologia air moulding. Seduta imbottita rivestita in tessuto.
- > Monobloc chair in polypropylene made using the injected airmoulding technology. Upholstered seat.
- > Chaise, en polypropylène monobloc, moulée sous injection avec gaz air moulding. Assise rembourrée.
- > Stuhl aus nur einem einzigen Teil aus Polypropylen, mit der Air-Moulding-Technologie injektionsgepresst. Gepolsterte Sitzfläche.
- > Silla en polipropileno a inyección con tecnología air moulding. Asiento tapizado.



534

- > Sedia monoblocco con braccioli in polipropilene, stampata a iniezione con tecnologia air moulding.
- > Monobloc armchair in polypropylene made using the injected air-moulding technology.
- > Fauteuil en polypropylène monobloc, moulée sous injection avec gaz air moulding.
- > Armlehnstuhl aus nur einem einzigen Teil aus Polypropylen, mit der Air-Moulding-Technologie injektionsgepresst.
- > Silla monobloque en polipropileno con brazos moldeada por inyección con tecnología air moulding.

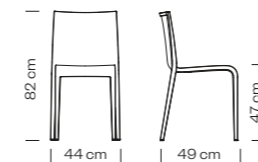

Peso / Weight / Poids / Gewicht / Peso **4,2 kg**

Imballo / Packaging / Emballage / Verpackung / Embalaje **0,35 m³**

Pezzi per scatola / Pieces for box / Pièces par carton / Stücke in einem Karton / Piezas por caja **5**

Impilabile / Stackable / Empilable / Stapelbar / Apilable **8**

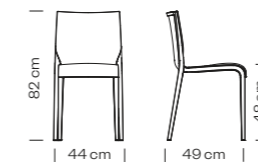

Peso / Weight / Poids / Gewicht / Peso **6,2 kg**

Imballo / Packaging / Emballage / Verpackung / Embalaje **0,27 m³**

Pezzi per scatola / Pieces for box / Pièces par carton / Stücke in einem Karton / Piezas por caja **2**

Impilabile / Stackable / Empilable / Stapelbar / Apilable **4**

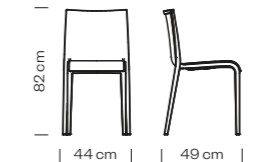

Peso / Weight / Poids / Gewicht / Peso **5,5 kg**

Imballo / Packaging / Emballage / Verpackung / Embalaje **0,27 m³**

Pezzi per scatola / Pieces for box / Pièces par carton / Stücke in einem Karton / Piezas por caja **2**

Impilabile / Stackable / Empilable / Stapelbar / Apilable **4**

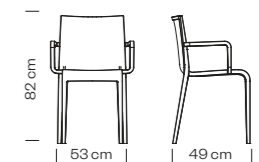

Peso / Weight / Poids / Gewicht / Peso **4,8 kg**

Imballo / Packaging / Emballage / Verpackung / Embalaje **0,39 m³**

Pezzi per scatola / Pieces for box / Pièces par carton / Stücke in einem Karton / Piezas por caja **5**

Impilabile / Stackable / Empilable / Stapelbar / Apilable **8**



534N

- > Sedia monoblocco con braccioli in polipropilene, stampata a iniezione con tecnologia air moulding. Seduta imbottita rivestita in tessuto.
- > Monobloc armchair in polypropylene made using the injected air-moulding technology. Upholstered seat.
- > Fauteuil en polypropylène monobloc, moulée sous injection avec gaz air moulding. Assise rembourrée.
- > Armlehnstuhl aus nur einem einzigen Teil aus Polypropylen, mit der Air-Moulding-Technologie injektionsgepresst. Gepolsterte Sitzfläche.
- > Silla monobloque en polipropileno con brazos moldeada por inyección con tecnología air moulding. Asiento tapizado.

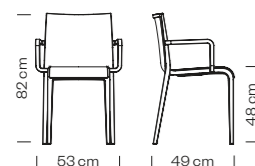

Peso / Weight / Poids / Gewicht / Peso **6 kg**

Imballo / Packaging
Emballage / Verpackung / Embalaje **0,32 m³**

Pezzi per scatola / Pieces for box / Pièces par carton / Stücke in einem Karton / Piezas por caja **2**

Impilabile / Stackable / Empilable / Stapelbar / Apilable **4**



537

- > Sgabello monoblocco in polipropilene, stampato a iniezione con tecnologia air moulding.
- > Monobloc barstool in polypropylene made using the injected air-moulding technology.
- > Tabouret en polypropylène monobloc, moulée sous injection avec gaz air moulding.
- > Barhocker aus nur einem einzigen Teil aus Polypropylen, mit der Air-Moulding-Technologie injektionsgepresst.
- > Taburete monobloque en polipropileno moldeado por inyección con tecnología air moulding.

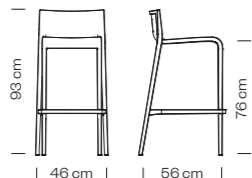

Peso / Weight / Poids / Gewicht / Peso **4,8 kg**

Imballo / Packaging
Emballage / Verpackung / Embalaje **0,35 m³**

Pezzi per scatola / Pieces for box / Pièces par carton / Stücke in einem Karton / Piezas por caja **2**

Impilabile / Stackable / Empilable / Stapelbar / Apilable **5**



537B

- > Sgabello monoblocco in polipropilene, stampato a iniezione con tecnologia air moulding. Versione seduta H 66 cm.
- > Monobloc barstool in polypropylene made using the injected air-moulding technology. Version seat-height H 66 cm.
- > Tabouret en polypropylène monobloc, moulée sous injection avec gaz air moulding. Version hauteur assise 66 cm.
- > Barhocker aus nur einem einzigen Teil aus Polypropylen, mit der Air-Moulding-Technologie injektionsgepresst. Sitzhöhe 66 cm.
- > Taburete monobloque en polipropileno moldeado por inyección con tecnología air moulding. Altura asiento 66 cm.

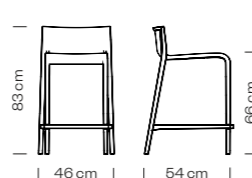

Peso / Weight / Poids / Gewicht / Peso **4,6 kg**

Imballo / Packaging
Emballage / Verpackung / Embalaje **0,31 m³**

Pezzi per scatola / Pieces for box / Pièces par carton / Stücke in einem Karton / Piezas por caja **2**

Impilabile / Stackable / Empilable / Stapelbar / Apilable **5**



536

- > Carrello per 10 Nassau 533 / 8 Nassau 534
- > Trolley for 10 Nassau 533 / 8 Nassau 534
- > Chariot pour 10 Nassau 533 / 8 Nassau 534
- > Transportwagen für 10 Nassau 533 / 8 Nassau 534
- > Carrito por 10 Nassau 533 / 8 Nassau 534

TE

- > Finiture seduta (vedi p. 359)
- > Seat finishes (see p. 359)
- > Finitions de l'assise (voir p. 359)
- > Sitzfertigung (sehen S. 359)
- > Acabados asiento (ver p. 359)

PP

- > Finiture seduta
- > Seat finishes
- > Finitions de l'assise
- > Sitzfertigung
- > Acabados asiento



- > Nassau 533 nella versione ignifuga è disponibile nel colore Bianco puro RAL 9010.
- > Nassau 533 in the fire retardant version is available only in Pure white RAL 9010.
- > Nassau 533 version ignifugé est disponible uniquement en Blanc pur RAL 9010.
- > Nassau 533 in der schwer entflammbar Ausführung ist nur in den Farbe Reinweiß RAL 9010 verfügbar.
- > Nassau 533 en la versión ignifuga es disponible solamente en color Blanco puro RAL 9010.

* Non disponibile per / Not available for / Pas disponible pour / Nicht verfügbar für / No disponible para 537, 537B











dalton

design
Giulio lacchetti, 2016



661

- > Sedia con seduta e schienale in frassino rivestiti in tessuto, telaio 4 gambe in frassino. Versione con schienale basso.
- > 4-leg chair with ash wood frame. Upholstered seat and back. Version with low backrest.
- > Chaise avec assise et dossier en bois revêtus en tissu, châssis 4 pieds en frêne ; version avec dossier bas.
- > Stuhl mit gepolsterten Sitzfläche und Rückenlehne aus Esche, Gestell aus 4-beinigem Eschenholz. Ausführung mit niedrigem Rückenlehne.
- > Silla con estructura 4 patas en madera de fresno. Asiento y respaldo en madera de fresno tapizados. Versión con respaldo bajo.

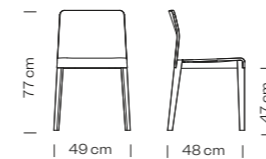

Peso / Weight / Poids / Gewicht / Peso **7,2 kg**

Imballo / Packaging / Emballage / Verpackung / Embalaje **0,24 m³**

Pezzi per scatola / Pieces per box / Pièces par carton / Stücke in einem Karton / Piezas por caja **1**



662

- > Sedia con seduta e schienale in frassino rivestiti in tessuto, telaio 4 gambe in frassino. Versione con schienale alto.
- > 4-leg chair with ash wood frame. Upholstered seat and back. Version with high backrest.
- > Chaise avec assise et dossier en bois revêtus en tissu, châssis 4 pieds en frêne ; version avec dossier haut.
- > Stuhl mit gepolsterten Sitzfläche und Rückenlehne aus Esche, Gestell aus 4-beinigem Eschenholz. Ausführung mit hoher Rückenlehne.
- > Silla con estructura 4 patas en madera de fresno. Asiento y respaldo en madera de fresno tapizados. Versión con respaldo alto.

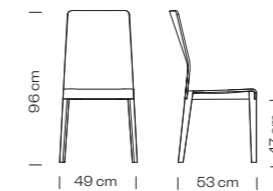

Peso / Weight / Poids / Gewicht / Peso **8,2 kg**

Imballo / Packaging / Emballage / Verpackung / Embalaje **0,28 m³**

Pezzi per scatola / Pieces per box / Pièces par carton / Stücke in einem Karton / Piezas por caja **1**



663

- > Sgabello con seduta e schienale in frassino rivestiti in tessuto, telaio 4 gambe in frassino.
- > 4-leg stool with ash wood frame. Upholstered seat and back.
- > Tabouret avec assise et dossier en bois revêtus en tissu, châssis 4 pieds en frêne.
- > Hocker mit gepolsterten Sitzfläche und Rückenlehne aus Esche, Gestell aus 4-beinigem Eschenholz.
- > Taburete con estructura 4 patas en madera de fresno. Asiento y respaldo en madera de fresno tapizados.

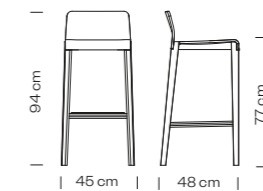

Peso / Weight / Poids / Gewicht / Peso **5,6 kg**

Imballo / Packaging / Emballage / Verpackung / Embalaje **0,28 m³**

Pezzi per scatola / Pieces per box / Pièces par carton / Stücke in einem Karton / Piezas por caja **1**



664

- > Poltrona lounge con seduta e schienale in frassino rivestiti in tessuto, telaio 4 gambe in frassino.
- > 4-leg lounge chair with ash wood frame. Upholstered seat and back.
- > Fauteuil lounge avec assise et dossier en bois revêtus en tissu, châssis 4 pieds en frêne.
- > Lounge-Sessel mit gepolsterten Sitzfläche und Rückenlehne aus Esche, Gestell aus 4-beinigem Eschenholz.
- > Sillón lounge estructura 4 patas en madera de fresno. Asiento y respaldo en madera de fresno tapizados.

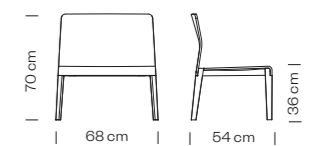

Peso / Weight / Poids / Gewicht / Peso **10,1 kg**

Imballo / Packaging / Emballage / Verpackung / Embalaje **0,39 m³**

Pezzi per scatola / Pieces per box / Pièces par carton / Stücke in einem Karton / Piezas por caja **1**





66



67

TE

- > Finiture seduta
(vedi p. 359)
- > Seat finishes
(see p. 359)
- > Finitions de l'assise
(voir p. 359)
- > Sitzfertigung
(sehen S. 359)
- > Acabados asiento
(ver p. 359)

LE

- > Finiture telaio
- > Frame finishes
- > Finitions piètement
- > Gestell fertigung
- > Acabados estructura

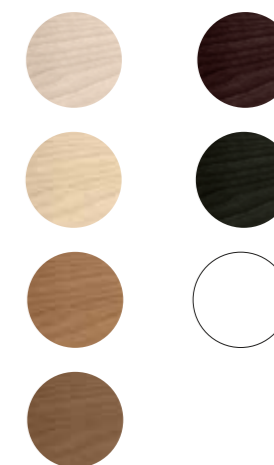

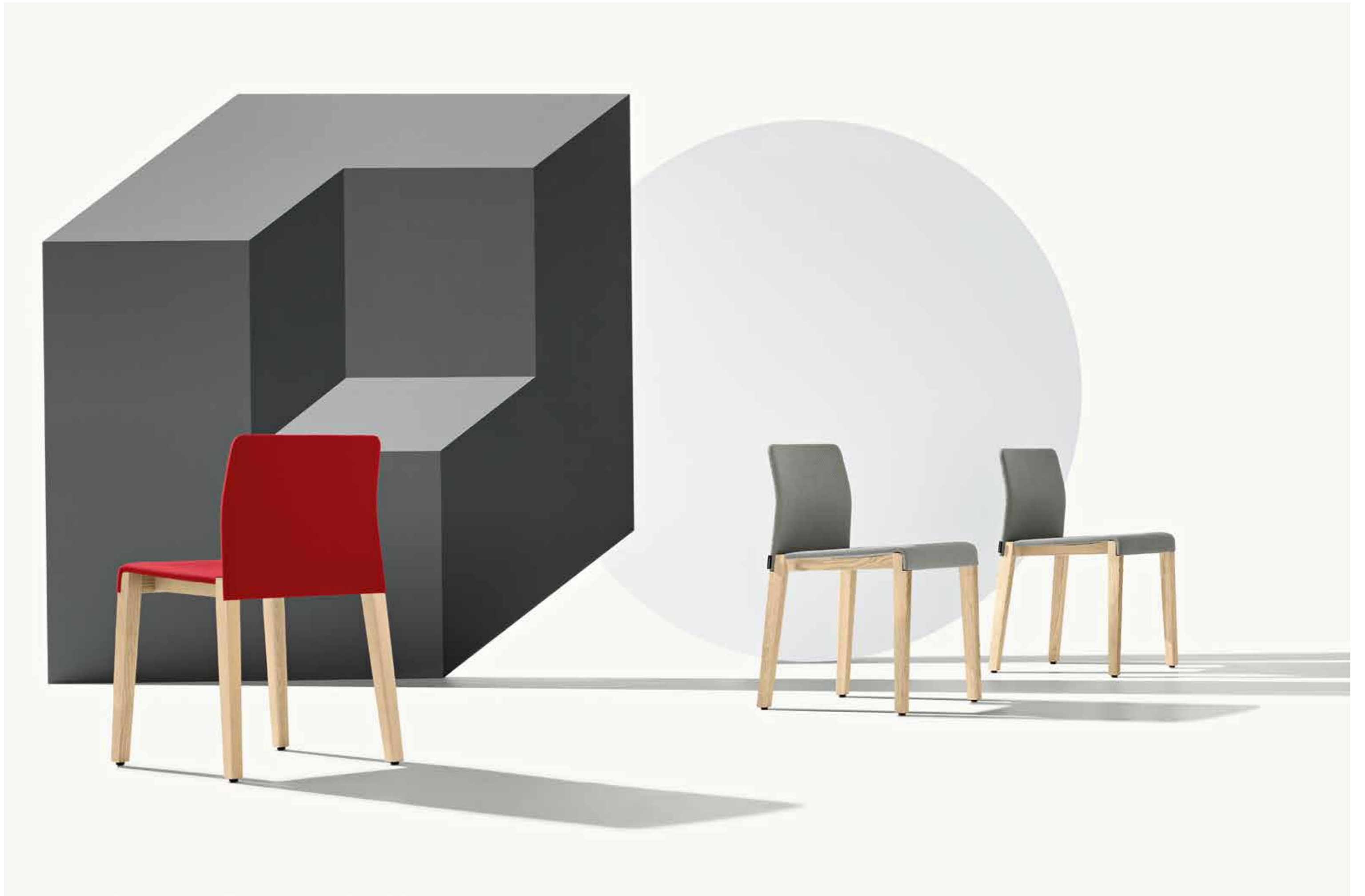



myra

design
Emilio Nanni, 2016



652

- > Sedia con seduta e schienale imbottiti, rivestimento in tessuto, telaio 4 gambe in tubo acciaio.
- > Chair with 4 legs steel frame, upholstered seat and back.
- > Chaise avec assise et dossier rembourrés, revêtement en tissu, châssis 4 pieds en acier.
- > Stuhl mit gepolsterten Sitzfläche und Rückenlehne. Bezug aus Stoff. 4-beinigem Stahlgestell.
- > Silla con estructura tubular 4 patas en acero. Asiento y respaldo tapizados.

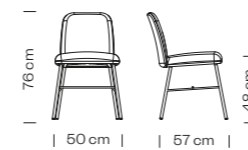

Peso / Weight / Poids / Gewicht / Peso **7,1 kg**

Imballo / Packaging / Emballage / Verpackung / Embalaje **0,33 m³**

Pezzi per scatola / Pieces per box / Pièces par carton / Stücke in einem Karton / Piezas por caja **2**



653

- > Poltroncina con seduta e schienale imbottiti, rivestimento in tessuto, telaio 4 gambe in tubo acciaio.
- > Armchair with 4 legs steel frame, upholstered seat and back.
- > Fauteuil avec assise et dossier rembourrés, revêtement en tissu, châssis 4 pieds en acier.
- > Armlehnstuhl mit gepolsterten Sitzfläche und Rückenlehne. Bezug aus Stoff. 4-beinigem Stahlgestell.
- > Sillón con estructura tubular 4 patas en acero. Asiento y respaldo tapizados.

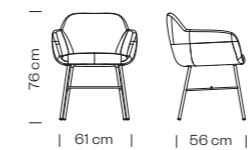

Peso / Weight / Poids / Gewicht / Peso **9 kg**

Imballo / Packaging / Emballage / Verpackung / Embalaje **0,32 m³**

Pezzi per scatola / Pieces per box / Pièces par carton / Stücke in einem Karton / Piezas por caja **1**



654

- > Sgabello con seduta e schienale imbottiti, rivestimento in tessuto, telaio 4 gambe in tubo acciaio.
- > Barstool with 4 legs steel frame, upholstered seat and back.
- > Tabouret avec assise et dossier rembourrés, revêtement en tissu, châssis 4 pieds en acier.
- > Barhocker mit gepolsterten Sitzfläche und Rückenlehne. Bezug aus Stoff. 4-beinigem Stahlgestell.
- > Taburete con estructura tubular 4 patas en acero. Asiento y respaldo tapizados.

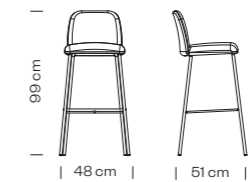

Peso / Weight / Poids / Gewicht / Peso **7,7 kg**

Imballo / Packaging / Emballage / Verpackung / Embalaje **0,28 m³**

Pezzi per scatola / Pieces per box / Pièces par carton / Stücke in einem Karton / Piezas por caja **1**



654B

- > Sgabello con seduta e schienale imbottiti, rivestimento in tessuto, telaio 4 gambe in tubo acciaio. Versione con altezza seduta H 65 cm.
- > Barstool with 4 legs steel frame, upholstered seat and back. Version with seat-height H 65 cm.
- > Tabouret avec assise et dossier rembourrés, revêtement en tissu, châssis 4 pieds en acier. Version avec hauteur assise 65 cm.
- > Barhocker mit gepolsterten Sitzfläche und Rückenlehne. Bezug aus Stoff. 4-beinigem Stahlgestell. Sitzhöhe 65 cm.
- > Taburete con estructura tubular 4 patas en acero. Asiento y respaldo tapizados. Altura asiento 65 cm.

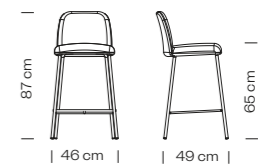

Peso / Weight / Poids / Gewicht / Peso **7,1 kg**

Imballo / Packaging / Emballage / Verpackung / Embalaje **0,24 m³**

Pezzi per scatola / Pieces per box / Pièces par carton / Stücke in einem Karton / Piezas por caja **1**





655

- > Poltrona lounge con seduta e schienale imbottiti, rivestimento in tessuto, telaio 4 gambe in acciaio.
- > Lounge armchair with 4 legs steel frame and upholstered seat and back.
- > Fauteuil lounge avec assise et dossier rembourrés, revêtement en tissu, châssis 4 pieds en acier.
- > Loungesessel mit gepolsterten Sitzfläche und Rückenlehne. Bezug aus Stoff. 4-beinigem Stahlgestell.
- > Sillón lounge con estructura tubular 4 patas en acero. Asiento y respaldo tapizados.



674

- > Sedia con seduta e schienale imbottiti, rivestimento in tessuto, telaio a basamento centrale girevole.
- > Swivel chair with central steel base. Upholstered seat and back.
- > Chaise avec pietement central pivotant en acier, assise et dossier rembourrés, revêtement en tissu.
- > Stuhl mit drehbaren Untergestell und mittlerem Standfuss aus Stahl. Gepolsterte Sitzfläche und Rückenlehne.
- > Silla con asiento y respaldo tapizados, estructura columna central giratoria.



675

- > Poltroncina con seduta e schienale imbottiti, rivestimento in tessuto, telaio a basamento centrale girevole.
- > Swivel armchair with central steel base. Upholstered seat and back.
- > Fauteuil avec pietement central pivotant en acier, assise et dossier rembourrés, revêtement en tissu.
- > Armlehnstuhl mit drehbaren Untergestell und mittlerem Standfuss aus Stahl. Gepolsterte Sitzfläche und Rückenlehne.
- > Sillón con asiento y respaldo tapizados, estructura columna central giratoria.



676

- > Poltrona lounge con seduta e schienale imbottiti, rivestimento in tessuto, telaio a basamento centrale girevole.
- > Swivel lounge armchair with central steel base. Upholstered seat and back.
- > Fauteuil lounge avec pietement central pivotant en acier, assise et dossier rembourrés, revêtement en tissu.
- > Lounge Sessel mit drehbaren Untergestell und mittlerem Standfuss aus Stahl. Gepolsterte Sitzfläche und Rückenlehne.
- > Sillón lounge con asiento y respaldo tapizados, estructura columna central giratoria.

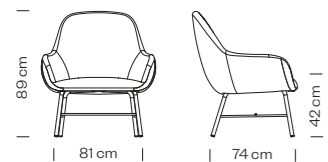

Peso / Weight / Poids / Gewicht / Peso **16 kg**

Imballo / Packaging / Emballage / Verpackung / Embalaje **0,60 m³**

Pezzi per scatola / Pieces per box / Pièces par carton / Stücke in einem Karton / Piezas por caja **1**

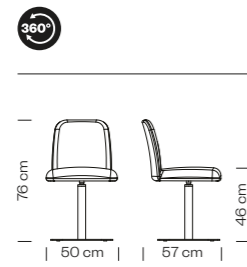

Peso / Weight / Poids / Gewicht / Peso **14,2 kg**

Imballo / Packaging / Emballage / Verpackung / Embalaje **0,32 m³**

Pezzi per scatola / Pieces per box / Pièces par carton / Stücke in einem Karton / Piezas por caja **1**

674-SR
Versione con meccanismo di ritorno / Version with kick-back device / Version avec mechanisme de retour / Ausführung mit automatischer Rucksysteme / Version con sistema de vuelta

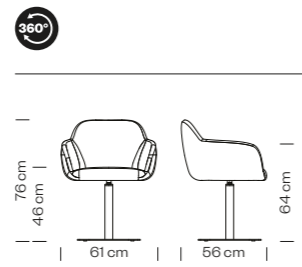

Peso / Weight / Poids / Gewicht / Peso **16,8 kg**

Imballo / Packaging / Emballage / Verpackung / Embalaje **0,32 m³**

Pezzi per scatola / Pieces per box / Pièces par carton / Stücke in einem Karton / Piezas por caja **1**

675-SR
Versione con meccanismo di ritorno / Version with kick-back device / Version avec mechanisme de retour / Ausführung mit automatischer Rucksysteme / Version con sistema de vuelta

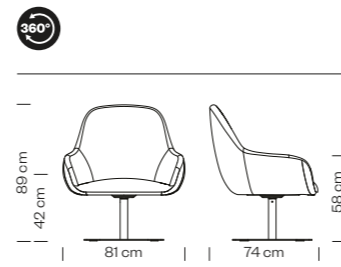

Peso / Weight / Poids / Gewicht / Peso **30,1 kg**

Imballo / Packaging / Emballage / Verpackung / Embalaje **0,60 m³**

Pezzi per scatola / Pieces per box / Pièces par carton / Stücke in einem Karton / Piezas por caja **1**

676-SRB
Versione con meccanismo di ritorno e sistema basculante / Version with kick-back device and tilting system / Version avec mechanisme de retour et systeme basculant / Ausführung mit automatischer Ruck und Kippssysteme / Version con sistema de vuelta y mecanismo de inclinacion

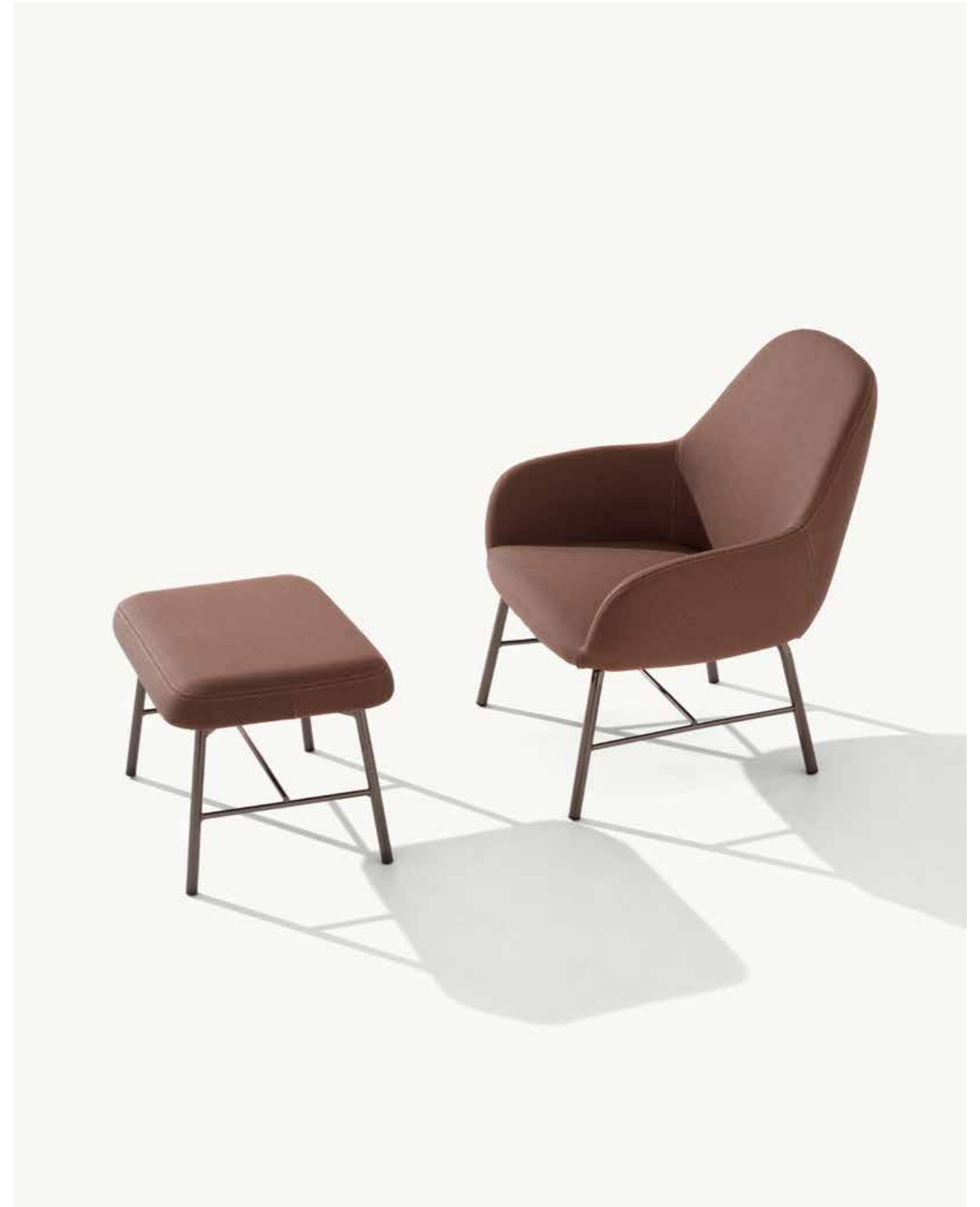





677

- > Poltrona lounge con seduta e schienale imbottiti, rivestimento in tessuto, telaio 4 razze in alluminio, girevole, con meccanismo di ritorno.
- > Swivel lounge chair with 4 legs steel frame and upholstered seat and back, 4 ways aluminium frame. Kick-back device.
- > Fauteuil lounge pivotante avec assise et dossier rembourrés, revêtement en tissu, châssis en aluminium 4 branches. Avec mécanisme de retour.
- > Lounge Sessel mit 4-armigem drehbaren Fusskreuz aus Aluminium. Gepolsterte Sitzfläche und Rückenlehne. Automatischer zurück System.
- > Sillón lounge con asiento y respaldo tapizados, estructura 4 radios en aluminio, giratoria.



678

- > Poltroncina con seduta e schienale imbottiti, rivestimento in tessuto, telaio 4 razze in alluminio, girevole.
- > Swivel armchair with 4 legs steel frame and upholstered seat and back, 4 ways aluminium frame.
- > Chair lounge pivotante avec assise et dossier rembourrés, revêtement en tissu, châssis en aluminium 4 branches.
- > Armlehnstuhl mit 4-armigem drehbaren Fusskreuz aus Aluminium. Gepolsterte Sitzfläche und Rückenlehne.
- > Sillón con asiento y respaldo tapizados, estructura 4 radios en aluminio, giratoria.



679

- > Divano con seduta e schienale imbottiti, rivestimento in tessuto, telaio 4 gambe in tubo acciaio.
- > Sofa with upholstered seat and back, steel frame, 4 legs.
- > Canapé avec assise et dossier rembourrés, revêtement en tissu, châssis 4 pieds en acier.
- > Sofa mit 4-beinigem Stahlgestell. Gepolsterte Sitzfläche und Rückenlehne.
- > Sofá con asiento y respaldo tapizados, estructura tubular 4 patas en acero.



680

- > Divano con seduta e schienale imbottiti, rivestimento in tessuto, telaio 4 gambe in faggio.
- > Sofa with upholstered seat and back, 4 beech wood legs.
- > Canapé avec assise et dossier rembourrés, revêtement en tissu, châssis 4 pieds en hêtre.
- > Sofa mit 4-beinigem Buchenholzgestell. Gepolsterte Sitzfläche und Rückenlehne.
- > Sofá con asiento y respaldo tapizados, estructura 4 patas en madera de haya.



Peso / Weight / Poids / Gewicht / Peso **19,6 kg**

Imballo / Packaging / Emballage / Verpackung / Embalaje **0,60 m³**

Pezzi per scatola / Pieces per box / Pièces par carton / Stücke in einem Karton / Piezas por caja **1**

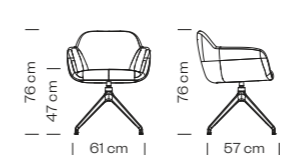

Peso / Weight / Poids / Gewicht / Peso **11,6 kg**

Imballo / Packaging / Emballage / Verpackung / Embalaje **0,32 m³**

Pezzi per scatola / Pieces per box / Pièces par carton / Stücke in einem Karton / Piezas por caja **1**

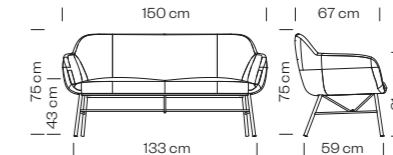

Peso / Weight / Poids / Gewicht / Peso **24,5 kg**

Imballo / Packaging / Emballage / Verpackung / Embalaje **0,80 m³**

Pezzi per scatola / Pieces per box / Pièces par carton / Stücke in einem Karton / Piezas por caja **1**

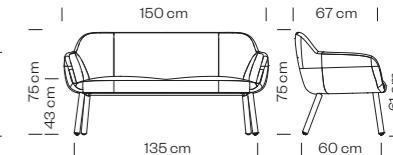

Peso / Weight / Poids / Gewicht / Peso **23 kg**

Imballo / Packaging / Emballage / Verpackung / Embalaje **0,80 m³**

Pezzi per scatola / Pieces per box / Pièces par carton / Stücke in einem Karton / Piezas por caja **1**



660

- > Pouf imbottito con telaio 4 gambe in tubo acciaio.
- > Upholstered pouf with 4 legs steel frame.
- > Pouf rembourrée, avec châssis 4 pieds en acier.
- > Gepolsterter Hocker mit 4-beinigem Stahlgestell.
- > Pouf tapizado con estructura tubular 4 patas en acero.

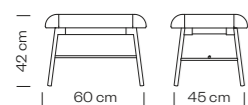

Peso / Weight / Poids / Gewicht / Peso **6,7 kg**

Imballo / Packaging / Emballage / Verpackung / Embalaje **0,16 m³**

Pezzi per scatola / Pieces per box / Pièces par carton / Stücke in einem Karton / Piezas por caja **1**



681

- > Poltrona bergère con seduta e schienale imbottiti, rivestimento in tessuto, telaio 4 gambe in tubo acciaio.
- > Wing chair with upholstered seat and back, steel frame, 4 legs.
- > Fauteuil bergère avec assise et dossier rembourrés, revêtement en tissu, châssis 4 pieds en acier.
- > Bergère Sessel mit 4-beinigem Stahlgestell. Gepolsterte Sitzfläche und Rückenlehne.
- > Sillón bergère con asiento y respaldo tapizados, estructura tubular 4 patas en acero.

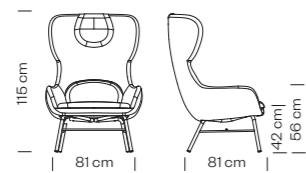

Peso / Weight / Poids / Gewicht / Peso **21,8 kg**

Imballo / Packaging / Emballage / Verpackung / Embalaje **0,75 m³**

Pezzi per scatola / Pieces per box / Pièces par carton / Stücke in einem Karton / Piezas por caja **1**



682

- > Poltrona bergère con seduta e schienale imbottiti, rivestimento in tessuto, telaio 4 gambe in faggio.
- > Wing chair with upholstered seat and back, 4 beech wood legs.
- > Fauteuil bergère avec assise et dossier rembourrés, revêtement en tissu, châssis 4 pieds en hêtre.
- > Bergère Sessel mit 4-beinigem Buchenholzgestell. Gepolsterte Sitzfläche und Rückenlehne.
- > Sillón bergère con asiento y respaldo tapizados, estructura 4 patas en madera de haya.

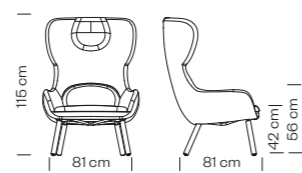

Peso / Weight / Poids / Gewicht / Peso **21,3 kg**

Imballo / Packaging / Emballage / Verpackung / Embalaje **0,75 m³**

Pezzi per scatola / Pieces per box / Pièces par carton / Stücke in einem Karton / Piezas por caja **1**



683

- > Poltrona bergère con seduta e schienale imbottiti, rivestimento in tessuto, telaio 4 razze in alluminio, girevole.
- > Swivel wing chair with upholstered seat and back, 4 ways aluminium frame.
- > Fauteuil bergère pivotante avec assise et dossier rembourrés, revêtement en tissu, châssis en aluminium 4 branches.
- > Bergère Sessel mit 4-armigem drehbaren Fusskreuz aus Aluminium. Gepolsterte Sitzfläche und Rückenlehne.
- > Sillón bergère con asiento y respaldo tapizados, estructura 4 radios en aluminio, giratoria.



Peso / Weight / Poids / Gewicht / Peso **25,2 kg**

Imballo / Packaging / Emballage / Verpackung / Embalaje **0,75 m³**

Pezzi per scatola / Pieces per box / Pièces par carton / Stücke in einem Karton / Piezas por caja **1**







656

- > Sedia con seduta e schienale imbottiti, rivestimento in tessuto, telaio 4 gambe in faggio.
- > Chair with beech wood frame, 4 legs. Upholstered seat and back.
- > Chaise avec assise et dossier rembourrés, revêtement en tissu, châssis 4 pieds en hêtre.
- > Stuhl mit gepolsterten Sitzfläche und Rückenlehne. Bezug aus Stoff. 4-beinigem Buchenholzgestell.
- > Silla con estructura 4 patas en madera de haya. Asiento y respaldo tapizados.



657

- > Poltroncina con seduta e schienale imbottiti, rivestimento in tessuto, telaio 4 gambe in faggio.
- > Armchair with beech wood frame, 4 legs. Upholstered seat and back.
- > Fauteuil avec assise et dossier rembourrés, revêtement en tissu, châssis 4 pieds en hêtre.
- > Armlehnstuhl mit gepolsterten Sitzfläche und Rückenlehne. Bezug aus Stoff. 4-beinigem Buchenholzgestell.
- > Sillón con estructura 4 patas en madera de haya. Asiento y respaldo tapizados.



658

- > Sgabello con seduta e schienale imbottiti, rivestimento in tessuto, telaio 4 gambe in faggio.
- > Barstool with beech wood frame, 4 legs. Upholstered seat and back.
- > Tabouret avec assise et dossier rembourrés, revêtement en tissu, châssis 4 pieds en hêtre.
- > Barhocker mit gepolsterten Sitzfläche und Rückenlehne. Bezug aus Stoff. 4-beinigem Buchenholzgestell.
- > Taburete con estructura 4 patas en madera de haya. Asiento y respaldo tapizados.



658B

- > Sgabello con seduta e schienale imbottiti, rivestimento in tessuto, telaio 4 gambe in faggio. Versione seduta H 65 cm.
- > Barstool with beech wood frame, 4 legs. Upholstered seat and back. Version seat-height H 65 cm.
- > Tabouret avec assise et dossier rembourrés, revêtement en tissu, châssis 4 pieds en hêtre. Version avec hauteur assise 65 cm.
- > Barhocker mit gepolsterten Sitzfläche und Rückenlehne. Bezug aus Stoff. 4-beinigem Buchenholzgestell. Sitzhöhe 65 cm.
- > Taburete con estructura 4 patas en madera de haya. Asiento y respaldo tapizados. Altura asiento 65 cm.



659

- > Poltrona lounge con seduta e schienale imbottiti, rivestimento in tessuto, telaio 4 gambe in faggio.
- > Lounge armchair with beech wood frame, 4 legs. Upholstered seat and back.
- > Fauteuil lounge avec assise et dossier rembourrés, revêtement en tissu, châssis 4 pieds en hêtre.
- > Loungesessel mit gepolsterten Sitzfläche und Rückenlehne. Bezug aus Stoff. 4-beinigem Buchenholzgestell.
- > Sillón lounge con estructura 4 patas en madera de haya. Asiento y respaldo tapizados.

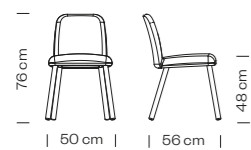

Peso / Weight / Poids / Gewicht / Peso **6,9 kg**

Imballo / Packaging / Emballage / Verpackung / Embalaje **0,33 m³**

Pezzi per scatola / Pieces per box / Pièces par carton / Stücke in einem Karton / Piezas por caja **2**

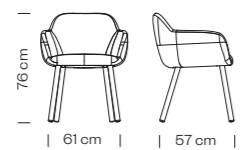

Peso / Weight / Poids / Gewicht / Peso **8,8 kg**

Imballo / Packaging / Emballage / Verpackung / Embalaje **0,32 m³**

Pezzi per scatola / Pieces per box / Pièces par carton / Stücke in einem Karton / Piezas por caja **1**

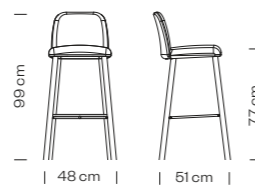

Peso / Weight / Poids / Gewicht / Peso **7,7 kg**

Imballo / Packaging / Emballage / Verpackung / Embalaje **0,28 m³**

Pezzi per scatola / Pieces per box / Pièces par carton / Stücke in einem Karton / Piezas por caja **1**



Peso / Weight / Poids / Gewicht / Peso **7,4 kg**

Imballo / Packaging / Emballage / Verpackung / Embalaje **0,24 m³**

Pezzi per scatola / Pieces per box / Pièces par carton / Stücke in einem Karton / Piezas por caja **1**

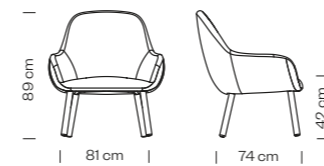

Peso / Weight / Poids / Gewicht / Peso **14,7 kg**

Imballo / Packaging / Emballage / Verpackung / Embalaje **0,60 m³**

Pezzi per scatola / Pieces per box / Pièces par carton / Stücke in einem Karton / Piezas por caja **1**







667

- > Panca 1 posto con seduta imbottita, telaio 4 gambe in tubo acciaio.
- > One seat bench with 4 legs steel frame and upholstered seat.
- > Banquette un place avec assise rembourrée et châssis 4 pieds en acier.
- > Bank mit gepolsterter Sitzfläche, 1 Sitzplatz. 4-beinigem Stahlgestell.
- > Banco asiento singulo tapizado, estructura tubular 4 patas en acero.

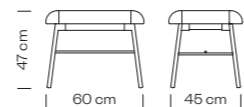

Peso / Weight / Poids / Gewicht / Peso **6,9 kg**

Imballo / Packaging / Emballage / Verpackung / Embalaje **0,16 m³**

Pezzi per scatola / Pieces per box / Pièces par carton / Stücke in einem Karton / Piezas por caja **1**



668

- > Panca 2 posti con seduta imbottita, telaio 4 gambe in tubo acciaio.
- > Two seat bench with 4 legs steel frame and upholstered seat.
- > Banquette deux places avec assise rembourrée et châssis 4 pieds en acier.
- > Bank mit gepolsterter Sitzfläche, 2 Sitzplätze. 4-beinigem Stahlgestell.
- > Banco con asiento doble tapizado, estructura tubular 4 patas en acero.

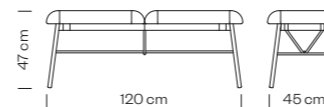

Peso / Weight / Poids / Gewicht / Peso **13 kg**

Imballo / Packaging / Emballage / Verpackung / Embalaje **0,30 m³**

Pezzi per scatola / Pieces per box / Pièces par carton / Stücke in einem Karton / Piezas por caja **1**



669

- > Panca 3 posti con seduta imbottita, telaio 4 gambe in tubo acciaio.
- > Three seat bench with 4 legs steel frame and upholstered seat.
- > Banquette trois places avec assise rembourrée et châssis 4 pieds en acier.
- > Bank mit gepolsterter Sitzfläche, 3 Sitzplätze. 4-beinigem Stahlgestell.
- > Banco con asiento triple tapizado, estructura tubular 4 patas en acero.

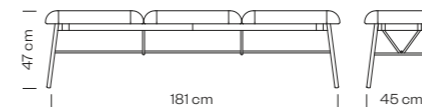

Peso / Weight / Poids / Gewicht / Peso **19 kg**

Imballo / Packaging / Emballage / Verpackung / Embalaje **0,45 m³**

Pezzi per scatola / Pieces per box / Pièces par carton / Stücke in einem Karton / Piezas por caja **1**

TE

- > Finiture seduta (vedi p. 359)
- > Seat finishes (see p. 359)
- > Finitions de l'assise (voir p. 359)
- > Sitzfertigung (sehen S. 359)
- > Acabados asiento (ver p. 359)

AC

- > Finiture telaio (vedi p. 395)
- > Frame finishes (see p. 395)
- > Finitions piètement (voir p. 395)
- > Gestell fertigung (sehen S. 395)
- > Acabados estructura (ver p. 395)

AL PSH

- > Finiture telaio (vedi p. 398)
- > Frame finishes (see p. 398)
- > Finitions piètement (voir p. 398)
- > Gestell fertigung (sehen S. 398)
- > Acabados estructura (ver p. 398)

AL VR

- > Finiture telaio
- > Frame finishes
- > Finitions piètement
- > Gestell fertigung
- > Acabados estructura



LE

- > Finiture telaio
- > Frame finishes
- > Finitions piètement
- > Gestell fertigung
- > Acabados estructura







ring

design
Radice Orlandini
Design Studio, 2016



670

- > Sedia con seduta e schienale in tessuto, telaio 4 gambe in tubo acciaio.
- > Chair with steel frame, 4 legs. Upholstered seat and back.
- > Chaise avec assise et dossier rembourrés, revêtement en tissu, châssis 4 pieds en acier.
- > Stuhl mit gepolsterten Sitzfläche und Rückenlehne, mit 4-beinigem Stahlgestell.
- > Silla con estructura tubular 4 patas en acero. Asiento y respaldo tapizados.

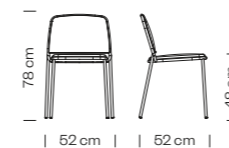

Peso / Weight / Poids / Gewicht / Peso **7,1 kg**

Imballo / Packaging / Emballage / Verpackung / Embalaje **0,39 m³**

Pezzi per scatola / Pieces per box / Pièces par carton / Stücke in einem Karton / Piezas por caja **4**

Impilabile / Stackable / Empilable / Stapelbar / Apilable **4**



671

- > Poltroncina con seduta e schienale in tessuto, telaio 4 gambe in tubo acciaio.
- > Armchair with steel frame, 4 legs. Upholstered seat and back.
- > Fauteuil avec assise et dossier rembourrés, revêtement en tissu, châssis 4 pieds en acier.
- > Armlehnstuhl mit gepolsterten Sitzfläche und Rückenlehne, mit 4-beinigem Stahlgestell.
- > Sillón con estructura tubular 4 patas en acero. Asiento y respaldo tapizados.



Peso / Weight / Poids / Gewicht / Peso **7,5 kg**

Imballo / Packaging / Emballage / Verpackung / Embalaje **0,39 m³**

Pezzi per scatola / Pieces per box / Pièces par carton / Stücke in einem Karton / Piezas por caja **4**

Impilabile / Stackable / Empilable / Stapelbar / Apilable **4**



672

- > Sgabello con seduta e schienale in tessuto, telaio 4 gambe in tubo acciaio.
- > Barstool with steel frame, 4 legs. Upholstered seat and back.
- > Tabouret avec assise et dossier rembourrés, revêtement en tissu, châssis 4 pieds en acier.
- > Barhocker mit gepolsterten Sitzfläche und Rückenlehne, mit 4-beinigem Stahlgestell.
- > Taburete con estructura tubular 4 patas en acero. Asiento y respaldo tapizados.

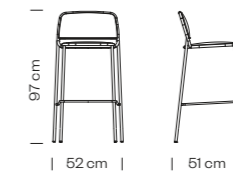

Peso / Weight / Poids / Gewicht / Peso **7,4 kg**

Imballo / Packaging / Emballage / Verpackung / Embalaje **0,40 m³**

Pezzi per scatola / Pieces per box / Pièces par carton / Stücke in einem Karton / Piezas por caja **2**

Impilabile / Stackable / Empilable / Stapelbar / Apilable **4**

TE

- > Finiture seduta (vedi p. 359)
- > Seat finishes (see p. 359)
- > Finitions de l'assise (voir p. 359)
- > Sitzfertigung (sehen S. 359)
- > Acabados asiento (ver p. 359)

AC

- > Finiture telaio (vedi p. 395)
- > Frame finishes (see p. 395)
- > Finitions piètement (voir p. 395)
- > Gestell fertigung (sehen S. 395)
- > Acabados estructura (ver p. 395)



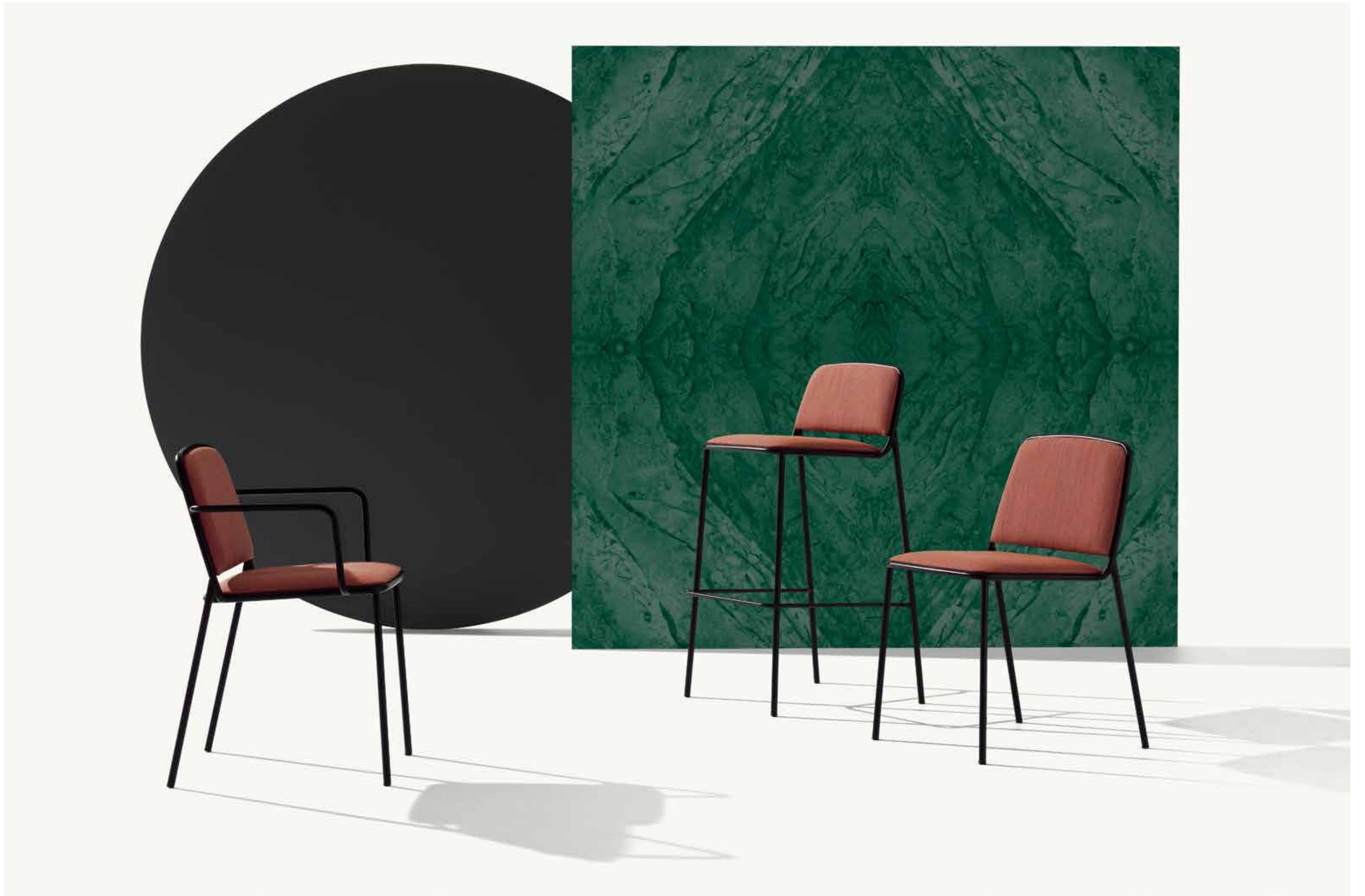



nomad

design
rdm, 2016



106



821

- > Divano 2 posti con seduta e schienale imbottiti, rivestimento in tessuto, piedi in tubo acciaio. Versione senza fianchi.
- > 2 seats sofa with upholstered seat and back. Steel feet, without end sides.
- > Canapé 2 places avec assise et dossier rembourrés, revêtement en tissu, pieds en acier. Version sans accoudoirs.
- > 2-Sitzer-Sofa mit gepolsterten Sitzfläche und Rückenlehne. Bezug aus Stoff. Gestell aus Stahlrohren. Ausführung ohne Armstützen.
- > Sofa 2 asientos con asiento y respaldo tapizados. Pies en acero. Versión sin lados.

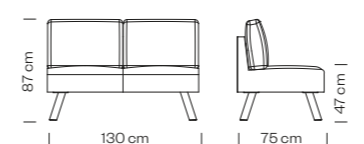

Peso / Weight / Poids / Gewicht / Peso **27,2 kg**

Imballo / Packaging / Emballage / Verpackung / Embalaje **0,61 m³**

Pezzi per scatola / Pieces per box / Pièces par carton / Stücke in einem Karton / Piezas por caja **1**



822

- > Divano 2 posti con seduta e schienale imbottiti, rivestimento in tessuto, piedi in tubo acciaio. Versione con fianchi.
- > 2 seats sofa with upholstered seat and back. Steel feet, with end sides.
- > Canapé 2 places avec assise et dossier rembourrés, revêtement en tissu, pieds en acier. Version avec accoudoirs.
- > 2-Sitzer-Sofa mit gepolsterten Sitzfläche und Rückenlehne. Bezug aus Stoff. Gestell aus Stahlrohren. Ausführung mit Armstützen.
- > Sofa 2 asientos con asiento y respaldo tapizados. Pies en acero. Versión con lados.

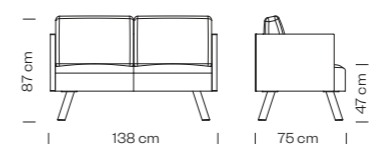

Peso / Weight / Poids / Gewicht / Peso **32,5 kg**

Imballo / Packaging / Emballage / Verpackung / Embalaje **0,61 m³**

Pezzi per scatola / Pieces per box / Pièces par carton / Stücke in einem Karton / Piezas por caja **1**



825

- > Divano 2 posti con seduta e schienale imbottiti, rivestimento in tessuto, piedi in faggio. Versione senza fianchi.
- > 2 seats sofa with upholstered seat and back. Beech wood feet, without end sides.
- > Canapé 2 places avec assise et dossier rembourrés, revêtement en tissu, pieds en hêtre. Version sans accoudoirs.
- > 2-Sitzer-Sofa mit gepolsterten Sitzfläche und Rückenlehne. Bezug aus Stoff. Gestell aus Buchenholzrohren. Ausführung ohne Armstützen.
- > Sofa 2 asientos con asiento y respaldo tapizados. Pies en madera de haya. Versión sin lados.

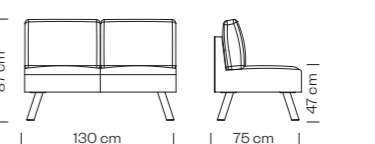

Peso / Weight / Poids / Gewicht / Peso **28 kg**

Imballo / Packaging / Emballage / Verpackung / Embalaje **0,61 m³**

Pezzi per scatola / Pieces per box / Pièces par carton / Stücke in einem Karton / Piezas por caja **1**



826

- > Divano 2 posti con seduta e schienale imbottiti, rivestimento in tessuto, piedi in faggio. Versione con fianchi.
- > 2 seats sofa with upholstered seat and back. Beech wood feet, with end sides.
- > Canapé 2 places avec assise et dossier rembourrés, revêtement en tissu, pieds en hêtre. Version avec accoudoirs.
- > 2-Sitzer-Sofa mit gepolsterten Sitzfläche und Rückenlehne. Bezug aus Stoff. Gestell aus Buchenholzrohren. Ausführung mit Armstützen.
- > Sofa 2 asientos con asiento y respaldo tapizados. Pies en madera de haya. Versión con lados.

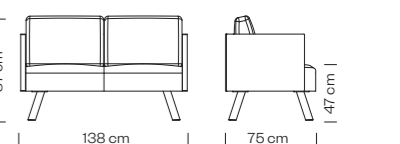

Peso / Weight / Poids / Gewicht / Peso **33,3 kg**

Imballo / Packaging / Emballage / Verpackung / Embalaje **0,61 m³**

Pezzi per scatola / Pieces per box / Pièces par carton / Stücke in einem Karton / Piezas por caja **1**

107



823

- > Divano 3 posti con seduta e schienale imbottiti, rivestimento in tessuto, piedi in tubo acciaio. Versione senza fianchi.
- > 3 seats sofa with upholstered seat and back. Steel feet, without end sides.
- > Canapé 3 places avec assise et dossier rembourrés, revêtement

- en tissu, pieds en acier. Version sans accoudoirs.
- > 3-Sitzer-Sofa mit gepolsterten Sitzfläche und Rückenlehne. Bezug aus Stoff. Gestell aus Stahlrohren. Ausführung ohne Armstützen.
- > Sofa 3 asientos con asiento y respaldo tapizados. Pies en acero. Versión sin lados.

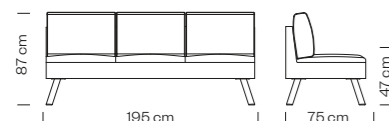

Peso / Weight / Poids / Gewicht / Peso **39,1 kg**

Imballo / Packaging / Emballage / Verpackung / Embalaje **0,88 m³**

Pezzi per scatola / Pieces per box / Pièces par carton / Stücke in einem Karton / Piezas por caja **1**



827

- > Divano 3 posti con seduta e schienale imbottiti, rivestimento in tessuto, piedi in faggio. Versione senza fianchi.
- > 3 seats sofa with upholstered seat and back. Beech wood feet, without end sides.
- > Canapé 3 places avec assise et dossier rembourrés, revêtement en tissu, pieds en hêtre. Version sans accoudoirs.

- > 3-Sitzer-Sofa mit gepolsterten Sitzfläche und Rückenlehne. Bezug aus Stoff. Gestell aus Buchenholzrohren. Ausführung ohne Armstützen.
- > Sofa 3 asientos con asiento y respaldo tapizados. Pies en madera de haya. Versión sin lados.

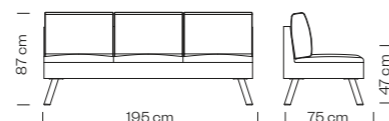

Peso / Weight / Poids / Gewicht / Peso **39,9 kg**

Imballo / Packaging / Emballage / Verpackung / Embalaje **0,88 m³**

Pezzi per scatola / Pieces per box / Pièces par carton / Stücke in einem Karton / Piezas por caja **1**



824

- > Divano 3 posti con seduta e schienale imbottiti, rivestimento in tessuto, piedi in tubo acciaio. Versione con fianchi.
- > 3 seats sofa with upholstered seat and back. Steel feet, with end sides.
- > Canapé 3 places avec assise et dossier rembourrés, revêtement en tissu, pieds en acier. Version

- avec accoudoirs.
- > 3-Sitzer-Sofa mit gepolsterten Sitzfläche und Rückenlehne. Bezug aus Stoff. Gestell aus Stahlrohren. Ausführung mit Armstützen.
- > Sofa 3 asientos con asiento y respaldo tapizados. Pies en acero. Versión con lados.

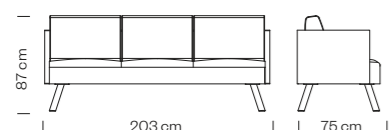

Peso / Weight / Poids / Gewicht / Peso **45,6 kg**

Imballo / Packaging / Emballage / Verpackung / Embalaje **0,88 m³**

Pezzi per scatola / Pieces per box / Pièces par carton / Stücke in einem Karton / Piezas por caja **1**



828

- > Divano 3 posti con seduta e schienale imbottiti, rivestimento in tessuto, piedi in faggio. Versione con fianchi.
- > 3 seats sofa with upholstered seat and back. Beech wood feet, with end sides.
- > Canapé 3 places avec assise et dossier rembourrés, revêtement en tissu, pieds en hêtre. Version avec accoudoirs.

- > 3-Sitzer-Sofa mit gepolsterten Sitzfläche und Rückenlehne. Bezug aus Stoff. Gestell aus Buchenholzrohren. Ausführung mit Armstützen.
- > Sofa 3 asientos con asiento y respaldo tapizados. Pies en madera de haya. Versión con lados.

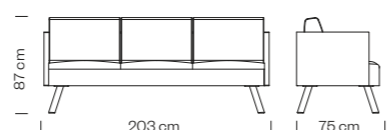

Peso / Weight / Poids / Gewicht / Peso **46,4 kg**

Imballo / Packaging / Emballage / Verpackung / Embalaje **0,88 m³**

Pezzi per scatola / Pieces per box / Pièces par carton / Stücke in einem Karton / Piezas por caja **1**

TE

- > Finiture seduta (vedi p. 359)
- > Seat finishes (see p. 359)
- > Finitions de l'assise (voir p. 359)
- > Sitzfertigung (sehen S. 359)
- > Acabados asiento (ver p. 359)

LE

- > Finiture telaio
- > Frame finishes
- > Finitions piètement
- > Gestell fertigungen
- > Acabados estructura

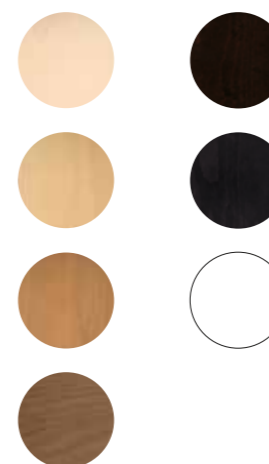

AC

- > Finiture telaio (vedi p. 395)
- > Frame finishes (see p. 395)
- > Finitions piètement (voir p. 395)
- > Gestell fertigungen (sehen S. 395)
- > Acabados estructura (ver p. 395)



flint

design
Marc Sadler, 2015



535-A

- > Poltroncina con telaio a 4 gambe in tubo acciaio, seduta in poliammide, legno di Iroko o cuoio e schienale in tondino acciaio.
- > Armchair with 4 legs steel frame and backrest, polyamide, Iroko wood or leather seat.
- > Fauteuil avec châssis 4 pieds en acier, assise en polyamide, bois Iroko ou cuir, dossier en fil d'acier.
- > Armlehnstuhl mit 4-beinigem Stahlgestell. Sitzfläche aus Polyamid, Iroko oder Leder und Rückenlehne aus Stahlstangen.
- > Sillón con estructura tubular 4 patas en acero. Asiento en poliamida, madera de iroko o cuero y respaldo en acero.



535-B

- > Sedia con telaio a 4 gambe in tubo acciaio, seduta in poliammide o legno di Iroko e schienale in tondino acciaio.
- > Chair with 4 legs steel frame and backrest, polyamide or Iroko wood seat.
- > Chaise avec châssis 4 pieds en acier, assise en polyamide ou bois Iroko, dossier en fil d'acier.
- > Stuhl mit 4-beinigem Stahlgestell. Sitzfläche aus Polyamid oder Iroko und Rückenlehne aus Stahlstangen.
- > Silla con estructura tubular 4 patas en acero. Asiento en poliamida o madera de iroko y respaldo en acero.

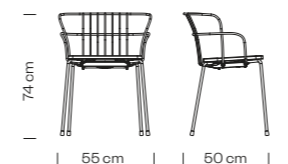

Peso / Weight / Poids / Gewicht / Peso **6,5 kg**

Imballo / Packaging / Emballage / Verpackung / Embalaje **0,39 m³**

Pezzi per scatola / Pieces per box / Pièces par carton / Stücke in einem Karton / Piezas por caja **4**

Impilabile / Stackable / Empilable / Stapelbar / Apilable **4**



Peso / Weight / Poids / Gewicht / Peso **5,3 kg**

Imballo / Packaging / Emballage / Verpackung / Embalaje **0,39 m³**

Pezzi per scatola / Pieces per box / Pièces par carton / Stücke in einem Karton / Piezas por caja **4**

Impilabile / Stackable / Empilable / Stapelbar / Apilable **4**

PA

- > Finiture seduta
- > Seat finishes
- > Finitions de l'assise
- > Sitzfertigung
- > Acabados asiento

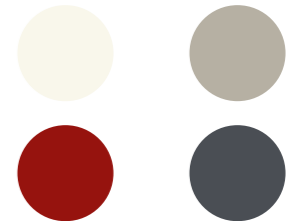

LE

- > Finiture seduta
- > Seat finishes
- > Finitions de l'assise
- > Sitzfertigung
- > Acabados asiento



CU

- > Finiture seduta
- > Seat finishes
- > Finitions de l'assise
- > Sitzfertigung
- > Acabados asiento

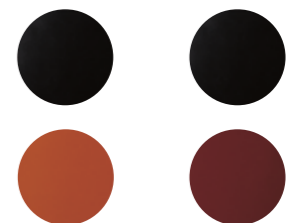



AC

- > Finiture telaio (vedi p. 395)
- > Frame finishes (see p. 395)
- > Finitions piètement (voir p. 395)
- > Gestell fertigungen (sehen S. 395)
- > Acabados estructura (ver p. 395)



stripes

design
Talocci Design, 2015



547

- > Sedia con telaio a 4 gambe in acciaio, seduta e schienale in lamiera. Trattamento in cataforesi.
- > Chair with steel frame, 4 legs. Seat and back in moulded steel. Cataphoresis treatment.
- > Chaise avec châssis 4 pieds en acier avec traitement en cataphorèse, assise et dossier en tôle.
- > Stuhl mit 4-beinigem Stahlgestell, Sitzfläche und Rückenlehne in gepressten Stahl. Mit Kataphorese.
- > Silla con estructura 4 patas en acero, asiento y respaldo en plancha de acero. Con tratamiento de cataforesis.

548

- > Sedia con braccioli e telaio a 4 gambe in acciaio, seduta e schienale in lamiera. Trattamento in cataforesi.
- > Chair with armrests in steel frame, 4 legs. Seat and back in moulded steel. Cataphoresis treatment.
- > Chaise avec châssis 4 pieds en acier avec traitement en cataphorèse, assise et dossier en tôle. Avec accoudoirs.
- > Armlehnstuhl mit 4-beinigem Stahlgestell, Sitzfläche und Rückenlehne in gepressten Stahl. Mit Kataphorese.
- > Silla con estructura 4 patas en acero con brazos, asiento y respaldo en plancha de acero. Con tratamiento de cataforesis.

AC

- > Finiture seduta (vedi p. 358)
- > Seat finishes (see p. 358)
- > Finitions de l'assise (voir p. 358)
- > Sitzfertigung (sehen S. 358)
- > Acabados asiento (ver p. 358)

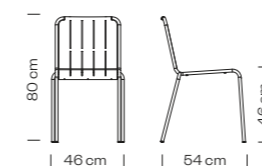

Peso / Weight / Poids / Gewicht / Peso **6 kg**

Imballo / Packaging / Emballage / Verpackung / Embalaje **0,37 m³**

Pezzi per scatola / Pieces per box / Pièces par carton / Stücke in einem Karton / Piezas por caja **4**

Impilabile / Stackable / Empilable / Stapelbar / Apilable **4**

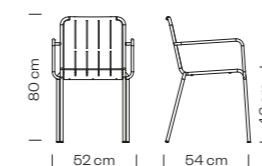

Peso / Weight / Poids / Gewicht / Peso **6,8 kg**

Imballo / Packaging / Emballage / Verpackung / Embalaje **0,37 m³**

Pezzi per scatola / Pieces per box / Pièces par carton / Stücke in einem Karton / Piezas por caja **4**

Impilabile / Stackable / Empilable / Stapelbar / Apilable **4**







play

design
Radice Orlandini
Design Studio, 2015



538

- > Poltroncina con telaio a 4 gambe in tubo acciaio, seduta e schienale imbottiti, rivestimento in tessuto.
- > Armchair with steel frame, 4 legs. Upholstered seat and back.
- > Fauteuil avec assise et dossier rembourrés, revêtement en tissu, châssis 4 pieds en acier.
- > Armlehnstuhl mit 4-beinigem Stahlgestell. Gepolsterte Sitzfläche und Rückenlehne. Bezug aus Stoff.
- > Sillón con estructura tubular 4 patas en acero. Asiento y respaldo tapizados.

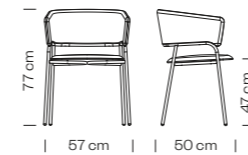

Peso / Weight / Poids / Gewicht / Peso **7,7 kg**

Imballo / Packaging / Emballage / Verpackung / Embalaje **0,26 m³**

Pezzi per scatola / Pieces per box / Pièces par carton / Stücke in einem Karton / Piezas por caja **1**

TE

- > Finiture seduta (vedi p. 359)
- > Seat finishes (see p. 359)
- > Finitions de l'assise (voir p. 359)
- > Sitzfertigung (sehen S. 359)
- > Acabados asiento (ver p. 359)

AC

- > Finiture telaio (vedi p. 395)
- > Frame finishes (see p. 395)
- > Finitions piètement (voir p. 395)
- > Gestell fertigung (sehen S. 395)
- > Acabados estructura (ver p. 395)



bikini

design
Marc Sadler, 2015



124



530

- > Sedia con seduta in polipropilene, telaio 4 gambe in tubo acciaio.
- > Chair with 4 legs steel frame and polypropylene shell.
- > Chaise avec coque en polypropylène, châssis en acier 4 pieds.
- > Stuhl mit Schale aus Polypropylen und 4-beinigem Stahlgestell.
- > Silla con estructura tubular 4 patas en acero, carcasa en polipropileno.

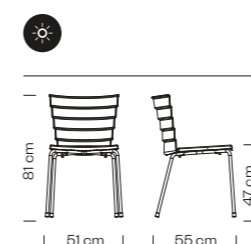

Peso / Weight / Poids / Gewicht / Peso **5,2 kg**

Imballo / Packaging / Emballage / Verpackung / Embalaje **0,39 m³**

Pezzi per scatola / Pieces per box / Pièces par carton / Stücke in einem Karton / Piezas por caja **4**

Impilabile / Stackable / Empilable / Stapelbar / Apilable **4**



531

- > Sedia con seduta in polipropilene, telaio a slitta in tondino acciaio.
- > Chair with sled steel frame and polypropylene shell.
- > Chaise avec coque en polypropylène, châssis en fil d'acier pied luge.
- > Stuhl mit Schale aus Polypropylen und Kufengestell aus Stahl.
- > Silla con estructura patin en acero, carcasa en polipropileno.

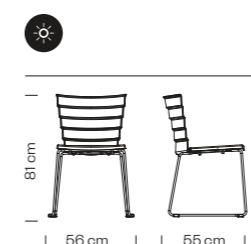

Peso / Weight / Poids / Gewicht / Peso **6,4 kg**

Imballo / Packaging / Emballage / Verpackung / Embalaje **0,39 m³**

Pezzi per scatola / Pieces per box / Pièces par carton / Stücke in einem Karton / Piezas por caja **4**

Impilabile / Stackable / Empilable / Stapelbar / Apilable **4**

125

PP

- > Finiture seduta
- > Seat finishes
- > Finitions de l'assise
- > Sitzfertiger
- > Acabados asiento

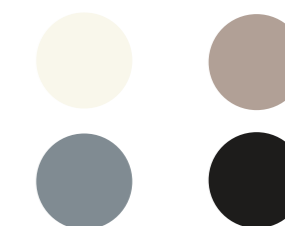

AC

- > Finiture telaio (vedi p. 395)
- > Frame finishes (see p. 395)
- > Finitions piètement (voir p. 395)
- > Gestell fertigkeiten (sehen S. 395)
- > Acabados estructura (ver p. 395)





to-kyo

design
Makio Hasuike & Co., 2014



130



540

- > Sedia con telaio a 4 gambe in faggio. Sedile e schienale in tessuto.
- > Chair with beech wood frame, 4 legs. Upholstered seat and back.
- > Chaise avec châssis 4 pieds en hêtre. Assise et dossier en tissu.
- > Stuhl mit 4-beinigem Buchenholzgestell. Gepolsterte Sitzfläche und Rückenlehne.
- > Silla con estructura 4 patas en madera de haya. Asiento y respaldo tapizados.

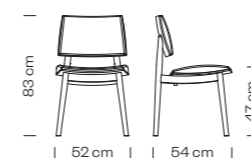

Peso / Weight / Poids / Gewicht / Peso **6 kg**

Imballo / Packaging / Emballage / Verpackung / Embalaje **0,29 m³**

Pezzi per scatola / Pieces per box / Pièces par carton / Stücke in einem Karton / Piezas por caja **1**



541

- > Poltrona lounge con telaio a 4 gambe in faggio. Sedile e schienale in tessuto.
- > Lounge chair with beech wood frame, 4 legs. Upholstered seat and back.
- > Chaise lounge avec châssis 4 pieds en hêtre. Assise et dossier en tissu.
- > Lounge-Sofa mit 4-beinigem Buchenholzgestell. Gepolsterte Sitzfläche und Rückenlehne.
- > Sillón lounge con estructura 4 patas en madera de haya. Asiento y respaldo tapizados.

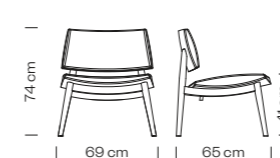

Peso / Weight / Poids / Gewicht / Peso **9 kg**

Imballo / Packaging / Emballage / Verpackung / Embalaje **0,50 m³**

Pezzi per scatola / Pieces per box / Pièces par carton / Stücke in einem Karton / Piezas por caja **1**

TE

- > Finiture seduta (vedi p. 359)
- > Seat finishes (see p. 359)
- > Finitions de l'assise (voir p. 359)
- > Sitzfertigung (sehen S. 359)
- > Acabados asiento (ver p. 359)

LE

- > Finiture telaio
- > Frame finishes
- > Finitions piètement
- > Gestell fertigungen
- > Acabados estructura



131





134



135





maré

design
Marc Sadler, 2014



539

- > Poltroncina con telaio a 4 gambe in tubo alluminio anodizzato o verniciato. Seduta in polipropilene.
- > Armchair with anodized or powder coated aluminium frame, 4 legs. Polypropylene seat and back.
- > Fauteuil avec chassis 4 pieds en aluminium anodisé ou verni. Coque en polypropylène.
- > Armlehnstuhl mit 4-beinigem Aluminiumgestell in eloxierter oder lackierter Ausführung. Sitzfläche aus Polypropylen.
- > Sillón con estructura 4 patas en aluminio anodizado o barnizado. Carcasa en polipropileno.

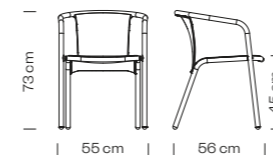

Peso / Weight / Poids / Gewicht / Peso **4,5 kg**

Imballo / Packaging / Emballage / Verpackung / Embalaje **0,47 m³**

Pezzi per scatola / Pieces per box / Pièces par carton / Stücke in einem Karton / Piezas por caja **4**

Impilabile / Stackable / Empilable / Stapelbar / Apilable **4**

TE

- > Finiture seduta (vedi p. 359)
- > Seat finishes (see p. 359)
- > Finitions de l'assise (voir p. 359)
- > Sitzfertigung (sehen S. 359)
- > Acabados asiento (ver p. 359)

PP

- > Finiture seduta
- > Seat finishes
- > Finitions de l'assise
- > Sitzfertigung
- > Acabados asiento

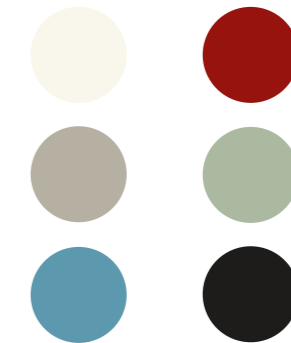

AL VR

- > Finiture telaio
- > Frame finishes
- > Finitions piètement
- > Gestell fertigung
- > Acabados estructura



AL AND

- > Finiture telaio
- > Frame finishes
- > Finitions piètement
- > Gestell fertigung
- > Acabados estructura







142



143



uni-ka

design
rdm, 2014





594

- > Poltroncina con telaio 4 gambe in acciaio, seduta in polipropilene.
- > Armchair with steel frame, 4 legs. Polypropylene shell.
- > Fauteuil avec châssis en acier 4 pieds et coque en polypropylène.
- > Armlehnstuhl mit 4-beinigem Stahlgestell. Sitzfläche aus Polypropylen.
- > Sillón con estructura tubular 4 patas en acero, carcasa en polipropileno.



594M

- > Poltroncina con seduta in polipropilene, imbottita. Telaio 4 gambe in tubo acciaio.
- > Armchair with steel frame, 4 legs. Upholstered polypropylene shell.
- > Fauteuil avec châssis en acier 4 pieds et coque en polypropylène rembourrée.
- > Armlehnstuhl mit Sitzfläche aus Polypropylen und Bezug auf Stoff. 4-beiniger Stahlgestell.
- > Sillón con estructura tubular 4 patas en acero, carcasa en polipropileno tapizada.



596

- > Poltroncina con telaio a traliccio in tondino acciaio. Seduta in polipropilene.
- > Armchair with wire steel frame. Polypropylene shell.
- > Fauteuil avec châssis treillis en fil d'acier. Coque en polypropylène.
- > Armlehnstuhl mit Gittergestell aus Stahlstangen. Sitzfläche aus Polypropylen.
- > Sillón con estructura enrejado en acero, carcasa en polipropileno.



596M

- > Poltroncina con seduta in polipropilene, imbottita. Telaio a traliccio in tondino acciaio.
- > Armchair with wire steel frame. Upholstered polypropylene shell.
- > Fauteuil avec châssis treillis en fil d'acier. Coque en polypropylène rembourrée.
- > Armlehnstuhl mit Sitzfläche aus Polypropylen und Bezug aus Stoff. Gittergestell aus Stahlstangen.
- > Sillón con estructura enrejado en acero, carcasa en polipropileno tapizada.



599

- > Poltroncina con telaio 4 gambe in faggio, seduta in polipropilene.
- > Armchair with beech wood frame, 4 legs. Polypropylene shell.
- > Fauteuil avec châssis 4 pieds en hêtre. Coque en polypropylène.
- > Armlehnstuhl mit 4-beinigem Buchenholzgestell. Sitzfläche aus Polypropylen.
- > Sillón con estructura 4 patas en madera de haya. Carcasa en polipropileno.



599M

- > Poltroncina con seduta in polipropilene, imbottita. Telaio 4 gambe in faggio.
- > Armchair with beech wood frame, 4 legs. Upholstered polypropylene shell.
- > Fauteuil avec châssis 4 pieds en hêtre. Coque en polypropylène rembourrée.
- > Armlehnstuhl mit Sitzfläche aus Polypropylen und Bezug aus Stoff. 4-beiniger Buchenholzgestell.
- > Sillón con estructura 4 patas en madera de haya. Carcasa en polipropileno tapizada.



601

- > Poltroncina con telaio 4 gambe in faggio, seduta in polipropilene.
- > Armchair with beech wood frame, 4 legs. Polypropylene shell.
- > Fauteuil avec châssis 4 pieds ronds en hêtre. Coque en polypropylène.
- > Armlehnstuhl mit 4-beinigem Buchenholzgestell. Sitzfläche aus Polypropylen.
- > Sillón con estructura 4 patas redonda en madera de haya. Carcasa en polipropileno.



601M

- > Poltroncina con seduta in polipropilene, imbottita. Telaio 4 gambe in faggio.
- > Armchair with beech wood frame, 4 legs. Upholstered polypropylene shell.
- > Fauteuil avec châssis 4 pieds ronds en hêtre. Coque en polypropylène rembourrée.
- > Armlehnstuhl mit 4-beinigem Buchenholzgestell. Sitzfläche aus Polypropylen und Bezug aus Stoff.
- > Sillón con estructura 4 patas redonda en madera de haya. Carcasa en polipropileno tapizada.

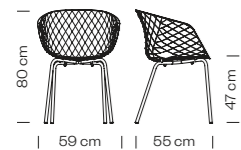

Peso / Weight / Poids / Gewicht / Peso **6,4 kg**

Imballo / Packaging / Emballage / Verpackung / Embalaje **0,42 m³**

Pezzi per scatola / Pieces per box / Pièces par carton / Stücke in einem Karton / Piezas por caja **4**

Impilabile / Stackable / Empilable / Stapelbar / Apilable **4**



Peso / Weight / Poids / Gewicht / Peso **6,9 kg**

Imballo / Packaging / Emballage / Verpackung / Embalaje **0,34 m³**

Pezzi per scatola / Pieces per box / Pièces par carton / Stücke in einem Karton / Piezas por caja **1**



Peso / Weight / Poids / Gewicht / Peso **9,8 kg**

Imballo / Packaging / Emballage / Verpackung / Embalaje **0,34 m³**

Pezzi per scatola / Pieces per box / Pièces par carton / Stücke in einem Karton / Piezas por caja **1**

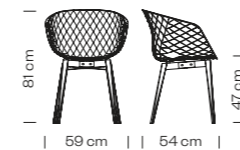

Peso / Weight / Poids / Gewicht / Peso **6,5 kg**

Imballo / Packaging / Emballage / Verpackung / Embalaje **0,34 m³**

Pezzi per scatola / Pieces per box / Pièces par carton / Stücke in einem Karton / Piezas por caja **1**



Peso / Weight / Poids / Gewicht / Peso **9,4 kg**

Imballo / Packaging / Emballage / Verpackung / Embalaje **0,34 m³**

Pezzi per scatola / Pieces per box / Pièces par carton / Stücke in einem Karton / Piezas por caja **1**

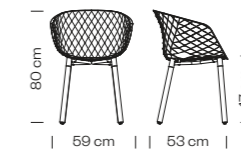

Peso / Weight / Poids / Gewicht / Peso **6,8 kg**

Imballo / Packaging / Emballage / Verpackung / Embalaje **0,34 m³**

Pezzi per scatola / Pieces per box / Pièces par carton / Stücke in einem Karton / Piezas por caja **1**



Peso / Weight / Poids / Gewicht / Peso **9,7 kg**

Imballo / Packaging / Emballage / Verpackung / Embalaje **0,34 m³**

Pezzi per scatola / Pieces per box / Pièces par carton / Stücke in einem Karton / Piezas por caja **1**







595

- > Poltroncina con telaio a slitta in tondino acciaio. Seduta in polipropilene.
- > Armchair with sled steel frame and polypropylene shell.
- > Fauteuil avec châssis pied luge en fil d'acier. Coque en polypropylène.
- > Armlehnstuhl mit Kufengestell aus Stahlstangen. Sitzfläche aus Polypropylen.
- > Sillón con estructura patín en acero, carcasa en polipropileno.



595M

- > Poltroncina con seduta in polipropilene, imbottita. Telaio a slitta in tondino acciaio.
- > Armchair with sled steel frame. Upholstered polypropylene shell.
- > Fauteuil avec châssis pied luge en fil d'acier. Coque en polypropylène rembourrée.
- > Armlehnstuhl mit Sitzfläche aus Polypropylen und Bezug aus Stoff. Kufengestell aus Stahlstangen.
- > Sillón con estructura patín en acero, carcasa en polipropileno tapizada.



598

- > Poltroncina con telaio a basamento centrale girevole in acciaio, con meccanismo di ritorno. Seduta in polipropilene.
- > Swivel armchair with central steel base, kick back device and polypropylene shell.
- > Fauteuil avec pietement central pivotant en acier avec mecanisme de retour. Coque en polypropylène.
- > Armlehnstuhl mit Untergestell und mittlerem Standfuss aus Stahl mit Ruedckdrehaematik. Sitzfläche aus Polypropylen.
- > Sillón con estructura columna central en acero, con sistema de vuelta. Carcasa en polipropileno.



598M

- > Poltroncina con seduta in polipropilene, imbottita. Telaio a basamento centrale in acciaio, girevole con meccanismo di ritorno.
- > Swivel armchair with central steel base, kick back device and upholstered polypropylene shell.
- > Fauteuil avec pietement central pivotant en acier avec mecanisme de retour. Coque en polypropylène rembourrée.
- > Armlehnstuhl mit Untergestell und mittlerem Standfuss aus Stahl mit Ruedckdrehaematik. Sitzfläche aus Polypropylen und Bezug auf Stoff.
- > Sillón con estructura columna central en acero, con sistema de vuelta. Carcasa en polipropileno tapizada.



600

- > Poltroncina con telaio a basamento centrale in acciaio, girevole. Seduta in polipropilene.
- > Swivel armchair with central steel base. Polypropylene shell.
- > Fauteuil avec pietement central pivotant en acier. Coque en polypropylène.
- > Armlehnstuhl mit Untergestell und mittlerem Standfuss aus Stahl, drehbar. Sitzfläche aus Polypropylen.
- > Sillón con estructura columna central en acero, giratoria. Carcasa en polipropileno.



600M

- > Poltroncina con seduta in polipropilene, imbottita. Telaio a basamento centrale in acciaio, girevole.
- > Swivel armchair with central steel base. Upholstered polypropylene shell.
- > Fauteuil avec pietement central pivotant en acier. Coque en polypropylène rembourrée.
- > Armlehnstuhl mit Untergestell und mittlerem Standfuss aus Stahl, drehbar. Sitzfläche aus Polypropylen und Bezug aus Stoff.
- > Sillón con estructura columna central en acero, giratoria. Carcasa en polipropileno tapizada.



604

- > Poltroncina lounge con telaio 4 gambe in acciaio, seduta in polipropilene.
- > Lounge armchair with steel frame, 4 legs. Polypropylene shell.
- > Fauteuil lounge avec châssis en acier 4 pieds et coque en polypropylène.
- > Lounge Armlehnstuhl mit 4-beinigem Stahlgestell. Sitzfläche aus Polypropylen.
- > Sillón lounge con estructura 4 patas en acero. Carcasa en polipropileno.



604M

- > Poltroncina lounge con seduta in polipropilene, imbottita. Telaio 4 gambe in tubo acciaio.
- > Lounge armchair with steel frame, 4 legs. Upholstered polypropylene shell.
- > Fauteuil lounge avec châssis en acier 4 pieds et coque en polypropylène rembourrée.
- > Lounge Armlehnstuhl mit 4-beinigem Stahlgestell. Sitzfläche aus Polypropylen und Bezug aus Stoff.
- > Sillón lounge con estructura 4 patas en acero. Carcasa en polipropileno tapizada.

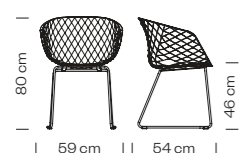

Peso / Weight / Poids / Gewicht / Peso **7,6 kg**

Imballo / Packaging / Emballage / Verpackung / Embalaje **0,34 m³**

Pezzi per scatola / Pieces per box / Pièces par carton / Stücke in einem Karton / Piezas por caja **1**

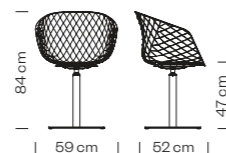

Peso / Weight / Poids / Gewicht / Peso **10,5 kg**

Imballo / Packaging / Emballage / Verpackung / Embalaje **0,34 m³**

Pezzi per scatola / Pieces per box / Pièces par carton / Stücke in einem Karton / Piezas por caja **1**

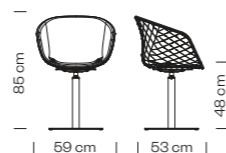

Peso / Weight / Poids / Gewicht / Peso **18,7 kg**

Imballo / Packaging / Emballage / Verpackung / Embalaje **0,34 m³**

Pezzi per scatola / Pieces per box / Pièces par carton / Stücke in einem Karton / Piezas por caja **1**

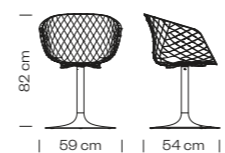

Peso / Weight / Poids / Gewicht / Peso **10,6 kg**

Imballo / Packaging / Emballage / Verpackung / Embalaje **0,34 m³**

Pezzi per scatola / Pieces per box / Pièces par carton / Stücke in einem Karton / Piezas por caja **1**

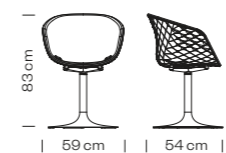

Peso / Weight / Poids / Gewicht / Peso **13,5 kg**

Imballo / Packaging / Emballage / Verpackung / Embalaje **0,34 m³**

Pezzi per scatola / Pieces per box / Pièces par carton / Stücke in einem Karton / Piezas por caja **1**

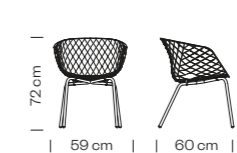

Peso / Weight / Poids / Gewicht / Peso **6,35 kg**

Imballo / Packaging / Emballage / Verpackung / Embalaje **0,31 m³**

Pezzi per scatola / Pieces per box / Pièces par carton / Stücke in einem Karton / Piezas por caja **1**

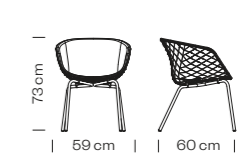

Peso / Weight / Poids / Gewicht / Peso **9,25 kg**

Imballo / Packaging / Emballage / Verpackung / Embalaje **0,31 m³**

Pezzi per scatola / Pieces per box / Pièces par carton / Stücke in einem Karton / Piezas por caja **1**



597-DP

- > Poltroncina con telaio a 5 razze in alluminio, girevole. Seduta in polipropilene.
- > Swivel armchair with 5 ways aluminium frame. Polypropylene shell.
- > Fauteuil pivotant avec châssis en aluminium 5 branches avec patins. Coque en polypropylène.
- > Armlehnstuhl mit Aluminiumgestell, drehbar und mit 5-armigem Fusskreuz. Sitzfläche aus Polypropylen.
- > Sillón con estructura 5 radios en aluminio, giratoria, carcasa en polipropileno.



597M-DP

- > Poltroncina con seduta in polipropilene, imbottita. Telaio a 5 razze in alluminio, girevole.
- > Swivel armchair with 5 ways aluminium frame. Upholstered polypropylene shell.
- > Fauteuil pivotant avec châssis en aluminium 5 branches avec patins. Coque en polypropylène rembourrée.
- > Armlehnstuhl mit Aluminiumgestell, drehbar und mit 5-armigem Fusskreuz. Sitzfläche aus Polypropylen und Bezug aus Stoff.
- > Sillón con estructura 5 radios en aluminio, giratoria, carcasa en polipropileno tapizada.



597-DR

- > Poltroncina con telaio a 5 razze in alluminio, girevole, su ruote. Seduta in polipropilene.
- > Swivel armchair with 5 ways on castors, aluminium frame. Polypropylene shell.
- > Fauteuil pivotant avec châssis en aluminium 5 branches avec roulettes. Coque en polypropylène.
- > Armlehnstuhl mit Aluminiumgestell, drehbar und mit 5-armigem Fusskreuz und Rollen. Sitzfläche aus Polypropylen.
- > Sillón con estructura 5 radios en aluminio, giratoria, con ruedas, carcasa en polipropileno.



597M-DR

- > Poltroncina con seduta in polipropilene, imbottita. Telaio a 5 razze in alluminio, girevole, su ruote.
- > Swivel armchair with 5 ways on castors, aluminium frame. Upholstered polypropylene shell.
- > Fauteuil pivotant avec châssis en aluminium 5 branches avec roulettes. Coque en polypropylène rembourrée.
- > Armlehnstuhl mit Aluminiumgestell, drehbar und mit 5-armigem Fusskreuz und Rollen. Sitzfläche aus Polypropylen und Bezug auf Stoff.
- > Sillón con estructura 5 radios en aluminio, giratoria, con ruedas, carcasa en polipropileno tapizada.

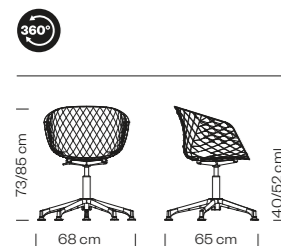

Peso / Weight / Poids / Gewicht / Peso **7,2 kg**

Imballo / Packaging / Emballage / Verpackung / Embalaje **0,39 m³**

Pezzi per scatola / Pieces per box / Pièces par carton / Stücke in einem Karton / Piezas por caja **1**

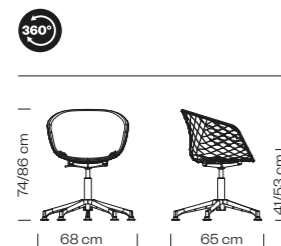

Peso / Weight / Poids / Gewicht / Peso **9,5 kg**

Imballo / Packaging / Emballage / Verpackung / Embalaje **0,39 m³**

Pezzi per scatola / Pieces per box / Pièces par carton / Stücke in einem Karton / Piezas por caja **1**

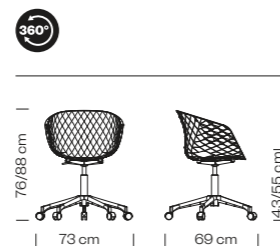

Peso / Weight / Poids / Gewicht / Peso **7,2 kg**

Imballo / Packaging / Emballage / Verpackung / Embalaje **0,39 m³**

Pezzi per scatola / Pieces per box / Pièces par carton / Stücke in einem Karton / Piezas por caja **1**

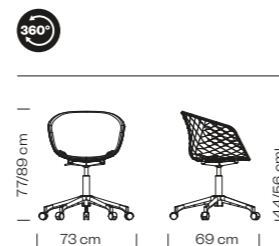

Peso / Weight / Poids / Gewicht / Peso **9,5 kg**

Imballo / Packaging / Emballage / Verpackung / Embalaje **0,39 m³**

Pezzi per scatola / Pieces per box / Pièces par carton / Stücke in einem Karton / Piezas por caja **1**

TE

- > Finiture seduta (vedi p. 359)
- > Seat finishes (see p. 359)
- > Finitions de l'assise (voir p. 359)
- > Sitzfertigung (sehen S. 359)
- > Acabados asiento (ver p. 359)

PP

- > Finiture seduta
- > Seat finishes
- > Finitions de l'assise
- > Sitzfertigung
- > Acabados asiento



AC

- > Finiture telaio (vedi p. 395)
- > Frame finishes (see p. 395)
- > Finitions piètement (voir p. 395)
- > Gestell fertigung (sehen S. 395)
- > Acabados estructura (ver p. 395)

AL VR

- > Finiture telaio
- > Frame finishes
- > Finitions piètement
- > Gestell fertigung
- > Acabados estructura



AL PSH

- > Finiture telaio (vedi p. 398)
- > Frame finishes (see p. 398)
- > Finitions piètement (voir p. 398)
- > Gestell fertigung (sehen S. 398)
- > Acabados estructura (ver p. 398)

LE

- > Finiture telaio
- > Frame finishes
- > Finitions piètement
- > Gestell fertigung
- > Acabados estructura











kontea

design
Carlo Bimbi Design, 2014



586

- > Poltroncina con telaio a 4 gambe in tubo acciaio. Sedile e schienale in tessuto.
- > Armchair with 4 legs steel frame and upholstered seat and back.
- > Fauteuil avec châssis 4 pieds en acier. Assise et dossier en tissu.
- > Armlehnstuhl mit 4-beinigem Stahlgestell. Gepolsterte Sitzfläche und Rückenlehne.
- > Sillón con estructura tubular 4 patas en acero. Asiento y respaldo tapizados.



587

- > Poltroncina con telaio a basamento centrale girevole in acciaio. Sedile e schienale in tessuto.
- > Swivel armchair with central steel base and upholstered seat and back.
- > Fauteuil pivotant avec piétement central en acier. Assise et dossier en tissu.
- > Armlehnstuhl mit Gestell auf zentralem, drehbarem Standfuss aus Stahl. Gepolsterte Sitzfläche und Rückenlehne.
- > Sillón con estructura columna central en acero, giratoria. Asiento y respaldo tapizados.



588

- > Poltroncina con telaio a 4 razze in tubo acciaio. Sedile e schienale in tessuto.
- > Armchair with 4 ways steel frame. Upholstered seat and back.
- > Fauteuil avec châssis 4 branches en acier. Assise et dossier en tissu.
- > Armlehnstuhl mit 4-armigem Fusskreuz aus Stahl. Gepolsterte Sitzfläche und Rückenlehne.
- > Sillón con estructura tubular 4 radios en acero. Asiento y respaldo tapizados.



590

- > Poltroncina con telaio a 4 gambe in faggio. Sedile e schienale in tessuto.
- > Armchair with beech wood frame, 4 legs. Upholstered seat and back.
- > Fauteuil avec châssis 4 pieds en hêtre. Assise et dossier en tissu.
- > Armlehnstuhl mit 4-beinigem Buchenholzgestell. Gepolsterte Sitzfläche und Rückenlehne.
- > Sillón con estructura 4 patas en madera de haya. Asiento y respaldo tapizados.

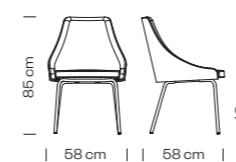

Peso / Weight / Poids / Gewicht / Peso **9 kg**

Imballo / Packaging / Emballage / Verpackung / Embalaje **0,34 m³**

Pezzi per scatola / Pieces per box / Pièces par carton / Stücke in einem Karton / Piezas por caja **1**

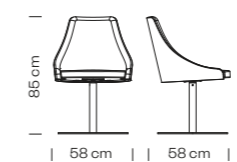

Peso / Weight / Poids / Gewicht / Peso **20 kg**

Imballo / Packaging / Emballage / Verpackung / Embalaje **0,34 m³**

Pezzi per scatola / Pieces per box / Pièces par carton / Stücke in einem Karton / Piezas por caja **1**

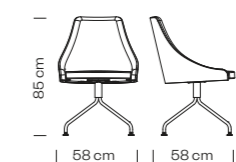

Peso / Weight / Poids / Gewicht / Peso **9 kg**

Imballo / Packaging / Emballage / Verpackung / Embalaje **0,34 m³**

Pezzi per scatola / Pieces per box / Pièces par carton / Stücke in einem Karton / Piezas por caja **1**

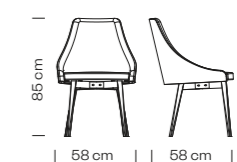

Peso / Weight / Poids / Gewicht / Peso **9,4 kg**

Imballo / Packaging / Emballage / Verpackung / Embalaje **0,34 m³**

Pezzi per scatola / Pieces per box / Pièces par carton / Stücke in einem Karton / Piezas por caja **1**



307

- > Sgabello con telaio a 4 gambe in tubo acciaio. Sedile e schienale in tessuto.
- > Barstool with 4 legs steel frame. Upholstered seat and back.
- > Tabouret avec châssis en acier 4 pieds. Assise et dossier en tissu.
- > Barhocker mit 4-beinigem Stahlgestell. Gepolsterte Sitzfläche und Rückenlehne.
- > Taburete con estructura tubular 4 patas en acero. Asiento y respaldo tapizados.



310

- > Sgabello con telaio a basamento centrale girevole in acciaio. Sedile e schienale in tessuto.
- > Swivel barstool with central steel frame. Upholstered seat and back.
- > Tabouret pivotant avec piétement central en acier. Assise et dossier en tissu.
- > Barhocker mit Gestell auf zentralem, drehbarem Standfuss aus Stahl. Gepolsterte Sitzfläche und Rückenlehne.
- > Taburete con estructura columna central en acero, giratoria. Asiento y respaldo tapizados.

360°

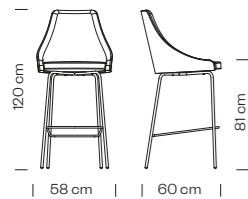

Peso / Weight / Poids / Gewicht / Peso **9,3 kg**

Imballo / Packaging / Emballage / Verpackung / Embalaje **0,44 m³**

Pezzi per scatola / Pieces per box / Pièces par carton / Stücke in einem Karton / Piezas por caja **1**

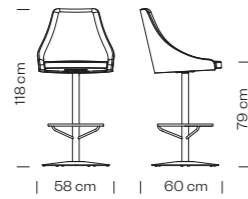

Peso / Weight / Poids / Gewicht / Peso **21,2 kg**

Imballo / Packaging / Emballage / Verpackung / Embalaje **0,44 m³**

Pezzi per scatola / Pieces per box / Pièces par carton / Stücke in einem Karton / Piezas por caja **1**

TE

- > Finiture seduta (vedi p. 359)
- > Seat finishes (see p. 359)
- > Finitions de l'assise (voir p. 359)
- > Sitzfertigung (sehen S. 359)
- > Acabados asiento (ver p. 359)

AC

- > Finiture telaio (vedi p. 395)
- > Frame finishes (see p. 395)
- > Finitions piètement (voir p. 395)
- > Gestell fertigung (sehen S. 395)
- > Acabados estructura (ver p. 395)

LE

- > Finiture telaio
- > Frame finishes
- > Finitions piètement
- > Gestell fertigung
- > Acabados estructura

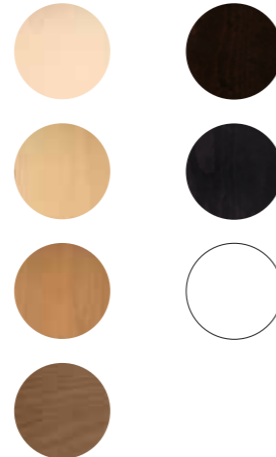

kyk

design
Carlo Bimbi Design, 2014



542

- > Poltrona con telaio a 4 gambe in faggio. Sedile e schienale in tessuto.
- > Armchair with beech wood frame, 4 legs. Upholstered seat and back.
- > Fauteuil avec châssis 4 pieds en hêtre. Assise et dossier en tissu.
- > Sessel mit 4-beinigem Buchenholzgestell. Gepolsterte Sitzfläche und Rückenlehne.
- > Sillón con estructura 4 patas en madera de haya. Asiento y respaldo tapizados.

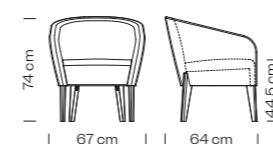

Peso / Weight / Poids / Gewicht / Peso **13 kg**

Imballo / Packaging / Emballage / Verpackung / Embalaje **0,39 m³**

Pezzi per scatola / Pieces per box / Pièces par carton / Stücke in einem Karton / Piezas por caja **1**

543

- > Divano con telaio a 4 gambe in faggio. Sedile e schienale in tessuto.
- > Sofa with beech wood frame, 4 legs. Upholstered seat and back.
- > Canapé avec châssis 4 pieds en hêtre. Assise et dossier en tissu.
- > Sofa mit 4-beinigem Buchenholzgestell. Gepolsterte Sitzfläche und Rückenlehne.
- > Sofa con estructura 4 patas en madera de haya. Asiento y respaldo tapizados.

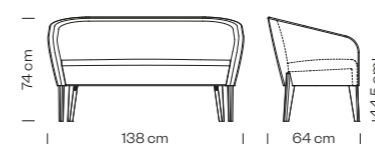

Peso / Weight / Poids / Gewicht / Peso **22 kg**

Imballo / Packaging / Emballage / Verpackung / Embalaje **0,74 m³**

Pezzi per scatola / Pieces per box / Pièces par carton / Stücke in einem Karton / Piezas por caja **1**

TE

- > Finiture seduta (vedi p. 359)
- > Seat finishes (see p. 359)
- > Finitions de l'assise (voir p. 359)
- > Sitzfertigung (sehen S. 359)
- > Acabados asiento (ver p. 359)

LE

- > Finiture telaio
- > Frame finishes
- > Finitions piètement
- > Gestell fertigungen
- > Acabados estructura

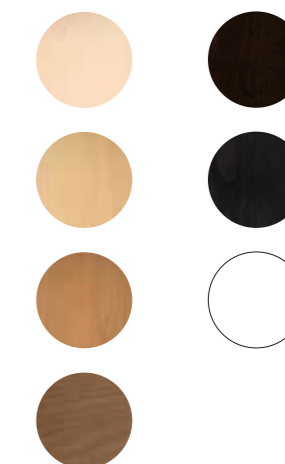



abaco+

design
rdm, 2013



172



812

- > Sistema sedute multiple. Sedile e schienale imbottiti. Telaio in tubo acciaio. Modulo lineare L 60 cm.
- > Modular seating system. Upholstered seat and back. Steel frame. Linear module L 60 cm.
- > Système d'assises multiples. Assise et dossier rembourrés. Châssis en acier. Element linéaire de 60 cm.
- > System aus mehreren Sitzmöbeln. Gepolsterte Sitzfläche und Rückenlehne. Gestell aus Stahlrohren. Lineares Modul mit einer Länge von 60 cm.
- > Sistema de asientos múltiples. Asiento y respaldo tapizados. Estructura tubular en acero. Módulo lineal L 60 cm.

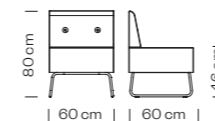

Peso / Weight / Poids / Gewicht / Peso **19 kg**

Imballo / Packaging / Emballage / Verpackung / Embalaje **0,34 m³**

Pezzi per scatola / Pieces per box / Pièces par carton / Stücke in einem Karton / Piezas por caja **1**



813

- > Sistema sedute multiple. Sedile e schienale imbottiti. Telaio in tubo acciaio. Modulo lineare L 120 cm.
- > Modular seating system. Upholstered seat and back. Steel frame. Linear module L 120 cm.
- > Système d'assises multiples. Assise et dossier rembourrés. Châssis en acier. Element linéaire de 120 cm.
- > System aus mehreren Sitzmöbeln. Gepolsterte Sitzfläche und Rückenlehne. Gestell aus Stahlrohren. Lineares Modul mit einer Länge von 120 cm.
- > Sistema de asientos múltiples. Asiento y respaldo tapizados. Estructura tubular en acero. Módulo lineal L 120 cm.



Peso / Weight / Poids / Gewicht / Peso **43 kg**

Imballo / Packaging / Emballage / Verpackung / Embalaje **0,66 m³**

Pezzi per scatola / Pieces per box / Pièces par carton / Stücke in einem Karton / Piezas por caja **1**



814

- > Sistema sedute multiple. Sedile e schienale imbottiti. Telaio in tubo acciaio. Modulo angolare.
- > Modular seating system. Upholstered seat and back. Steel frame. Corner module.
- > Système d'assises multiples. Assise et dossier rembourrés. Châssis en acier. Element d'angle.
- > System aus mehreren Sitzmöbeln. Gepolsterte Sitzfläche und Rückenlehne. Gestell aus Stahlrohren. Eckmodul.
- > Sistema de asientos múltiples. Asiento y respaldo tapizados. Estructura tubular en acero. Módulo de esquina.

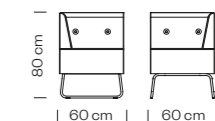

Peso / Weight / Poids / Gewicht / Peso **23 kg**

Imballo / Packaging / Emballage / Verpackung / Embalaje **0,34 m³**

Pezzi per scatola / Pieces per box / Pièces par carton / Stücke in einem Karton / Piezas por caja **1**

173



815

- > Sistema sedute multiple.
Sedile imbottito. Telaio in tubo acciaio. Modulo pouf L 60 cm.
- > Modular seating system.
Upholstered bench. Steel frame. Module L 60 cm.
- > Système d'assises multiples.
Assise rembourrée. Châssis en acier. Element pouf de 60 cm.
- > System aus mehreren Sitzmöbeln.
Gepolsterte Sitzfläche. Gestell aus Stahlrohren. Poufmodul mit einer Länge von 60 cm.
- > Sistema de asientos múltiples.
Asiento tapizado.
Estructura tubular en acero.
Módulo pouf L 60 cm.

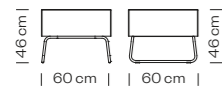

Peso / Weight / Poids / Gewicht / Peso **14 kg**

Imballo / Packaging / Emballage / Verpackung / Embalaje **0,28 m³**

Pezzi per scatola / Pieces per box / Pièces par carton / Stücke in einem Karton / Piezas por caja **1**



816

- > Sistema sedute multiple.
Sedile imbottito. Telaio in tubo acciaio. Modulo pouf L 120 cm.
- > Modular seating system.
Upholstered seat and back. Steel frame. Pouf module L 120 cm.
- > Système d'assises multiples.
Upholstered bench. Steel frame. Module L 120 cm.
- > Système d'assises multiples.
Assise rembourrée. Châssis en acier. Element pouf de 120 cm
- > Sistema de asientos múltiples.
Asiento tapizado.
Estructura tubular en acero.
Módulo pouf L 120 cm.

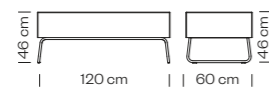

Peso / Weight / Poids / Gewicht / Peso **33 kg**

Imballo / Packaging / Emballage / Verpackung / Embalaje **0,40 m³**

Pezzi per scatola / Pieces per box / Pièces par carton / Stücke in einem Karton / Piezas por caja **1**



817

- > Sistema sedute multiple.
Rivestimento a parete in tessuto. Modulo lineare L 60 cm.
- > Modular seating system.
Upholstered wall panel. Module L 60 cm.
- > Système d'assises multiples.
Revêtement mural en tissu. Element lineaire de 60 cm.
- > System aus mehreren Sitzmöbeln.
Gepolsterte Wandverkleidung. Lineares Modul mit Länge von 60 cm.
- > Sistema de asientos múltiples.
Revestimiento mural en tejido. Módulo lineal L 60 cm.

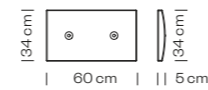

Peso / Weight / Poids / Gewicht / Peso **2 kg**

Imballo / Packaging / Emballage / Verpackung / Embalaje **0,18 m³**

Pezzi per scatola / Pieces per box / Pièces par carton / Stücke in einem Karton / Piezas por caja **4**

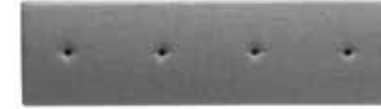

818

- > Sistema sedute multiple.
Rivestimento a parete in tessuto. Modulo lineare L 120 cm.
- > Modular seating system.
Upholstered wall panel. Module L 120 cm.
- > Système d'assises multiples.
Revêtement mural en tissu. Element lineaire de 120 cm.
- > System aus mehreren Sitzmöbeln.
Gepolsterte Wandverkleidung. Lineares Modul mit Länge von 120 cm.
- > Sistema de asientos múltiples.
Revestimiento mural en tejido. Módulo lineal L 120 cm.

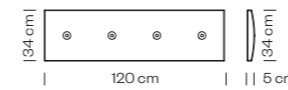

Peso / Weight / Poids / Gewicht / Peso **4 kg**

Imballo / Packaging / Emballage / Verpackung / Embalaje **0,18 m³**

Pezzi per scatola / Pieces per box / Pièces par carton / Stücke in einem Karton / Piezas por caja **4**

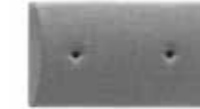

819

- > Sistema sedute multiple.
Rivestimento a parete in tessuto. Modulo angolare (2 pezzi).
- > Modular seating system.
Upholstered wall panel. Corner module (2 pieces).
- > Système d'assises multiples.
Revêtement mural en tissu. Element d'angle (2 pièces).
- > System aus mehreren Sitzmöbeln.
Gepolsterte Wandverkleidung. Eckmodul (2 Stücke).
- > Sistema de asientos múltiples.
Revestimiento mural en tejido. Módulo de esquina (2 piezas).

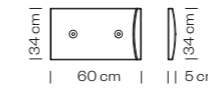

Peso / Weight / Poids / Gewicht / Peso **4 kg**

Imballo / Packaging / Emballage / Verpackung / Embalaje **0,18 m³**

Pezzi per scatola / Pieces per box / Pièces par carton / Stücke in einem Karton / Piezas por caja **2**

TE

- > Finiture seduta (vedi p. 359)
- > Seat finishes (see p. 359)
- > Finitions de l'assise (voir p. 359)
- > Sitzfertigung (sehen S. 359)
- > Acabados asiento (ver p. 359)

AC

- > Finiture telaio (vedi p. 395)
- > Frame finishes (see p. 395)
- > Finitions piètement (voir p. 395)
- > Gestell fertigungen (sehen S. 395)
- > Acabados estructura (ver p. 395)



Accessori / Accessories / Accessoires / Zubehoer / Accessories

- > Cuscini cilindrici
- > Tubular cushions
- > Coussins cylindriques
- > Kissen zylinder
- > Cojines cilindricos

playa

design
Carlo Bimbi Design, 2013



203

- > Sistema sedute multiple. Seduta lineare in polietilene stampato in rotazionale. Modulo lineare.
- > Modular seating system, rotational moulding polyethylene. Linear module.
- > Banquettes multiples. Canapé en polyéthylène roto-moulé. Module lineaire.
- > System aus mehreren Sitzmöbeln. Lineares Modul aus rotationsgeformtem Polyäthylen.
- > Sistema de asientos múltiples en polietileno moldeado rotativo. Módulo lineal con respaldo.

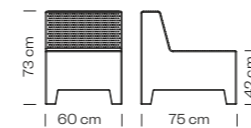

Peso / Weight / Poids / Gewicht / Peso **9 kg**

Imballo / Packaging / Emballage / Verpackung / Embalaje **0,58 m³**

Pezzi per scatola / Pieces per box / Pièces par carton / Stücke in einem Karton / Piezas por caja **2**



203C

- > Cuscino opzionale in tessuto per esterno (da rimuovere in caso di pioggia). Modulo lineare.
- > Optional cushion for outdoor use, to be removed in case of bad weather. Linear module.
- > Coussin optionel rembourré en tissu à l'eau pour usage extérieur, pour canapé, à rentrer en cas de intempéries. Module lineaire.
- > Optionales Außengewebekissen (im Falle von Regen zu entfernen). Lineares Modul.
- > Cojín opcional en tejido para exteriores (por removerse en caso de lluvia). Módulo lineal.



204

- > Sistema sedute multiple. Seduta angolare in polietilene stampato in rotazionale. Modulo angolare.
- > Modular seating system, rotational moulding polyethylene. Corner module.
- > Banquettes multiples. Canapé en polyéthylène roto-moulé. Module d'angle.
- > System aus mehreren Sitzmöbeln. Eckiges Modul aus rotationsgeformtem Polyäthylen.
- > Sistema de asientos múltiples en polietileno moldeado rotativo. Módulo de esquina con respaldo.

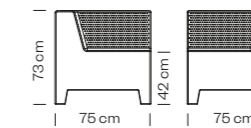

Peso / Weight / Poids / Gewicht / Peso **12 kg**

Imballo / Packaging / Emballage / Verpackung / Embalaje **0,47 m³**

Pezzi per scatola / Pieces per box / Pièces par carton / Stücke in einem Karton / Piezas por caja **1**



204C

- > Cuscino opzionale in tessuto per esterno (da rimuovere in caso di pioggia). Modulo angolare.
- > Optional cushion for outdoor use, to be removed in case of bad weather. Corner module.
- > Coussin optionel rembourré en tissu à l'eau pour usage extérieur, pour canapé, à rentrer en cas de intempéries. Module d'angle.
- > Optionales Außengewebekissen (im Falle von Regen zu entfernen). Eckiges Modul.
- > Cojín opcional en tejido para exteriores (por removerse en caso de lluvia). Módulo de esquina.





205

- > Sistema sedute multiple. Pouf in polietilene stampato in rotazionale. Modulo pouf.
- > Multiple seating system, rotational moulding polyethylene. Pouf module.
- > Banquettes multiples. Pouf en polyéthylène roto-moulé.
- > System aus mehreren Sitzmöbeln. Hocker aus rotationsgformtem Polyäthylen.
- > Sistema de asientos múltiples en polietileno moldeado rotativo. Módulo pouf.

PE

- > Finiture seduta
- > Seat finishes
- > Finitions de l'assise
- > Sitzfertigung
- > Acabados asiento



TE

- > Finiture seduta
- > Seat finishes
- > Finitions de l'assise
- > Sitzfertigung
- > Acabados asiento

solo / only / seulement /
nur / solamente
Solids & Stripes
p. 369



178



179

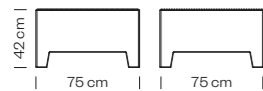

Peso / Weight /
Poids / Gewicht / Peso **8,6 kg**

Imballo / Packaging /
Emballage / Verpackung /
Embalaje **0,28 m³**

Pezzi per scatola /
Pieces per box /
Pièces par carton /
Stücke in einem Karton /
Piezas por caja **2**

zero

design
Carlo Bimbi Design, 2013



208

- > Sistema sedute multiple in tubo acciaio con trattamento cataforesi. Tessuto per esterno. Modulo lineare.
- > Modular sofa system with painted steel frame and cataphoresis-treatment. Fabric for outdoors. Linear module.
- > Banquettes multiples, châssis en tube d'acier traité en cataphorèse. Coussin en tissu. Module linéaire.
- > System aus mehreren Sitzmöbeln aus Stahlrohren mit Kataphorese. Gewebe für den Außenbereich. Lineares Modul.
- > Sistema de asientos múltiples con estructura tubular en acero con tratamiento de cataforesis. Asiento y respaldo tapizados con tejido para exteriores. Módulo lineal.

209

- > Sistema sedute multiple in tubo acciaio con trattamento cataforesi. Tessuto per esterno. Modulo angolare.
- > Modular sofa system with painted steel frame and cataphoresis-treatment. Fabric for outdoors. Corner module.
- > Banquettes multiples, châssis en tube d'acier traité en cataphorèse. Coussin en tissu. Module d'angle.
- > System aus mehreren Sitzmöbeln aus Stahlrohren mit Kataphorese. Gewebe für den Außenbereich. Eckiges Modul.
- > Sistema de asientos múltiples con estructura tubular en acero con tratamiento de cataforesis. Asiento y respaldo tapizados con tejido para exteriores. Módulo de esquina.

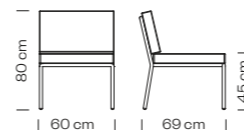

Peso / Weight / Poids / Gewicht / Peso **7,6 kg**

Imballo / Packaging / Emballage / Verpackung / Embalaje **0,50 m³**

Pezzi per scatola / Pieces per box / Pièces par carton / Stücke in einem Karton / Piezas por caja **2**

Impilabile / Stackable / Empilable / Stapelbar / Apilable **4***

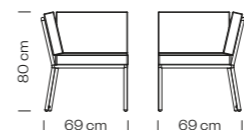

Peso / Weight / Poids / Gewicht / Peso **10,2 kg**

Imballo / Packaging / Emballage / Verpackung / Embalaje **0,45 m³**

Pezzi per scatola / Pieces per box / Pièces par carton / Stücke in einem Karton / Piezas por caja **2**

Impilabile / Stackable / Empilable / Stapelbar / Apilable **2***

TE

- > Finiture seduta
- > Seat finishes
- > Finitions de l'assise
- > Sitzfertigung
- > Acabados asiento

solo / only / seulement / nur / solamente

Solids & Stripes p. 369

AC

- > Finiture telaio (vedi p. 395)
- > Frame finishes (see p. 395)
- > Finitions piètement (voir p. 395)
- > Gestell fertigungen (sehen S. 395)
- > Acabados estructura (ver p. 395)

* Impilabile con cuscino smontato / Stackable without cushion / Empilable sans coussin / Stapelfähigkeit ohne Kissen / Apilable sin cojin



marka

design
Carlo Bimbi Design, 2012



566

- > Poltroncina con telaio a 4 gambe in acciaio. Sedile e schienale in tessuto.
- > Armchair with 4 legs steel frame. Upholstered seat and back.
- > Fauteuil avec châssis 4 pieds en acier. Assise et dossier en tissu.
- > Armlehnstuhl mit 4-beinigem Stahlgestell. Gepolsterte Sitzfläche und Rückenlehne.
- > Sillón con estructura tubular 4 patas en acero. Asiento y respaldo tapizados.



Peso / Weight / Poids / Gewicht / Peso **10 kg**

Imballo / Packaging / Emballage / Verpackung / Embalaje **0,34 m³**

Pezzi per scatola / Pieces per box / Pièces par carton / Stücke in einem Karton / Piezas por caja **1**



567

- > Poltroncina con telaio a basamento centrale girevole in acciaio. Sedile e schienale in tessuto.
- > Swivel armchair with central steel base. Upholstered seat and back.
- > Fauteuil pivotant avec piétement central en acier. Assise et dossier en tissu.
- > Armlehnstuhl mit Gestell auf zentralem, drehbarem Standfuss aus Stahl. Gepolsterte Sitzfläche und Rückenlehne.
- > Sillón con estructura columna central en acero, giratoria. Asiento y respaldo tapizados.

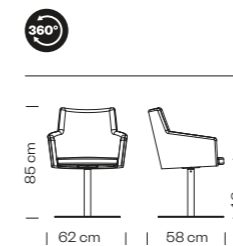

Peso / Weight / Poids / Gewicht / Peso **21 kg**

Imballo / Packaging / Emballage / Verpackung / Embalaje **0,34 m³**

Pezzi per scatola / Pieces per box / Pièces par carton / Stücke in einem Karton / Piezas por caja **1**



568

- > Poltroncina con telaio a 4 razze in tubo acciaio. Sedile e schienale in tessuto.
- > Armchair with 4 ways steel frame. Upholstered seat and back.
- > Fauteuil avec châssis 4 branches en acier. Assise et dossier en tissu.
- > Armlehnstuhl mit 4-beinigem Stahlgestell. Gepolsterte Sitzfläche und Rückenlehne.
- > Sillón con estructura 4 radios en acero. Asiento y respaldo tapizados.

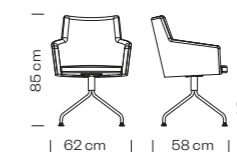

Peso / Weight / Poids / Gewicht / Peso **10 kg**

Imballo / Packaging / Emballage / Verpackung / Embalaje **0,34 m³**

Pezzi per scatola / Pieces per box / Pièces par carton / Stücke in einem Karton / Piezas por caja **1**



569-DP

- > Poltroncina con telaio in alluminio a 5 razze, girevole. Sedile e schienale in tessuto.
- > Swivel armchair with 5 ways aluminium frame. Upholstered seat and back.
- > Fauteuil pivotant avec châssis en aluminium 5 branches avec patins. Assise et dossier en tissu.
- > Armlehnstuhl mit Aluminiumgestell, drehbar und mit 5-armigem Fusskreuz. Gepolsterte Sitzfläche und Rückenlehne.
- > Sillón con estructura 5 radios en aluminio, giratoria. Asiento y respaldo tapizados.



Peso / Weight / Poids / Gewicht / Peso **12 kg**

Imballo / Packaging / Emballage / Verpackung / Embalaje **0,50 m³**

Pezzi per scatola / Pieces per box / Pièces par carton / Stücke in einem Karton / Piezas por caja **1**



569-DR

- > Poltroncina con telaio in alluminio a 5 razze, girevole, su ruote. Sedile e schienale in tessuto.
- > Swivel armchair with 5 ways on castors, aluminium frame. Upholstered seat and back.
- > Fauteuil pivotant avec châssis en aluminium 5 branches avec roulettes. Assise et dossier en tissu.
- > Armlehnstuhl mit Aluminiumgestell, drehbar und mit 5-armigem Fusskreuz und Rollen. Gepolsterte Sitzfläche und Rückenlehne.
- > Sillón con estructura 5 radios en aluminio, giratoria, con ruedas. Asiento y respaldo tapizados.



570

- > Poltroncina con telaio a 4 gambe in faggio. Sedile e schienale in tessuto.
- > Armchair with beech wood frame, 4 legs. Upholstered seat and back.
- > Fauteuil avec châssis 4 pieds en hêtre. Assise et dossier en tissu.
- > Armlehnstuhl mit 4-beinigem Buchenholzgestell. Gepolsterte Sitzfläche und Rückenlehne.
- > Sillón con estructura 4 patas en madera de haya. Asiento y respaldo tapizados.

TE

- > Finiture seduta (vedi p. 359)
- > Seat finishes (see p. 359)
- > Finitions de l'assise (voir p. 359)
- > Sitzfertigung (sehen S. 359)
- > Acabados asiento (ver p. 359)

AC

- > Finiture telaio (vedi p. 395)
- > Frame finishes (see p. 395)
- > Finitions piètement (voir p. 395)
- > Gestell fertigung (sehen S. 395)
- > Acabados estructura (ver p. 395)

AL PSH

- > Finiture telaio (vedi p. 398)
- > Frame finishes (see p. 398)
- > Finitions piètement (voir p. 398)
- > Gestell fertigung (sehen S. 398)
- > Acabados estructura (ver p. 398)

LE

- > Finiture telaio
- > Frame finishes
- > Finitions piètement
- > Gestell fertigung
- > Acabados estructura

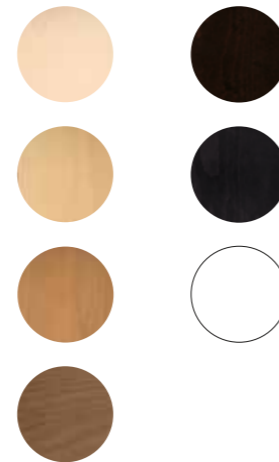

AL VR

- > Finiture telaio
- > Frame finishes
- > Finitions piètement
- > Gestell fertigung
- > Acabados estructura



360°

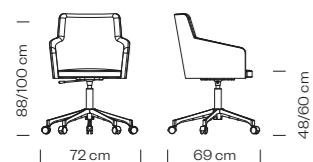

Peso / Weight / Poids / Gewicht / Peso **12 kg**

Imballo / Packaging / Emballage / Verpackung / Embalaje **0,50 m³**

Pezzi per scatola / Pieces per box / Pièces par carton / Stücke in einem Karton / Piezas por caja **1**

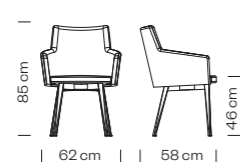

Peso / Weight / Poids / Gewicht / Peso **10,4 kg**

Imballo / Packaging / Emballage / Verpackung / Embalaje **0,34 m³**

Pezzi per scatola / Pieces per box / Pièces par carton / Stücke in einem Karton / Piezas por caja **1**

sharing

design
Giorgio Di Tullio, 2012



388

- > Sgabello con telaio in tubo acciaio.
Sedile in tessuto.
- > Barstool with steel frame.
Upholstered seat.
- > Tabouret avec châssis en acier.
Assise en tissu.
- > Barhocker mit Gestell aus
Stahlrohren. Gepolsterte
Sitzfläche.
- > Taburete con estructura tubular
en acero. Asiento tapizado.

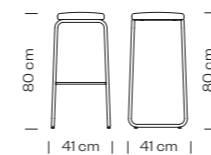

Peso / Weight /
Poids / Gewicht / Peso **5 kg**

Imballo / Packaging /
Emballage / Verpackung /
Embalaje **0,18 m³**

Pezzi per scatola /
Pieces per box /
Pièces par carton /
Stücke in einem Karton /
Piezas por caja **1**

TE

- > Finiture seduta
(vedi p. 359)
- > Seat finishes
(see p. 359)
- > Finitions de l'assise
(voir p. 359)
- > Sitzfertigung
(sehen S. 359)
- > Acabados asiento
(ver p. 359)

AC

- > Finiture telaio
(vedi p. 395)
- > Frame finishes
(see p. 395)
- > Finitions piètement
(voir p. 395)
- > Gestell fertigungen
(sehen S. 395)
- > Acabados estructura
(ver p. 395)



uni

design
Francesco Geraci, 2011



190



191





550

- > Sedia con telaio a 4 gambe in tubo acciaio. Seduta in polipropilene.
- > Chair with steel frame, 4 legs. Polypropylene shell.
- > Chaise avec châssis en acier 4 pieds et coque en polypropylène.
- > Stuhl mit 4-beinigem Stahlgestell. Sitzfläche aus Polypropylen.
- > Silla con estructura tubular 4 patas en acero, carcasa en polipropileno.



550M

- > Sedia con seduta in polipropilene, imbottita. Telaio a 4 gambe in tubo acciaio.
- > Chair with steel frame, 4 legs. Upholstered polypropylene shell.
- > Chaise avec châssis en acier 4 pieds et coque en polypropylène rembourrée.
- > Stuhl mit Sitzfläche aus Polypropylen und Bezug auf Stoff. 4-beiniger Stahlgestell.
- > Silla con estructura tubular 4 patas en acero, carcasa en polipropileno tapizada.



378

- > Sgabello con telaio a 4 gambe in tubo acciaio. Seduta in polipropilene.
- > Barstool with steel frame, 4 legs. Polypropylene shell.
- > Tabouret avec chassis 4 pieds en acier. Coque en polypropylène.
- > Barhocker mit 4-beinigem Stahlgestell. Schale aus Polypropylen.
- > Taburete con estructura tubular 4 patas en acero, carcasa en polipropileno.



378B

- > Sgabello con telaio a 4 gambe in tubo acciaio. Seduta in polipropilene. Versione seduta H 65 cm.
- > Barstool with steel frame, 4 legs. Polypropylene shell. Version with seat-height H 65 cm.
- > Tabouret avec chassis 4 pieds en acier. Coque en polypropylène. Version hauteur assise 65 cm.
- > Barhocker mit 4-beinigem Stahlgestell. Schale aus Polypropylen. Sitzhöhe 65 cm.
- > Taburete con estructura tubular 4 patas en acero, carcasa en polipropileno. Altura asiento 65 cm.



378M

- > Sgabello con seduta in polipropilene, imbottita. Telaio a 4 gambe in tubo acciaio.
- > Barstool with steel frame, 4 legs. Upholstered polypropylene shell.
- > Tabouret avec chassis 4 pieds en acier. Coque en polypropylène rembourrée.
- > Barhocker mit Sitzfläche aus Polypropylen und Bezug auf Stoff. Gestell mit 4-beinigem Stahlrohren.
- > Taburete con estructura tubular 4 patas en acero, carcasa en polipropileno tapizada.



380

- > Sgabello con telaio a basamento centrale girevole in acciaio, con meccanismo di ritorno. Seduta in polipropilene.
- > Swivel barstool with central steel base and kick-back device. Polypropylene shell.
- > Tabouret avec pietement central pivotant en acier avec mecanisme de retour. Coque en polypropylène.
- > Barhocker mit Untergestell und mittlerem Standfuss aus Stahl mit Rueckdrehautomatik. Sitzfläche aus Polypropylen.
- > Taburete con estructura columna central en acero, con sistema de vuelta. Carcasa en polipropileno.



380B

- > Sgabello con telaio a basamento centrale girevole in acciaio, con meccanismo di ritorno. Seduta in polipropilene. Versione seduta H 65 cm.
- > Swivel barstool with central steel base and kick-back device. Polypropylene shell. Version seat-height H 65 cm.
- > Tabouret avec pietement central pivotant en acier avec mecanisme de retour. Coque en polypropylène rembourrée.
- > Barhocker mit Untergestell und mittlerem Standfuss aus Stahl mit Rueckdrehautomatik. Sitzfläche aus Polypropylen.
- > Taburete con estructura columna central en acero, con sistema de vuelta. Carcasa en polipropileno. Altura asiento 65 cm.



380M

- > Sgabello con seduta in polipropilene, imbottita. Telaio a basamento centrale girevole in acciaio e meccanismo di ritorno.
- > Swivel barstool with central steel base and kick-back device. Upholstered polypropylene shell.
- > Tabouret avec pietement central pivotant en acier avec mecanisme de retour. Coque en polypropylène rembourrée.
- > Barhocker mit Sitzfläche aus Polypropylen und Bezug auf Stoff. Gestell mit mittlerem Standfuss aus Stahl und Rueckdrehautomatik.
- > Taburete con estructura columna central en acero, con sistema de vuelta. Carcasa en polipropileno tapizada.



Peso / Weight / Poids / Gewicht / Peso **4,6 kg**

Imballo / Packaging / Emballage / Verpackung / Embalaje **0,36 m³**

Pezzi per scatola / Pieces per box / Pièces par carton / Stücke in einem Karton / Piezas por caja **5**

Impilabile / Stackable / Empilable / Stapelbar / Apilable **8**



Peso / Weight / Poids / Gewicht / Peso **6,75 kg**

Imballo / Packaging / Emballage / Verpackung / Embalaje **0,24 m³**

Pezzi per scatola / Pieces per box / Pièces par carton / Stücke in einem Karton / Piezas por caja **1**

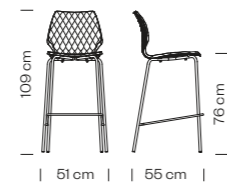

Peso / Weight / Poids / Gewicht / Peso **6,8 kg**

Imballo / Packaging / Emballage / Verpackung / Embalaje **0,46 m³**

Pezzi per scatola / Pieces per box / Pièces par carton / Stücke in einem Karton / Piezas por caja **4**

Impilabile / Stackable / Empilable / Stapelbar / Apilable **4**

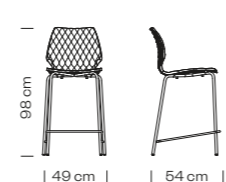

Peso / Weight / Poids / Gewicht / Peso **6,5 kg**

Imballo / Packaging / Emballage / Verpackung / Embalaje **0,46 m³**

Pezzi per scatola / Pieces per box / Pièces par carton / Stücke in einem Karton / Piezas por caja **4**

Impilabile / Stackable / Empilable / Stapelbar / Apilable **4**

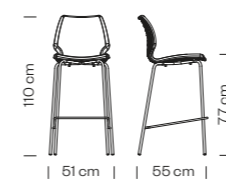

Peso / Weight / Poids / Gewicht / Peso **8,95 kg**

Imballo / Packaging / Emballage / Verpackung / Embalaje **0,35 m³**

Pezzi per scatola / Pieces per box / Pièces par carton / Stücke in einem Karton / Piezas por caja **1**

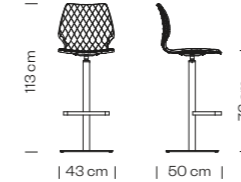

Peso / Weight / Poids / Gewicht / Peso **17 kg**

Imballo / Packaging / Emballage / Verpackung / Embalaje **0,29 m³**

Pezzi per scatola / Pieces per box / Pièces par carton / Stücke in einem Karton / Piezas por caja **1**

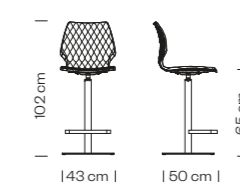

Peso / Weight / Poids / Gewicht / Peso **16,7 kg**

Imballo / Packaging / Emballage / Verpackung / Embalaje **0,29 m³**

Pezzi per scatola / Pieces per box / Pièces par carton / Stücke in einem Karton / Piezas por caja **1**

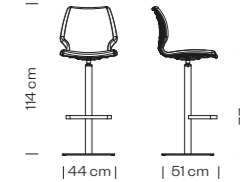

Peso / Weight / Poids / Gewicht / Peso **19,2 kg**

Imballo / Packaging / Emballage / Verpackung / Embalaje **0,29 m³**

Pezzi per scatola / Pieces per box / Pièces par carton / Stücke in einem Karton / Piezas por caja **1**





562

- > Sedia con telaio a 4 gambe in faggio. Seduta in polipropilene.
- > Chair with beech wood frame, 4 legs. Polypropylene shell.
- > Chaise avec châssis 4 pieds en hêtre. Coque en polypropylène.
- > Stuhl mit 4-beinigem Buchenholzgestell. Sitzfläche aus Polypropylen.
- > Silla con estructura 4 patas en madera de haya. Carcasa en polipropileno.



562M

- > Sedia con seduta in polipropilene, imbottita. Telaio a 4 gambe in faggio.
- > Chair with beech wood frame, 4 legs. Upholstered polypropylene shell.
- > Chaise avec châssis 4 pieds en hêtre. Coque en polypropylène rembourrée.
- > Stuhl mit Sitzfläche aus Polypropylen und Bezug aus Stoff. 4-beiniger Buchenholzgestell.
- > Silla con estructura 4 patas en madera de haya. Carcasa en polipropileno tapizada.



386

- > Sgabello con telaio a 4 gambe in faggio. Seduta in polipropilene.
- > Barstool with beech wood frame, 4 legs. Polypropylene shell.
- > Tabouret avec chassis 4 pieds en hêtre. Coque en polypropylène.
- > Barhocker mit 4-beinigem Buchenholzgestell. Sitzfläche aus Polypropylen.
- > Taburete con estructura 4 patas en madera de haya. Carcasa en polipropileno.



386M

- > Sgabello con seduta in polipropilene, imbottita. Telaio 4 gambe in legno.
- > Barstool with beech wood frame, 4 legs. Upholstered polypropylene shell.
- > Tabouret avec chassis 4 pieds en hêtre. Coque en polypropylène rembourrée.
- > Barhocker mit Sitzfläche aus Polypropylen und Bezug auf Stoff. 4-beiniger Buchenholzgestell.
- > Taburete con estructura 4 patas en madera de haya. Carcasa en polipropileno tapizada.



577

- > Sedia con telaio 4 gambe tonde in faggio. Seduta in polipropilene.
- > Chair with beech wood frame, 4 rounded legs. Polypropylene shell.
- > Chaise avec châssis 4 pieds ronds en hêtre. Coque en polypropylène.
- > Stuhl mit Gestell aus 4 runden Buchenholzbeine. Sitzfläche aus Polypropylen.
- > Silla con estructura 4 patas redonda en madera de haya. Carcasa en polipropileno.



577M

- > Sedia con seduta in polipropilene, imbottita. Telaio 4 gambe tonde in faggio.
- > Chair with beech wood frame, 4 rounded legs. Upholstered polypropylene shell.
- > Chaise avec châssis 4 pieds ronds en hêtre. Coque en polypropylène rembourrée.
- > Stuhl mit Gestell aus 4 runden Buchenholzbeine. Sitzfläche aus Polypropylen und Bezug aus Stoff.
- > Silla con estructura 4 patas redonda en madera de haya. Carcasa en polipropileno tapizada.



393

- > Sgabello con seduta in polipropilene, telaio 4 gambe tonde in faggio.
- > Barstool with wooden frame, 4 round legs. Polypropylene shell.
- > Tabouret avec chassis 4 pieds ronds en hêtre. Coque en polypropylène.
- > Barhocker mit Sitzfläche aus Polypropylen. 4-beiniger Buchenholzgestell.
- > Taburete con estructura 4 patas redonda en madera de haya. Carcasa en polipropileno.



393M

- > Sgabello con seduta in polipropilene, imbottita. Telaio 4 gambe tonde in faggio.
- > Barstool with wooden frame, 4 round legs. Upholstered polypropylene shell.
- > Tabouret avec chassis 4 pieds ronds en hêtre. Coque en polypropylène rembourrée.
- > Barhocker mit Sitzfläche aus Polypropylen und Bezug auf Stoff. 4-beiniger Buchenholzgestell.
- > Taburete con estructura 4 patas redonda en madera de haya. Carcasa en polipropileno tapizada.



Peso / Weight / Poids / Gewicht / Peso **4,5 kg**

Imballo / Packaging / Emballage / Verpackung / Embalaje **0,28 m³**

Pezzi per scatola / Pieces per box / Pièces par carton / Stücke in einem Karton / Piezas por caja **2**



Peso / Weight / Poids / Gewicht / Peso **6,7 kg**

Imballo / Packaging / Emballage / Verpackung / Embalaje **0,24 m³**

Pezzi per scatola / Pieces per box / Pièces par carton / Stücke in einem Karton / Piezas por caja **1**

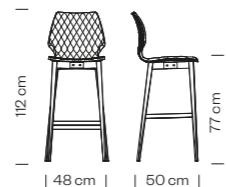

Peso / Weight / Poids / Gewicht / Peso **6,3 kg**

Imballo / Packaging / Emballage / Verpackung / Embalaje **0,35 m³**

Pezzi per scatola / Pieces per box / Pièces par carton / Stücke in einem Karton / Piezas por caja **1**

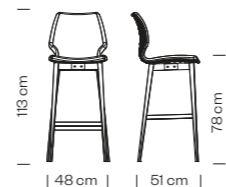

Peso / Weight / Poids / Gewicht / Peso **8,45 kg**

Imballo / Packaging / Emballage / Verpackung / Embalaje **0,35 m³**

Pezzi per scatola / Pieces per box / Pièces par carton / Stücke in einem Karton / Piezas por caja **1**



Peso / Weight / Poids / Gewicht / Peso **4,7 kg**

Imballo / Packaging / Emballage / Verpackung / Embalaje **0,30 m³**

Pezzi per scatola / Pieces per box / Pièces par carton / Stücke in einem Karton / Piezas por caja **2**



Peso / Weight / Poids / Gewicht / Peso **6,85 kg**

Imballo / Packaging / Emballage / Verpackung / Embalaje **0,24 m³**

Pezzi per scatola / Pieces per box / Pièces par carton / Stücke in einem Karton / Piezas por caja **1**

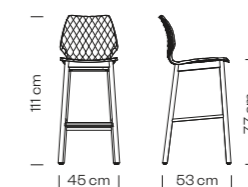

Peso / Weight / Poids / Gewicht / Peso **6,6 kg**

Imballo / Packaging / Emballage / Verpackung / Embalaje **0,35 m³**

Pezzi per scatola / Pieces per box / Pièces par carton / Stücke in einem Karton / Piezas por caja **1**

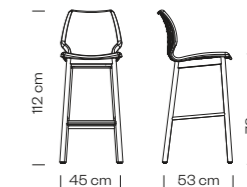

Peso / Weight / Poids / Gewicht / Peso **8,75 kg**

Imballo / Packaging / Emballage / Verpackung / Embalaje **0,35 m³**

Pezzi per scatola / Pieces per box / Pièces par carton / Stücke in einem Karton / Piezas por caja **1**





551

- > Sedia con telaio a 4 gambe in tubo acciaio, con braccioli. Seduta in polipropilene.
- > Chair with armrests and steel frame, 4 legs. Polypropylene shell.
- > Chaise avec châssis en acier 4 pieds et accoudoirs. Coque en polypropylène.
- > Armlehnstuhl mit 4-beinigem Stahlgestell. Sitzfläche aus Polypropylen.
- > Silla con estructura tubular 4 patas en acero con brazos, carcasa en polipropileno.



551M

- > Sedia con seduta in polipropilene, imbottita. Telaio a 4 gambe in tubo acciaio, con braccioli.
- > Chair with armrests and steel frame, 4 legs. Upholstered polypropylene shell.
- > Chaise avec châssis en acier 4 pieds et accoudoirs. Coque en polypropylène rembourrée.
- > Armlehnstuhl mit Sitzfläche aus Polypropylen und Bezug auf Stoff. 4-beinigem Stahlgestell.
- > Silla con estructura tubular 4 patas en acero con brazos, carcasa en polipropileno tapizada.



553

- > Sedia con telaio a traliccio in tondino acciaio. Seduta in polipropilene.
- > Chair with wire steel frame. Polypropylene shell.
- > Chaise avec châssis treillis en fil d'acier. Coque en polypropylène.
- > Stuhl mit Gittergestell aus Stahlstangen. Sitzfläche aus Polypropylen.
- > Silla con estructura enrejado en acero, carcasa en polipropileno.



553M

- > Sedia con seduta in polipropilene, imbottita. Telaio a traliccio in tondino acciaio.
- > Chair with wire steel frame. Upholstered polypropylene shell.
- > Chaise avec châssis treillis en fil d'acier. Coque en polypropylène rembourrée.
- > Stuhl mit Gittergestell aus Stahlstangen. Sitzfläche aus Polypropylen und Bezug aus Stoff.
- > Silla con estructura enrejado en acero, carcasa en polipropileno, tapizada.



603

- > Sedia con telaio a basamento centrale in acciaio, girevole. Seduta in polipropilene.
- > Swivel chair with central steel base and polypropylene shell.
- > Chaise avec pivotement central pivotant en acier. Coque en polypropylène.
- > Stuhl mit Untergestell und mittlerem Standfuss aus Stahl, drehbar. Sitzfläche aus Polypropylen.
- > Silla con estructura columna central en acero, giratoria. Carcasa en polipropileno.



603M

- > Sedia con seduta in polipropilene, imbottita. Telaio a basamento centrale in acciaio, girevole.
- > Swivel chair with central steel base. Upholstered polypropylene shell.
- > Chaise avec pivotement central pivotant en acier. Coque en polypropylène rembourrée.
- > Stuhl mit Untergestell und mittlerem Standfuss aus Stahl, drehbar. Sitzfläche aus Polypropylen und Bezug aus Stoff.
- > Silla con estructura columna central en acero, giratoria. Carcasa en polipropileno tapizada.



602

- > Sedia con telaio a 4 gambe tonde in faggio. Seduta in polipropilene.
- > Chair with beech wood frame, 4 rounded legs. Polypropylene shell.
- > Chaise avec châssis 4 pieds ronds en hêtre. Coque en polypropylène.
- > Stuhl mit Gestell aus 4 runden Buchenholzbeine. Sitzfläche aus Polypropylen.
- > Silla con estructura 4 patas redonda en madera de haya. Carcasa en polipropileno.



602M

- > Sedia con seduta in polipropilene, imbottita. Telaio 4 gambe tonde in faggio.
- > Chair with beech wood frame, 4 rounded legs. Upholstered polypropylene shell.
- > Chaise avec châssis 4 pieds ronds en hêtre. Coque en polypropylène rembourrée.
- > Stuhl mit Sitzfläche aus Stoff. Gestell aus 4 runden Buchenholzbeine.
- > Silla con estructura 4 patas redonda en madera de haya. Carcasa en polipropileno tapizada.

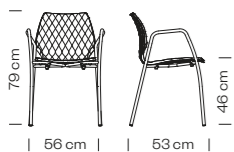

Peso / Weight / Poids / Gewicht / Peso **5,5 kg**

Imballo / Packaging / Emballage / Verpackung / Embalaje **0,39 m³**

Pezzi per scatola / Pieces per box / Pièces par carton / Stücke in einem Karton / Piezas por caja **4**

Impilabile / Stackable / Empilable / Stapelbar / Apilable **4**



Peso / Weight / Poids / Gewicht / Peso **7,65 kg**

Imballo / Packaging / Emballage / Verpackung / Embalaje **0,39 m³**

Pezzi per scatola / Pieces per box / Pièces par carton / Stücke in einem Karton / Piezas por caja **1**

Impilabile / Stackable / Empilable / Stapelbar / Apilable **1**



Peso / Weight / Poids / Gewicht / Peso **5 kg**

Imballo / Packaging / Emballage / Verpackung / Embalaje **0,30 m³**

Pezzi per scatola / Pieces per box / Pièces par carton / Stücke in einem Karton / Piezas por caja **2**

Impilabile / Stackable / Empilable / Stapelbar / Apilable **2**

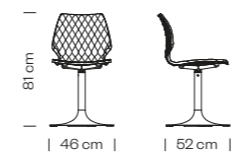

Peso / Weight / Poids / Gewicht / Peso **8,3 kg**

Imballo / Packaging / Emballage / Verpackung / Embalaje **0,24 m³**

Pezzi per scatola / Pieces per box / Pièces par carton / Stücke in einem Karton / Piezas por caja **1**

Impilabile / Stackable / Empilable / Stapelbar / Apilable **1**



Peso / Weight / Poids / Gewicht / Peso **10,4 kg**

Imballo / Packaging / Emballage / Verpackung / Embalaje **0,24 m³**

Pezzi per scatola / Pieces per box / Pièces par carton / Stücke in einem Karton / Piezas por caja **1**

Impilabile / Stackable / Empilable / Stapelbar / Apilable **1**



Peso / Weight / Poids / Gewicht / Peso **4,5 kg**

Imballo / Packaging / Emballage / Verpackung / Embalaje **0,33 m³**

Pezzi per scatola / Pieces per box / Pièces par carton / Stücke in einem Karton / Piezas por caja **2**

Impilabile / Stackable / Empilable / Stapelbar / Apilable **2**

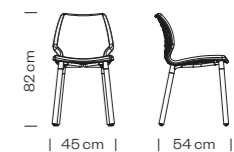

Peso / Weight / Poids / Gewicht / Peso **6,65 kg**

Imballo / Packaging / Emballage / Verpackung / Embalaje **0,24 m³**

Pezzi per scatola / Pieces per box / Pièces par carton / Stücke in einem Karton / Piezas por caja **1**

Impilabile / Stackable / Empilable / Stapelbar / Apilable **1**





552

- > Sedia con telaio a slitta in tondino acciaio. Seduta in polipropilene.
- > Chair with sled steel frame. Polypropylene shell.
- > Chaise avec châssis en fil d'acier pied luge. Coque en polypropylène.
- > Stuhl mit Kufengestell aus Stahlstangen. Sitzfläche aus Polypropylen.
- > Silla con estructura patín en acero, carcasa en polipropileno.



552M

- > Sedia con seduta in polipropilene, imbottita. Telaio a slitta in tondino acciaio.
- > Chair with sled steel frame, upholstered polypropylene shell.
- > Chaise avec châssis en fil d'acier pied luge. Coque en polypropylène rembourrée.
- > Stuhl mit Sitzfläche aus Polypropylen und Bezug aus Stoff. Kufengestell aus Stahlstangen.
- > Silla con estructura patín en acero, carcasa en polipropileno tapizada.



552-G

- > Sedia con telaio a slitta in tondino acciaio e sistema di aggancio. Seduta in polipropilene.
- > Chair with sled steel frame and linking device. Polypropylene shell.
- > Chaise avec châssis en fil d'acier pied luge et système d'accrochage. Coque en polypropylène.
- > Stuhl mit Kufengestell aus Stahlstangen und Verbindungssystem. Sitzfläche aus Polypropylen.
- > Silla con estructura patín en acero y sistema de enganche, carcasa en polipropileno.



552M-G

- > Sedia con seduta in polipropilene, imbottita. Telaio a slitta in tondino acciaio e sistema di aggancio.
- > Chair with sled steel frame and linking device. Upholstered polypropylene shell.
- > Chaise avec châssis en fil d'acier pied luge et système d'accrochage. Coque en polypropylène rembourrée.
- > Stuhl mit Sitzfläche aus Polypropylen und Bezug aus Stoff. Kufengestell aus Stahlstangen mit Verbindungssystem.
- > Silla con estructura patín en acero y sistema de enganche, carcasa en polipropileno tapizada.



552-T

- > Sedia con telaio a slitta in tondino acciaio, con tavoletta conferenza antipánico. Seduta in polipropilene.
- > Chair with steel sled frame with conference desk kit. Polypropylene shell.
- > Chaise avec châssis pied luge en fil d'acier équipée de tablette amovible. Coque en polypropylène.
- > Stuhl mit Kufengestell aus Stahlstangen. ausgelegt für Konferenzraumausstattung mit Schreibpult. Sitzfläche aus Polypropylen.
- > Silla con estructura patín en acero con tableta conferencia antipánico, carcasa en polipropileno.



552-GT

- > Sedia con telaio a slitta in tondino acciaio e sistema di aggancio, con tavoletta conferenza antipánico. Seduta in polipropilene.
- > Chair with steel sled frame and linking device with conference desk kit. Polypropylene shell.
- > Chaise avec châssis pied luge en fil d'acier équipée de tablette amovible et système d'accrochage.
- > Stuhl mit Kufengestell aus Stahlstangen ausgelegt für Konferenzraumausstattung mit Verbindungssystem und Schreibpult. Sitzfläche aus Polypropylen.
- > Silla con estructura patín en acero y sistema de enganche, con tableta conferencia antipánico. Carcasa en polipropileno.



391

- > Sgabello con telaio a slitta in acciaio, seduta in polipropilene.
- > Barstool with steel sled frame, polypropylene shell.
- > Tabouret avec chassis pied luge en fil d'acier. Coque en polypropylène.
- > Barhocker mit Kufengestell aus Stahl. Sitzfläche aus Polypropylen.
- > Taburete con estructura patín en acero, carcasa en polipropileno.



391M

- > Sgabello con seduta in polipropilene, imbottita. Telaio a slitta in tondino acciaio.
- > Barstool with steel sled frame, upholstered polypropylene shell.
- > Tabouret avec chassis pied luge en fil d'acier. Coque en polypropylène rembourrée.
- > Barhocker mit Sitzfläche aus Polypropylen und Bezug auf Stoff. Kufengestell aus Stahl.
- > Taburete con estructura patín en acero, carcasa en polipropileno tapizada.



Peso / Weight / Poids / Gewicht / Peso **6,3 kg**

Imballo / Packaging / Emballage / Verpackung / Embalaje **0,39 m³**

Pezzi per scatola / Pieces per box / Pièces par carton / Stücke in einem Karton / Piezas por caja **4**

Impilabile / Stackable / Empilable / Stapelbar / Apilable **4**



Peso / Weight / Poids / Gewicht / Peso **8,4 kg**

Imballo / Packaging / Emballage / Verpackung / Embalaje **0,34 m³**

Pezzi per scatola / Pieces per box / Pièces par carton / Stücke in einem Karton / Piezas por caja **1**



Peso / Weight / Poids / Gewicht / Peso **6,4 kg**

Imballo / Packaging / Emballage / Verpackung / Embalaje **0,39 m³**

Pezzi per scatola / Pieces per box / Pièces par carton / Stücke in einem Karton / Piezas por caja **4**

Impilabile / Stackable / Empilable / Stapelbar / Apilable **4**

Sistema di aggancio / Linking device / Système d'accrochage / Verbindungssystem / Sistema de enganche



Peso / Weight / Poids / Gewicht / Peso **8,5 kg**

Imballo / Packaging / Emballage / Verpackung / Embalaje **0,34 m³**

Pezzi per scatola / Pieces per box / Pièces par carton / Stücke in einem Karton / Piezas por caja **1**

Impilabile / Stackable / Empilable / Stapelbar / Apilable **4**

Sistema di aggancio / Linking device / Système d'accrochage / Verbindungssystem / Sistema de enganche



Peso / Weight / Poids / Gewicht / Peso **7,8 kg**

Imballo / Packaging / Emballage / Verpackung / Embalaje **0,39 m³**

Pezzi per scatola / Pieces per box / Pièces par carton / Stücke in einem Karton / Piezas por caja **4**

Impilabile / Stackable / Empilable / Stapelbar / Apilable **4**



Peso / Weight / Poids / Gewicht / Peso **7,9 kg**

Imballo / Packaging / Emballage / Verpackung / Embalaje **0,39 m³**

Pezzi per scatola / Pieces per box / Pièces par carton / Stücke in einem Karton / Piezas por caja **4**

Impilabile / Stackable / Empilable / Stapelbar / Apilable **4**

Sistema di aggancio / Linking device / Système d'accrochage / Verbindungssystem / Sistema de enganche

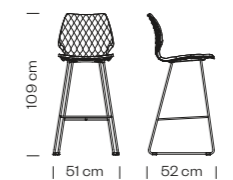

Peso / Weight / Poids / Gewicht / Peso **5,1 kg**

Imballo / Packaging / Emballage / Verpackung / Embalaje **0,35 m³**

Pezzi per scatola / Pieces per box / Pièces par carton / Stücke in einem Karton / Piezas por caja **1**

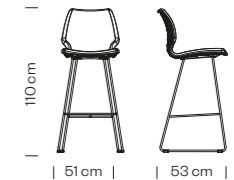

Peso / Weight / Poids / Gewicht / Peso **7,25 kg**

Imballo / Packaging / Emballage / Verpackung / Embalaje **0,35 m³**

Pezzi per scatola / Pieces per box / Pièces par carton / Stücke in einem Karton / Piezas por caja **1**



220

- > Sistema sedute su barra a 2 posti con pianetto, telaio in acciaio. Seduta in polipropilene.
- > Seating system on bar, 2 seats with shelf; steel frame, polypropylene seat.
- > Système d'assise sur poutre. Assise en polypropylène, châssis en acier. Version 2 places + tablette.
- > Sitzsystem auf Balken, 2 Sitzplätze mit Ablagefläche. Gestell aus Stahl. Sitzfläche aus Polypropylen.
- > Sistema de asientos en barra, 2 asientos y mesa, estructura en acero. Carcasa en polipropileno.



221

- > Sistema sedute su barra a 3 posti, telaio in acciaio. Seduta in polipropilene.
- > Seating system on bar, 3 seats; steel frame, polypropylene seat.
- > Système d'assise sur poutre. Assise en polypropylène, châssis en acier. Version 3 places.
- > Sitzsystem auf Balken, 3 Sitzplätze. Gestell aus Stahl. Sitzfläche aus Polypropylen.
- > Sistema de asientos en barra, 3 asientos, estructura en acero. Carcasa en polipropileno.



222

- > Sistema sedute su barra a 3 posti con pianetto, telaio in acciaio. Seduta in polipropilene.
- > Seating system on bar, 3 seats with shelf; steel frame, polypropylene seat.
- > Système d'assise sur poutre. Assise en polypropylène, châssis en acier. Version 3 places + tablette.
- > Sitzsystem auf Balken, 3 Sitzplätze mit Ablagefläche. Gestell aus Stahl. Sitzfläche aus Polypropylen.
- > Sistema de asientos en barra, 3 asientos y mesa, estructura en acero. Carcasa en polipropileno.



223

- > Sistema sedute su barra a 4 posti, telaio in acciaio. Seduta in polipropilene.
- > Seating system on bar, 4 seats; steel frame, polypropylene seat.
- > Système d'assise sur poutre. Assise en polypropylène, châssis en acier. Version 4 places.
- > Sitzsystem auf Balken, 4 Sitzplätze. Gestell aus Stahl. Sitzfläche aus Polypropylen.
- > Sistema de asientos en barra, 4 asientos, estructura en acero. Carcasa en polipropileno.

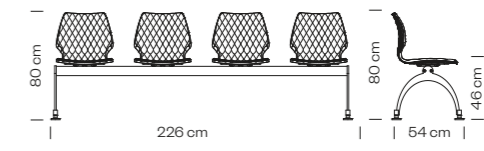
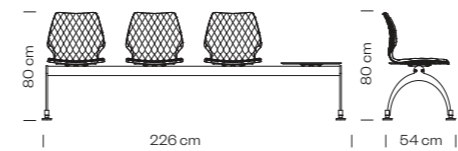
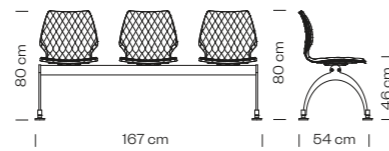
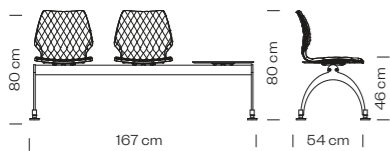

Peso / Weight / Poids / Gewicht / Peso **24,6 kg**

Imballo / Packaging / Emballage / Verpackung / Embalaje **0,89 m³**

Pezzi per scatola / Pieces per box / Pièces par carton / Stücke in einem Karton / Piezas por caja **1**

Peso / Weight / Poids / Gewicht / Peso **23 kg**

Imballo / Packaging / Emballage / Verpackung / Embalaje **0,89 m³**

Pezzi per scatola / Pieces per box / Pièces par carton / Stücke in einem Karton / Piezas por caja **1**

Peso / Weight / Poids / Gewicht / Peso **29,1 kg**

Imballo / Packaging / Emballage / Verpackung / Embalaje **1,25 m³**

Pezzi per scatola / Pieces per box / Pièces par carton / Stücke in einem Karton / Piezas por caja **1**

Peso / Weight / Poids / Gewicht / Peso **27,5 kg**

Imballo / Packaging / Emballage / Verpackung / Embalaje **1,25 m³**

Pezzi per scatola / Pieces per box / Pièces par carton / Stücke in einem Karton / Piezas por caja **1**



558-DP

- > Sedia con telaio a 5 razze in alluminio, girevole. Seduta in polipropilene.
- > Swivel chair with 5 ways aluminium frame. Polypropylene shell.
- > Chaise pivotant avec châssis en aluminium 5 branches avec patins. Coque en polypropylène.
- > Stuhl mit Aluminiumgestell, drehbar und mit 5-armigem Fusskreuz. Sitzfläche aus Polypropylen.
- > Silla con estructura 5 radios en aluminio, giratoria, carcasa en polipropileno.



558M-DP

- > Sedia con seduta in polipropilene, imbottita. Telaio a 5 razze in alluminio, girevole.
- > Swivel chair with 5 ways, aluminium frame. Upholstered polypropylene shell.
- > Chaise pivotant avec châssis en aluminium 5 branches avec patins. Coque en polypropylène rembourrée.
- > Stuhl mit Sitzfläche aus Polypropylen und Bezug aus Stoff. Aluminium Gestell mit 5-armigem Fusskreuz.
- > Silla con estructura 5 radios en aluminio, giratoria, carcasa en polipropileno tapizada.



558-DR

- > Sedia con telaio a 5 razze in alluminio, girevole, su ruote. Seduta in polipropilene.
- > Swivel chair with 5 ways on castors, aluminium frame. Polypropylene shell.
- > Chaise pivotant avec châssis en aluminium 5 branches avec roulettes. Coque en polypropylène.
- > Stuhl mit Aluminiumgestell, drehbar und mit 5-armigem Fusskreuz und Rollen. Sitzfläche aus Polypropylen.
- > Silla con estructura 5 radios en aluminio, giratoria, con ruedas, carcasa en polipropileno.



558M-DR

- > Sedia con seduta in polipropilene, imbottita. Telaio a 5 razze in alluminio, girevole, su ruote.
- > Swivel chair with 5 ways on castors, aluminium frame. Upholstered polypropylene shell.
- > Chaise pivotant avec châssis en aluminium 5 branches avec roulettes. Coque en polypropylène rembourrée.
- > Stuhl mit Sitzfläche aus Polypropylen und Bezug aus Stoff. Aluminium Gestell mit 5-armigem Fusskreuz und Rollen.
- > Silla con estructura 5 radios en aluminio, giratoria, con ruedas, carcasa en polipropileno tapizada.



544

- > Sedia con telaio da mensa in tubo acciaio e seduta in polipropilene.
- > Chair with "C" steel frame and polypropylene shell.
- > Chaise avec châssis en acier appui sur table et coque en polypropylène.
- > Stuhl mit Gestell mit vorderem, offenem Fußbügel und Sitzfläche aus Polypropylen.
- > Silla con estructura de comedor en acero. Carcasa en polipropileno.



565

- > Sedia con telaio da mensa in tubo acciaio. Seduta in polipropilene.
- > Chair with "C" steel frame and polypropylene shell.
- > Chaise avec châssis en acier appui sur table et coque en polypropylène.
- > Stuhl mit Gestell mit vorderem, offenem Fußbügel und Sitzfläche aus Polypropylen.
- > Silla con estructura de comedor en acero. Carcasa en polipropileno.



536

- > Carrello per 10 Uni 550 / 14 Uni 552
- > Trolley for 10 Uni 550 / 14 Uni 552
- > Chariot pour 10 Uni 550 / 14 Uni 552
- > Transportwagen für 10 Uni 550 / 14 Uni 552
- > Carrito por 10 Uni 550 / 14 Uni 552

TE

- > Finiture seduta (vedi p. 359)
- > Seat finishes (see p. 359)
- > Finitions de l'assise (voir p. 359)
- > Sitzfertigung (sehen S. 359)
- > Acabados asiento (ver p. 359)

PP

- > Finiture seduta
- > Seat finishes
- > Finitions de l'assise
- > Sitzfertigung
- > Acabados asiento



Peso / Weight / Poids / Gewicht / Peso **6,9 kg**

Imballo / Packaging / Emballage / Verpackung / Embalaje **0,50 m³**

Pezzi per scatola / Pieces per box / Pièces par carton / Stücke in einem Karton / Piezas por caja **2**



Peso / Weight / Poids / Gewicht / Peso **8,8 kg**

Imballo / Packaging / Emballage / Verpackung / Embalaje **0,39 m³**

Pezzi per scatola / Pieces per box / Pièces par carton / Stücke in einem Karton / Piezas por caja **1**



Peso / Weight / Poids / Gewicht / Peso **7 kg**

Imballo / Packaging / Emballage / Verpackung / Embalaje **0,50 m³**

Pezzi per scatola / Pieces per box / Pièces par carton / Stücke in einem Karton / Piezas por caja **2**



Peso / Weight / Poids / Gewicht / Peso **8,8 kg**

Imballo / Packaging / Emballage / Verpackung / Embalaje **0,39 m³**

Pezzi per scatola / Pieces per box / Pièces par carton / Stücke in einem Karton / Piezas por caja **1**

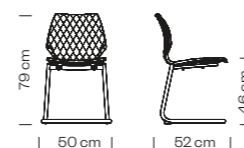

Peso / Weight / Poids / Gewicht / Peso **6,1 kg**

Imballo / Packaging / Emballage / Verpackung / Embalaje **0,35 m³**

Pezzi per scatola / Pieces per box / Pièces par carton / Stücke in einem Karton / Piezas por caja **4**

Impilabile / Stackable / Empilable / Stapelbar / Apilable **4**



Peso / Weight / Poids / Gewicht / Peso **5,2 kg**

Imballo / Packaging / Emballage / Verpackung / Embalaje **0,28 m³**

Pezzi per scatola / Pieces per box / Pièces par carton / Stücke in einem Karton / Piezas por caja **2**

AC

- > Finiture telaio (vedi p. 395)
- > Frame finishes (see p. 395)
- > Finitions piètement (voir p. 395)
- > Gestell fertigungen (sehen S. 395)
- > Acabados estructura (ver p. 395)

AL PSH

- > Finiture telaio (vedi p. 398)
- > Frame finishes (see p. 398)
- > Finitions piètement (voir p. 398)
- > Gestell fertigungen (sehen S. 398)
- > Acabados estructura (ver p. 398)

LE

- > Finiture telaio
- > Frame finishes
- > Finitions piètement
- > Gestell fertigungen
- > Acabados estructura

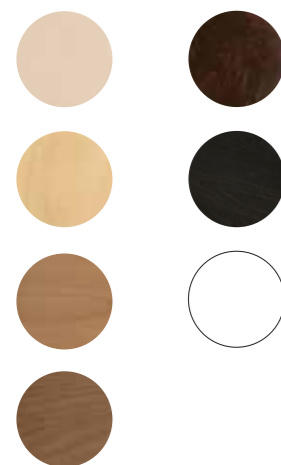

AL VR

- > Finiture telaio
- > Frame finishes
- > Finitions piètement
- > Gestell fertigungen
- > Acabados estructura





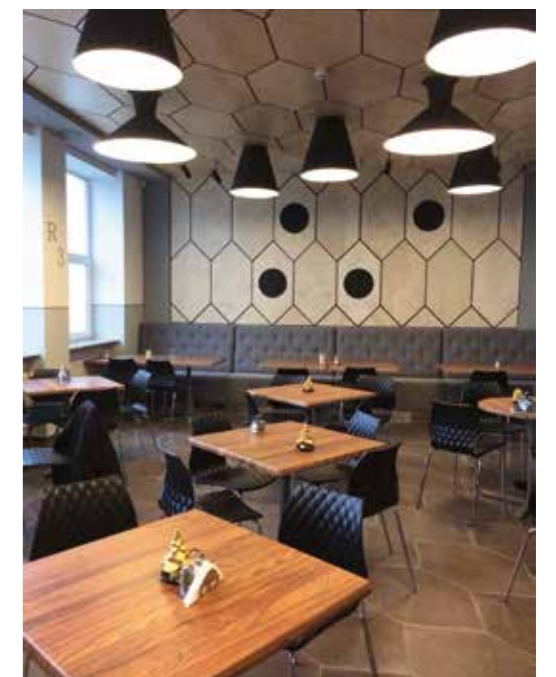



agatha

design
rdm, 2011



218



047

- > Poltroncina con telaio a 4 gambe in tubo acciaio. Sedile e schienale in tessuto.
- > Armchair with 4 legs steel frame. Upholstered seat and back.
- > Fauteuil avec châssis 4 pieds en acier. Assise et dossier en tissu.
- > Armlehnstuhl mit 4-beinigem Stahlgestell. Gepolsterte Sitzfläche und Rückenlehne.
- > Sillón con estructura tubular 4 patas en acero. Asiento y respaldo tapizados.

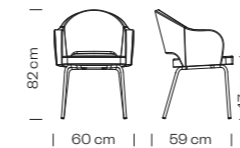

Peso / Weight / Poids / Gewicht / Peso **9,3 kg**

Imballo / Packaging / Emballage / Verpackung / Embalaje **0,34 m³**

Pezzi per scatola / Pieces per box / Pièces par carton / Stücke in einem Karton / Piezas por caja **1**



048

- > Poltroncina con telaio a 4 razze in tubo acciaio. Sedile e schienale in tessuto.
- > Armchair with 4 ways steel frame. Upholstered seat and back.
- > Fauteuil avec châssis 4 branches en acier. Assise et dossier en tissu.
- > Armlehnstuhl mit 4-armigem Fusskreuz aus Stahl. Gepolsterte Sitzfläche und Rückenlehne.
- > Sillón con estructura tubular 4 radios en acero. Asiento y respaldo tapizados.

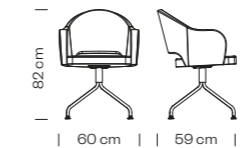

Peso / Weight / Poids / Gewicht / Peso **9,8 kg**

Imballo / Packaging / Emballage / Verpackung / Embalaje **0,34 m³**

Pezzi per scatola / Pieces per box / Pièces par carton / Stücke in einem Karton / Piezas por caja **1**



572

- > Poltroncina con telaio a 4 gambe in faggio. Sedile e schienale in tessuto.
- > Armchair with beech wood frame. 4 legs. Upholstered seat and back.
- > Fauteuil avec châssis 4 pieds en hêtre. Assise et dossier en tissu.
- > Armlehnstuhl mit 4-beinigem Buchenholzgestell. Gepolsterte Sitzfläche und Rückenlehne.
- > Sillón con estructura 4 patas en madera de haya. Asiento y respaldo tapizados.

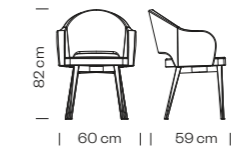

Peso / Weight / Poids / Gewicht / Peso **9,7 kg**

Imballo / Packaging / Emballage / Verpackung / Embalaje **0,34 m³**

Pezzi per scatola / Pieces per box / Pièces par carton / Stücke in einem Karton / Piezas por caja **1**

219



046-DP

- > Poltroncina con telaio in alluminio a 5 razze, girevole. Sedile e schienale in tessuto.
- > Swivel armchair with 5 ways aluminium frame. Upholstered seat and back.
- > Fauteuil pivotant avec châssis en aluminium 5 branches avec patins. Assise et dossier en tissu.
- > Armlehnstuhl mit Aluminiumgestell, drehbar und mit 5-armigem Fusskreuz. Gepolsterte Sitzfläche und Rückenlehne.
- > Sillón con estructura 5 radios en aluminio, giratoria. Asiento y respaldo tapizados.



046-DR

- > Poltroncina con telaio in alluminio a 5 razze, girevole, su ruote. Sedile e schienale in tessuto.
- > Swivel armchair with 5 ways on castors, aluminium frame. Upholstered seat and back.
- > Fauteuil pivotant avec châssis en aluminium 5 branches avec roulettes. Assise et dossier en tissu.
- > Armlehnstuhl mit Aluminiumgestell, drehbar und mit 5-armigem Fusskreuz und Rollen. Gepolsterte Sitzfläche und Rückenlehne.
- > Sillón con estructura 5 radios en aluminio, giratoria, con ruedas. Asiento y respaldo tapizados.



383

- > Sgabello con telaio a basamento centrale girevole in acciaio. Sedile e schienale in tessuto.
- > Swivel stool with central steel base frame. Upholstered seat and back.
- > Tabouret pivotant avec piétement central en acier. Assise et dossier en tissu.
- > Barhocker mit Gestell auf zentralem, drehbarem Standfuss aus Stahl. Gepolsterte Sitzfläche und Rückenlehne.
- > Taburete con estructura columna central en acero, giratoria. Asiento y respaldo tapizados.



384

- > Sgabello con telaio a 4 gambe in tubo acciaio. Sedile e schienale in tessuto.
- > Barstool with 4 legs steel frame. Upholstered seat and back.
- > Tabouret avec châssis 4 pieds en acier. Assise et dossier en tissu.
- > Barhocker mit 4-beinigem Stahlgestell. Gepolsterte Sitzfläche und Rückenlehne.
- > Taburete con estructura tubular 4 patas en acero. Asiento y respaldo tapizados.

TE

- > Finiture seduta (vedi p. 359)
- > Seat finishes (see p. 359)
- > Finitions de l'assise (voir p. 359)
- > Sitzfertigung (sehen S. 359)
- > Acabados asiento (ver p. 359)

AC

- > Finiture telaio (vedi p. 395)
- > Frame finishes (see p. 395)
- > Finitions piétement (voir p. 395)
- > Gestell fertigungen (sehen S. 395)
- > Acabados estructura (ver p. 395)

AL PSH

- > Finiture telaio (vedi p. 398)
- > Frame finishes (see p. 398)
- > Finitions piétement (voir p. 398)
- > Gestell fertigungen (sehen S. 398)
- > Acabados estructura (ver p. 398)



LE

- > Finiture telaio
- > Frame finishes
- > Finitions piétement
- > Gestell fertigungen
- > Acabados estructura

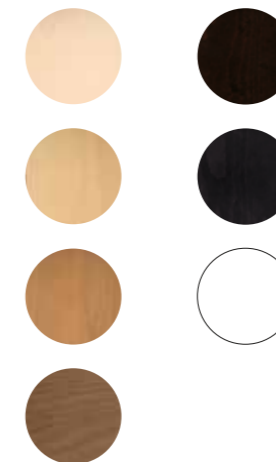

AL VR

- > Finiture telaio
- > Frame finishes
- > Finitions piétement
- > Gestell fertigungen
- > Acabados estructura



360°

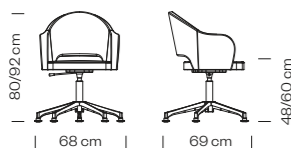

Peso / Weight / Poids / Gewicht / Peso **11,8 kg**

Imballo / Packaging / Emballage / Verpackung / Embalaje **0,50 m³**

Pezzi per scatola / Pieces per box / Pièces par carton / Stücke in einem Karton / Piezas por caja **1**

360°

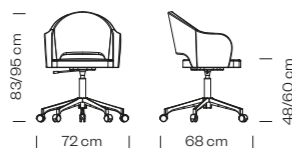

Peso / Weight / Poids / Gewicht / Peso **11,8 kg**

Imballo / Packaging / Emballage / Verpackung / Embalaje **0,50 m³**

Pezzi per scatola / Pieces per box / Pièces par carton / Stücke in einem Karton / Piezas por caja **1**

360°

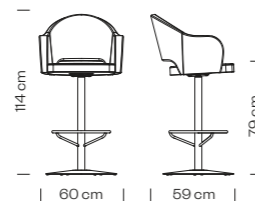

Peso / Weight / Poids / Gewicht / Peso **21,5 kg**

Imballo / Packaging / Emballage / Verpackung / Embalaje **0,44 m³**

Pezzi per scatola / Pieces per box / Pièces par carton / Stücke in einem Karton / Piezas por caja **1**

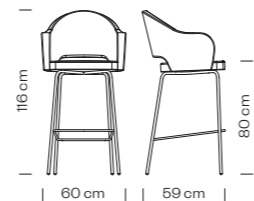

Peso / Weight / Poids / Gewicht / Peso **9,6 kg**

Imballo / Packaging / Emballage / Verpackung / Embalaje **0,44 m³**

Pezzi per scatola / Pieces per box / Pièces par carton / Stücke in einem Karton / Piezas por caja **1**



duo

design
Franco Bertoli & Max Pajetta, 2010



140

- > Sedia con telaio a slitta in tondino acciaio. Sedile e schienale in faggio e/o tessuto.
- > Chair with sled steel frame, beech wood and/or upholstered seat and back.
- > Chaise avec châssis en fil d'acier, pied luge, assise et dossier en bois ou en tissu.
- > Stuhl mit Kufengestell aus Stahl. Sitzfläche und Rückenlehne aus Buchenholz und/oder mit Bezug aus Stoff.
- > Silla con estructura patin en acero. Asiento y respaldo en madera de haya y/o tapizados.

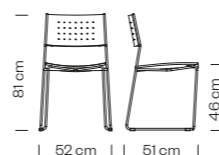

Peso / Weight / Poids / Gewicht / Peso **6,6 kg**

Imballo / Packaging / Emballage / Verpackung / Embalaje **0,33 m³**

Pezzi per scatola / Pieces per box / Pièces par carton / Stücke in einem Karton / Piezas por caja **4**

Impilabile / Stackable / Empilable / Stapelbar / Apilable **4**

140-G

- > Sedia con telaio a slitta in tondino acciaio e sistema aggancio. Sedile e schienale in legno e/o tessuto.
- > Chair with sled steel frame with linking device, beech wood and/or upholstered seat and back.
- > Chaise avec châssis luge en fil d'acier et système d'accrochage, assise et dossier en bois ou en tissu.
- > Stuhl mit Kufengestell aus Stahl und Verbindungssystem. Sitzfläche und Rückenlehne aus Buchenholz und/oder mit Bezug aus Stoff.
- > Silla con estructura patin en acero y sistema de enganche. Asiento y respaldo en madera de haya y/o tapizados.

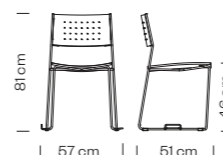

Peso / Weight / Poids / Gewicht / Peso **6,7 kg**

Imballo / Packaging / Emballage / Verpackung / Embalaje **0,33 m³**

Pezzi per scatola / Pieces per box / Pièces par carton / Stücke in einem Karton / Piezas por caja **4**

Impilabile / Stackable / Empilable / Stapelbar / Apilable **4**

Sistema di aggancio / Linking device / Système d'accrochage / Verbindungssystem / Sistema de enganche



TE

- > Finiture seduta (vedi p. 359)
- > Seat finishes (see p. 359)
- > Finitions de l'assise (voir p. 359)
- > Sitzfertigung (sehen S. 359)
- > Acabados asiento (ver p. 359)

AC

- > Finiture telaio (vedi p. 395)
- > Frame finishes (see p. 395)
- > Finitions piètement (voir p. 395)
- > Gestell fertigungen (sehen S. 395)
- > Acabados estructura (ver p. 395)

LE

- > Finiture seduta
- > Seat finishes
- > Finitions de l'assise
- > Sitzfertigung
- > Acabados asiento

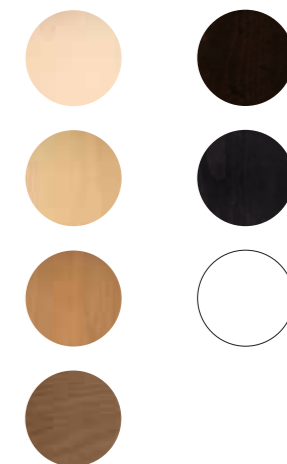

punto

design
Francesco Geraci, 2010



226



190

- > Sedia con telaio a 4 gambe in faggio. Sedile e schienale in tessuto.
- > Chair with beech wood frame, 4 legs. Upholstered seat and back.
- > Chaise avec châssis 4 pieds en hêtre, assise et dossier en tissu.
- > Stuhl mit 4-beinigem Buchenholzgestell. Gepolsterte Sitzfläche und Rückenlehne.
- > Silla con estructura 4 patas en madera de haya. Asiento y respaldo tapizados.

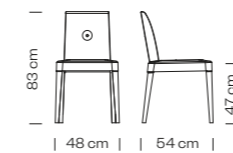

Peso / Weight / Poids / Gewicht / Peso **6 kg**

Imballo / Packaging / Emballage / Verpackung / Embalaje **0,39 m³**

Pezzi per scatola / Pieces per box / Pièces par carton / Stücke in einem Karton / Piezas por caja **2**



191

- > Poltroncina a 4 gambe in faggio. Sedile e schienale rivestiti.
- > Armchair with beech wood frame, 4 legs. Upholstered seat and back.
- > Fauteuil avec châssis 4 pieds en hêtre, assise et dossier en tissu.
- > Stuhl mit 4-beinigem Buchenholzgestell. Gepolsterte Sitzfläche, Rückenlehne und Armlehnen.
- > Silla con estructura 4 patas en madera de haya. Asiento y respaldo tapizados.

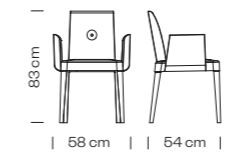

Peso / Weight / Poids / Gewicht / Peso **8 kg**

Imballo / Packaging / Emballage / Verpackung / Embalaje **0,34 m³**

Pezzi per scatola / Pieces per box / Pièces par carton / Stücke in einem Karton / Piezas por caja **1**



390

- > Sgabello con telaio a 4 gambe in faggio. Sedile e schienale in tessuto.
- > Barstool with beech wood frame, 4 legs. Upholstered seat and back.
- > Tabouret avec châssis 4 pieds en hêtre, assise et dossier en tissu.
- > Barhocker mit 4-beinigem Buchenholzgestell. Gepolsterte Sitzfläche und Rückenlehne.
- > Taburete con estructura 4 patas en madera de haya. Asiento y respaldo tapizados.

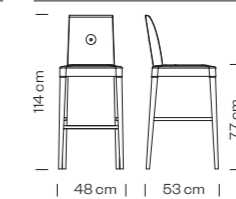

Peso / Weight / Poids / Gewicht / Peso **8 kg**

Imballo / Packaging / Emballage / Verpackung / Embalaje **0,35 m³**

Pezzi per scatola / Pieces per box / Pièces par carton / Stücke in einem Karton / Piezas por caja **1**



227

- > Sistema sedute multiple. Seduta lineare con telaio a 4 gambe in faggio. Sedile e schienale in tessuto. Modulo lineare.
- > Modular seating system, linear seating with beech wood frame, 4 legs. Upholstered seat and back. Linear module.
- > Banquettes multiples. Canapé, avec assise et dossier rembourrés, revêtement en tissu, châssis en hêtre. Module linéaire.
- > System aus mehreren Sitzmöbeln. Lineares Modul mit 4-beinigem Buchenholzgestell. Gepolsterte Sitzfläche und Rückenlehne.
- > Sistema de asientos múltiples. Asiento y respaldo tapizados. Estructura 4 patas en madera de haya. Módulo lineal.

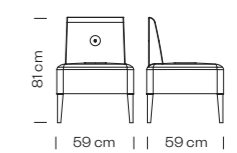

Peso / Weight / Poids / Gewicht / Peso **9 kg**

Imballo / Packaging / Emballage / Verpackung / Embalaje **0,34 m³**

Pezzi per scatola / Pieces per box / Pièces par carton / Stücke in einem Karton / Piezas por caja **1**

227



228

- > Sistema sedute multiple. Seduta angolare con telaio a 4 gambe in faggio. Sedile e schienale in tessuto. Modulo angolare.
- > Modular seating system, linear seating with beech wood frame, 4 legs. Upholstered seat and back. Angular module.
- > Banquettes multiples. Canapé, avec assise rembourrée, revêtement en tissu, châssis en hêtre. Module d'angle.
- > System aus mehreren Sitzmöbeln. Eckiges Modul mit 4-beinigem Buchenholzgestell. Gepolsterte Sitzfläche und Rückenlehne.
- > Sistema de asientos múltiples. Asiento y respaldo tapizados. Estructura 4 patas en madera de haya. Módulo de esquina.

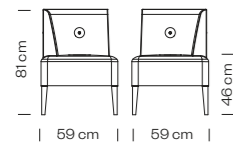

Peso / Weight / Poids / Gewicht / Peso **13 kg**

Imballo / Packaging / Emballage / Verpackung / Embalaje **0,34 m³**

Pezzi per scatola / Pieces per box / Pièces par carton / Stücke in einem Karton / Piezas por caja **1**



229

- > Sistema sedute multiple. Pouf con telaio a 4 gambe in faggio. Sedile in tessuto. Modulo pouf.
- > Modular seating system, linear seating with beech wood frame, 4 legs. Upholstered seat. Pouf module.
- > Banquettes multiples. Pouf, avec assise rembourrée, revêtement en tissu, châssis en hêtre.
- > System aus mehreren Sitzmöbeln. Hocker Modul mit 4-beinigem Buchenholzgestell. Gepolsterte Sitzfläche.
- > Sistema de asientos múltiples. Asiento tapizados. Estructura 4 patas en madera de haya. Módulo pouf.

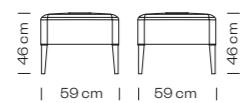

Peso / Weight / Poids / Gewicht / Peso **6 kg**

Imballo / Packaging / Emballage / Verpackung / Embalaje **0,34 m³**

Pezzi per scatola / Pieces per box / Pièces par carton / Stücke in einem Karton / Piezas por caja **2**

TE

- > Finiture seduta (vedi p. 359)
- > Seat finishes (see p. 359)
- > Finitions de l'assise (voir p. 359)
- > Sitzfertigung (sehen S. 359)
- > Acabados asiento (ver p. 359)

LE

- > Finiture telaio
- > Frame finishes
- > Finitions piètement
- > Gestell fertigungen
- > Acabados estructura

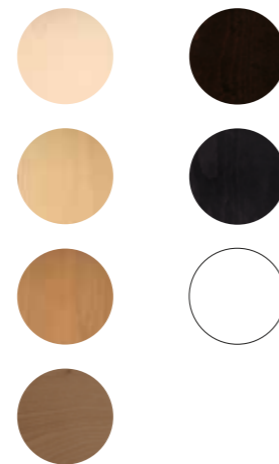

abaco

design
rdm, 2010



230



750

- > Sistema sedute multiple. Sedile e schienale imbottiti. Telaio in tubo acciaio. Modulo lineare L 60 cm.
- > Modular seating system. Upholstered seat and back. Steel frame. Linear module L 60 cm.
- > Système d'assises multiples. Assise et dossier rembourrés. Châssis en acier. Element linéaire de 60 cm.
- > System aus mehreren Sitzmöbeln. Gepolsterte Sitzfläche und Rückenlehne. Gestell aus Stahlrohren. Lineares Modul mit einer Länge von 60 cm.
- > Sistema de asientos múltiples. Asiento y respaldo tapizados. Estructura tubular en acero. Módulo lineal L 60 cm.

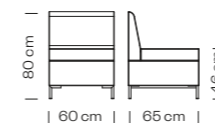

Peso / Weight / Poids / Gewicht / Peso **21 kg**

Imballo / Packaging / Emballage / Verpackung / Embalaje **0,35 m³**

Pezzi per scatola / Pieces per box / Pièces par carton / Stücke in einem Karton / Piezas por caja **1**



751

- > Sistema sedute multiple. Sedile e schienale imbottiti. Telaio in tubo acciaio. Modulo lineare L 120 cm.
- > Modular seating system. Upholstered seat and back. Steel frame. Linear module L 120 cm.
- > Système d'assises multiples. Assise et dossier rembourrés. Châssis en acier. Element linéaire de 120 cm.
- > System aus mehreren Sitzmöbeln. Gepolsterte Sitzfläche und Rückenlehne. Gestell aus Stahlrohren. Lineares Modul mit einer Länge von 120 cm.
- > Sistema de asientos múltiples. Asiento y respaldo tapizados. Estructura tubular en acero. Módulo lineal L 120 cm.

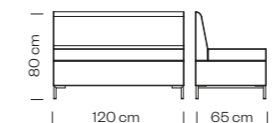

Peso / Weight / Poids / Gewicht / Peso **44 kg**

Imballo / Packaging / Emballage / Verpackung / Embalaje **0,73 m³**

Pezzi per scatola / Pieces per box / Pièces par carton / Stücke in einem Karton / Piezas por caja **1**



752

- > Sistema sedute multiple. Sedile e schienale imbottiti. Telaio in tubo acciaio. Modulo angolare.
- > Modular seating system. Upholstered seat and back. Steel frame. Corner module.
- > Système d'assises multiples. Assise et dossier rembourrés. Châssis en acier. Element d'angle.
- > System aus mehreren Sitzmöbeln. Gepolsterte Sitzfläche und Rückenlehne. Gestell aus Stahlrohren. Eckmodul.
- > Sistema de asientos múltiples. Asiento y respaldo tapizados. Estructura tubular en acero. Módulo de esquina.

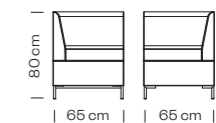

Peso / Weight / Poids / Gewicht / Peso **25 kg**

Imballo / Packaging / Emballage / Verpackung / Embalaje **0,38 m³**

Pezzi per scatola / Pieces per box / Pièces par carton / Stücke in einem Karton / Piezas por caja **1**

231



753

- > Sistema sedute multiple. Sedile imbottito. Telaio in tubo acciaio. Modulo pouf L 60 cm.
- > Modular seating system. Upholstered seat. Steel frame. Pouf module L 60 cm.
- > Système d'assises multiples. Assise rembourrée. Châssis en acier. Element pouf de 60 cm.
- > System aus mehreren Sitzmöbeln. Gepolsterte Sitzfläche. Gestell aus Stahlrohren. Hocker mit einer Länge von 60 cm.
- > Sistema de asientos múltiples. Asiento tapizado. Estructura tubular en acero. Módulo pouf L 60 cm.



754

- > Sistema sedute multiple. Sedile imbottito. Telaio in tubo acciaio. Modulo pouf L 120 cm.
- > Modular seating system. Upholstered seat. Steel frame. Pouf module L 120 cm.
- > Système d'assises multiples. Assise rembourrée. Châssis en acier. Element pouf de 120 cm.
- > System aus mehreren Sitzmöbeln. Gepolsterte Sitzfläche. Gestell aus Stahlrohren. Hocker mit einer Länge von 120 cm.
- > Sistema de asientos múltiples. Asiento tapizado. Estructura tubular en acero. Módulo pouf L 120 cm.



755

- > Sistema sedute multiple. Rivestimento a parete in tessuto. Modulo lineare L 60 cm.
- > Modular seating system. Upholstered wall panel. Linear module L 60 cm.
- > Système d'assises multiples. Revêtement mural en tissu. Element lineaire de 60 cm.
- > System aus mehreren Sitzmöbeln. Gepolsterte Wandverkleidung. Lineares Modul mit Länge von 60 cm.
- > Sistema de asientos múltiples. Revestimiento mural en tejido. Módulo lineal L 60 cm.



756

- > Sistema sedute multiple. Rivestimento a parete in tessuto. Modulo lineare L 120 cm.
- > Modular seating system. Upholstered wall panel. Linear module L 120 cm.
- > Système d'assises multiples. Revêtement mural en tissu. Element lineaire de 120 cm.
- > System aus mehreren Sitzmöbeln. Gepolsterte Wandverkleidung. Lineares Modul mit Länge von 120 cm.
- > Sistema de asientos múltiples. Revestimiento mural en tejido. Módulo lineal L 120 cm.



757

- > Sistema sedute multiple. Rivestimento a parete in tessuto. Modulo angolare terminale.
- > Modular seating system. Upholstered wall panel. Terminal corner module.
- > Système d'assises multiples. Revêtement mural en tissu. Element d'angle terminal.
- > System aus mehreren Sitzmöbeln. Gepolsterte Wandverkleidung. Terminaleckmodul.
- > Sistema de asientos múltiples. Revestimiento mural en tejido. Módulo de esquina final.



758

- > Sistema sedute multiple. Rivestimento a parete in tessuto. Modulo angolare (2 pezzi).
- > Modular seating system. Upholstered wall panel. Corner module (2 pieces).
- > Système d'assises multiples. Revêtement mural en tissu. Element d'angle (2 pièces).
- > System aus mehreren Sitzmöbeln. Gepolsterte Wandverkleidung. Eckmodul (2 Stücke).
- > Sistema de asientos múltiples. Revestimiento mural en tejido. Módulo de esquina (2 piezas).

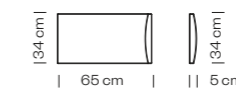
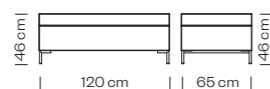
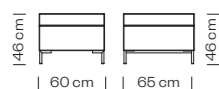

Peso / Weight / Poids / Gewicht / Peso **15 kg**

Imballo / Packaging / Emballage / Verpackung / Embalaje **0,28 m³**

Pezzi per scatola / Pieces per box / Pièces par carton / Stücke in einem Karton / Piezas por caja **1**

Peso / Weight / Poids / Gewicht / Peso **34 kg**

Imballo / Packaging / Emballage / Verpackung / Embalaje **0,45 m³**

Pezzi per scatola / Pieces per box / Pièces par carton / Stücke in einem Karton / Piezas por caja **1**

Peso / Weight / Poids / Gewicht / Peso **2 kg**

Imballo / Packaging / Emballage / Verpackung / Embalaje **0,18 m³**

Pezzi per scatola / Pieces per box / Pièces par carton / Stücke in einem Karton / Piezas por caja **4**

Peso / Weight / Poids / Gewicht / Peso **4 kg**

Imballo / Packaging / Emballage / Verpackung / Embalaje **0,18 m³**

Pezzi per scatola / Pieces per box / Pièces par carton / Stücke in einem Karton / Piezas por caja **4**

Peso / Weight / Poids / Gewicht / Peso **2 kg**

Imballo / Packaging / Emballage / Verpackung / Embalaje **0,18 m³**

Pezzi per scatola / Pieces per box / Pièces par carton / Stücke in einem Karton / Piezas por caja **4**

Peso / Weight / Poids / Gewicht / Peso **4 kg**

Imballo / Packaging / Emballage / Verpackung / Embalaje **0,18 m³**

Pezzi per scatola / Pieces per box / Pièces par carton / Stücke in einem Karton / Piezas por caja **2**



759

- > Sistema sedute multiple. Sedile e schienale imbottiti. Telaio in tubo acciaio. Modulo curvo 45°/C.
- > Modular seating system. Upholstered seat and back. Steel frame. Curved module 45° closed.
- > Système d'assises multiples. Assise et dossier rembourrés. Châssis en acier. Element courbe 45° C (angle fermé).
- > System aus mehreren Sitzmöbeln. Gepolsterte Sitzfläche und Rückenlehne. Gestell aus Stahlrohren. Gerundetes Modul 45°/C (geschlossen).
- > Sistema de asientos múltiples. Asiento y respaldo tapizados. Estructura tubular en acero. Módulo curvado 45°/C.

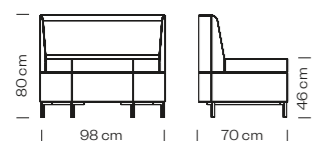

Peso / Weight / Poids / Gewicht / Peso **29 kg**

Imballo / Packaging / Emballage / Verpackung / Embalaje **0,60 m³**

Pezzi per scatola / Pieces per box / Pièces par carton / Stücke in einem Karton / Piezas por caja **1**



760

- > Sistema sedute multiple. Sedile e schienale imbottiti. Telaio in tubo acciaio. Modulo curvo 45°/A.
- > Modular seating system. Upholstered seat and back. Steel frame. Curved module 45° opened.
- > Système d'assises multiples. Assise et dossier rembourrés. Châssis en acier. Element courbe 45° A (angle ouvert).
- > System aus mehreren Sitzmöbeln. Gepolsterte Sitzfläche und Rückenlehne. Gestell aus Stahlrohren. Gerundetes Modul 45°/A (geöffnet).
- > Sistema de asientos múltiples. Asiento y respaldo tapizados. Estructura tubular en acero. Módulo curvado 45°/A.

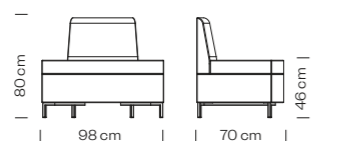

Peso / Weight / Poids / Gewicht / Peso **27,5 kg**

Imballo / Packaging / Emballage / Verpackung / Embalaje **0,60 m³**

Pezzi per scatola / Pieces per box / Pièces par carton / Stücke in einem Karton / Piezas por caja **1**



761

- > Sistema sedute multiple. Sedile imbottito. Telaio in tubo acciaio. Modulo curvo pouf 45°/A-C.
- > Modular seating system. Upholstered seat. Steel frame. Curved pouf module 45° opened/closed.
- > Système d'assises multiples. Assise rembourrée. Châssis en acier. Element courbe 45° A-C (angle ouvert et fermé).
- > System aus mehreren Sitzmöbeln. Gepolsterte Sitzfläche. Gestell aus Stahlrohren. Pouf gerundetes Modul 45°/A-C (geöffnet und geschlossen).
- > Sistema de asientos múltiples. Asiento tapizado. Estructura tubular en acero. Módulo pouf curvado 45°/A-C.

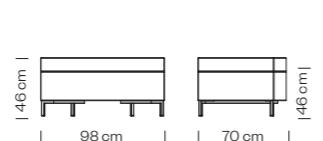

Peso / Weight / Poids / Gewicht / Peso **19 kg**

Imballo / Packaging / Emballage / Verpackung / Embalaje **0,35 m³**

Pezzi per scatola / Pieces per box / Pièces par carton / Stücke in einem Karton / Piezas por caja **1**

TE

- > Finiture seduta (vedi p. 359)
- > Seat finishes (see p. 359)
- > Finitions de l'assise (voir p. 359)
- > Sitzfertigung (sehen S. 359)
- > Acabados asiento (ver p. 359)

AC

- > Finiture telaio (vedi p. 395)
- > Frame finishes (see p. 395)
- > Finitions piètement (voir p. 395)
- > Gestell fertigung (sehen S. 395)
- > Acabados estructura (ver p. 395)



Accessori / Accessories / Accessoires / Zubehoer / Accesorios

- > Cuscini cilindrici
- > Tubular cushions
- > Coussins cylindriques
- > Kissen zylinder
- > Cojines cilindricos



echo

design
rdm, 2009



150

- > Sedia con telaio a 4 gambe in tubo acciaio. Seduta in tecnopolimero composito.
- > Chair with 4 legs steel frame and techno-polymer shell.
- > Chaise avec châssis en acier 4 pieds. Coque en techno-polymère.
- > Stuhl mit 4-beinigem Stahlgestell. Schale aus Zusammengesetztes Technopolymer.
- > Silla con estructura tubular 4 patas en acero. Carcasa en tecnopolímero compuesto.

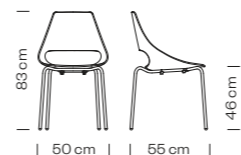

Peso / Weight / Poids / Gewicht / Peso

5,6 kg

Imballo / Packaging / Emballage / Verpackung / Embalaje

0,39 m³

Pezzi per scatola / Pieces per box / Pièces par carton / Stücke in einem Karton / Piezas por caja

4

Impilabile / Stackable / Empilable / Stapelbar / Apilable

4



151

- > Sedia con telaio a 4 gambe in tubo acciaio. Seduta in tecnopolimero composito.
- > Chair with 4 legs steel frame and techno-polymer shell.
- > Chaise avec châssis en acier 4 pieds. Coque en techno-polymère.
- > Stuhl mit 4-beinigem Stahlgestell. Schale aus Zusammengesetztes Technopolymer.
- > Silla con estructura tubular 4 patas en acero. Carcasa en tecnopolímero compuesto.

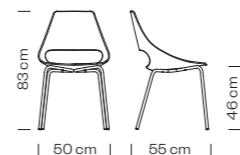

Peso / Weight / Poids / Gewicht / Peso

5 kg

Imballo / Packaging / Emballage / Verpackung / Embalaje

0,35 m³

Pezzi per scatola / Pieces per box / Pièces par carton / Stücke in einem Karton / Piezas por caja

2

Impilabile / Stackable / Empilable / Stapelbar / Apilable

4



152

- > Sedia con telaio a slitta in tondino acciaio. Seduta in tecnopolimero composito.
- > Chair with steel sled frame and techno-polymer shell.
- > Chaise avec châssis luge en fil d'acier. Coque en techno-polymère.
- > Stuhl mit Kufengestell aus Stahl. Schale aus Zusammengesetztes Technopolymer.
- > Silla con estructura patin en acero, carcasa en tecnopolímero compuesto.

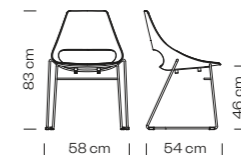

Peso / Weight / Poids / Gewicht / Peso

7,5 kg

Imballo / Packaging / Emballage / Verpackung / Embalaje

0,40 m³

Pezzi per scatola / Pieces per box / Pièces par carton / Stücke in einem Karton / Piezas por caja

4

Impilabile / Stackable / Empilable / Stapelbar / Apilable

4



152-G

- > Sedia con telaio a slitta in tondino acciaio e sistema aggancio. Seduta in tecnopolimero composito.
- > Chair with steel sled frame and linking device. Technopolymer shell.
- > Chaise avec châssis luge et système d'accrochage en fil d'acier. Coque en techno-polymère.
- > Stuhl mit Kufengestell aus Stahl und Verbindungssystem. Schale aus Zusammengesetztes Technopolymer.
- > Silla con estructura patin en acero y sistema de enganche, carcasa en tecnopolímero compuesto.

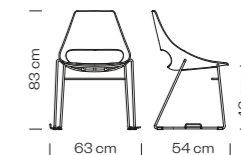

Peso / Weight / Poids / Gewicht / Peso

8,1 kg

Imballo / Packaging / Emballage / Verpackung / Embalaje

0,40 m³

Pezzi per scatola / Pieces per box / Pièces par carton / Stücke in einem Karton / Piezas por caja

4

Impilabile / Stackable / Empilable / Stapelbar / Apilable

4

Sistema di aggancio / Linking device / Système d'accrochage / Verbindungssystem / Sistema de enganche





153

- > Sedia con telaio a basamento centrale girevole in acciaio. Seduta in tecnopolimero composito.
- > Swivel chair with central steel base and technopolymer shell.
- > Chaise pivotante avec piètement central en acier, coque en technopolymère.
- > Stuhl mit Untergestell und mittlerem Standfuss aus Stahl, drehbar. Sitzfläche aus Zusammengesetztes Technopolymer.
- > Silla giratoria con base central en acero. Carcasa en tecnopolimero compuesto.



156

- > Sedia con telaio da mensa in tubo acciaio. Seduta in tecnopolimero composito.
- > Canteen steel frame, with technopolymer shell.
- > Chaise avec châssis en acier appui sur table, coque en technopolymère.
- > Stuhl mit Gestell mit vorderem, offenem Fußbügel und Sitzfläche aus Zusammengesetztes Technopolymer.
- > Silla con estructura de comedor en acero. Carcasa en tecnopolimero compuesto.



332

- > Sgabello con telaio a 4 gambe in tubo acciaio. Seduta in tecnopolimero composito.
- > Barstool with 4 legs steel frame and techno-polymer shell.
- > Tabouret avec châssis en acier 4 pieds. Coque en technopolymère.
- > Barhocker mit 4-beinigem Stahlgestell. Schale aus Zusammengesetztes Technopolymer.
- > Taburete con estructura tubular 4 patas en acero. Carcasa en tecnopolimero compuesto.



332B

- > Sgabello con telaio a 4 gambe in tubo acciaio. Seduta in tecnopolimero composito. Versione seduta H 65 cm.
- > Barstool with 4 legs steel frame and techno-polymer shell. Version seat-height H 65 cm.
- > Tabouret avec châssis en acier 4 pieds. Coque en technopolymère. Version hauteur assise 65 cm.
- > Barhocker mit 4-beinigem Stahlgestell. Schale aus Zusammengesetztes Technopolymer. Sitzhöhe 65 cm.
- > Taburete con estructura tubular 4 patas en acero. Carcasa en tecnopolimero compuesto. Altura asiento 65 cm.



333

- > Sgabello con telaio a basamento centrale in acciaio, girevole. Seduta in tecnopolimero composito.
- > Swivel barstool with central steel base and techno-polymer shell.
- > Tabouret pivotant avec piètement central en acier. Coque en technopolymère.
- > Barhocker mit Gestell auf zentralem Standfuss aus Stahl. Schale aus Zusammengesetztes Technopolymer.
- > Taburete con estructura columna central en acero, giratoria. Carcasa en tecnopolimero compuesto.



333B

- > Sgabello con telaio a basamento centrale in acciaio, girevole. Seduta in tecnopolimero composito. Versione seduta H 65 cm.
- > Swivel barstool with central steel base and techno-polymer shell. Version seat-height H 65 cm.
- > Tabouret pivotant avec piètement central en acier. Coque en technopolymère. Version hauteur assise 65 cm.
- > Barhocker mit Gestell auf zentralem Standfuss aus Stahl. Schale aus Zusammengesetztes Technopolymer. Sitzhöhe 65 cm.
- > Taburete con estructura columna central en acero, giratoria. Carcasa en tecnopolimero compuesto. Altura asiento 65 cm.

PP+PET

- > Finiture seduta
- > Seat finishes
- > Finitions de l'assise
- > Sitzfertigung
- > Acabados asiento

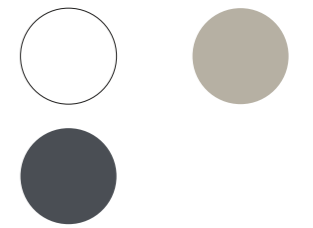

AC

- > Finiture telaio (vedi p. 395)
- > Frame finishes (see p. 395)
- > Finitions piètement (voir p. 395)
- > Gestell fertigungen (sehen S. 395)
- > Acabados estructura (ver p. 395)

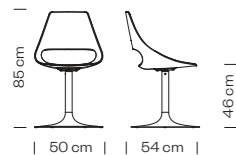

Peso / Weight / Poids / Gewicht / Peso

9,9 kg

Imballo / Packaging / Emballage / Verpackung / Embalaje

0,29 m³

Pezzi per scatola / Pieces per box / Pièces par carton / Stücke in einem Karton / Piezas por caja

1

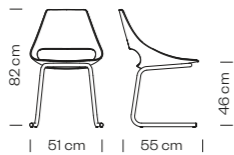

Peso / Weight / Poids / Gewicht / Peso

6 kg

Imballo / Packaging / Emballage / Verpackung / Embalaje

0,35 m³

Pezzi per scatola / Pieces per box / Pièces par carton / Stücke in einem Karton / Piezas por caja

2

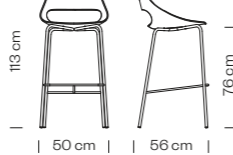

Peso / Weight / Poids / Gewicht / Peso

7 kg

Imballo / Packaging / Emballage / Verpackung / Embalaje

0,35 m³

Pezzi per scatola / Pieces per box / Pièces par carton / Stücke in einem Karton / Piezas por caja

1

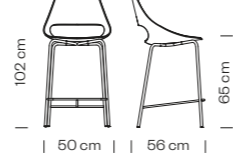

Peso / Weight / Poids / Gewicht / Peso

6,7 kg

Imballo / Packaging / Emballage / Verpackung / Embalaje

0,35 m³

Pezzi per scatola / Pieces per box / Pièces par carton / Stücke in einem Karton / Piezas por caja

1

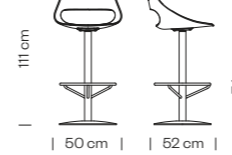

Peso / Weight / Poids / Gewicht / Peso

14 kg

Imballo / Packaging / Emballage / Verpackung / Embalaje

0,35 m³

Pezzi per scatola / Pieces per box / Pièces par carton / Stücke in einem Karton / Piezas por caja

1

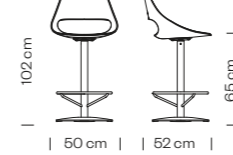

Peso / Weight / Poids / Gewicht / Peso

13,8 kg

Imballo / Packaging / Emballage / Verpackung / Embalaje

0,35 m³

Pezzi per scatola / Pieces per box / Pièces par carton / Stücke in einem Karton / Piezas por caja

1



Accessori / Accessories / Accessoires / Zubehoer / Accesorios

- > Cuscino in feltro rimovibile
- > Loose felt cushion
- > Coussin en feutre amovible
- > Filz Kissen entfernbar
- > Cojín de feltro removible

Finiture / Finishes / Finitions / Fertigungen / Acabados



Woolfelt 504



Woolfelt 604



kicca

design
Francesco Geraci, 2008



019

- > Poltroncina con telaio a basamento centrale girevole in acciaio. Sedile e schienale in tessuto.
- > Swivel armchair with central steel base. Upholstered seat and back.
- > Fauteuil pivotant avec piétement central en acier. Assise et dossier en tissu.
- > Armlehnstuhl mit Gestell auf zentralem, drehbarem Standfuss aus Stahl. Gepolsterte Sitzfläche und Rückenlehne.
- > Sillón con estructura columna central en acero, giratoria. Asiento y respaldo tapizados.



020

- > Poltroncina con telaio a 4 gambe in tubo acciaio. Sedile e schienale in tessuto.
- > Armchair with 4 legs steel frame and upholstered seat and back.
- > Fauteuil avec châssis 4 pieds en acier. Assise et dossier en tissu.
- > Armlehnstuhl mit 4-beinigem Stahlgestell. Gepolsterte Sitzfläche und Rückenlehne.
- > Sillón con estructura tubular 4 patas en acero. Asiento y respaldo tapizados.



021

- > Poltroncina con telaio a 4 razze in tubo acciaio. Sedile e schienale in tessuto.
- > Armchair with 4 ways steel frame. Upholstered seat and back.
- > Fauteuil avec châssis 4 branches en acier. Assise et dossier en tissu.
- > Armlehnstuhl mit 4-armigem Fusskreuz aus Stahl. Gepolsterte Sitzfläche und Rückenlehne.
- > Sillón con estructura tubular 4 radios en acero. Asiento y respaldo tapizados.



571

- > Poltroncina con telaio a 4 gambe in faggio. Sedile e schienale in tessuto.
- > Armchair with beech wood frame, 4 legs. Upholstered seat and back.
- > Fauteuil avec châssis 4 pieds en hêtre. Assise et dossier en tissu.
- > Armlehnstuhl mit 4-beinigem Buchenholzgestell. Gepolsterte Sitzfläche und Rückenlehne.
- > Sillón con estructura 4 patas en madera de haya. Asiento y respaldo tapizados.

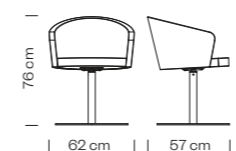

Peso / Weight / Poids / Gewicht / Peso **20 kg**

Imballo / Packaging / Emballage / Verpackung / Embalaje **0,32 m³**

Pezzi per scatola / Pieces per box / Pièces par carton / Stücke in einem Karton / Piezas por caja **1**

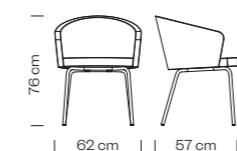

Peso / Weight / Poids / Gewicht / Peso **9,5 kg**

Imballo / Packaging / Emballage / Verpackung / Embalaje **0,32 m³**

Pezzi per scatola / Pieces per box / Pièces par carton / Stücke in einem Karton / Piezas por caja **1**

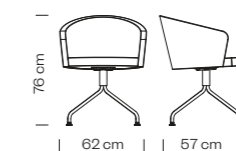

Peso / Weight / Poids / Gewicht / Peso **10 kg**

Imballo / Packaging / Emballage / Verpackung / Embalaje **0,32 m³**

Pezzi per scatola / Pieces per box / Pièces par carton / Stücke in einem Karton / Piezas por caja **1**

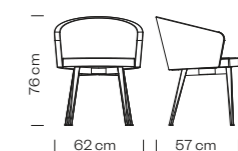

Peso / Weight / Poids / Gewicht / Peso **9,9 kg**

Imballo / Packaging / Emballage / Verpackung / Embalaje **0,32 m³**

Pezzi per scatola / Pieces per box / Pièces par carton / Stücke in einem Karton / Piezas por caja **1**



O21-DP

- > Poltroncina con telaio in alluminio a 5 razze, girevole. Sedile e schienale in tessuto.
- > Swivel armchair with 5 ways aluminium frame. Upholstered seat and back.
- > Fauteuil pivotant avec châssis en aluminium 5 branches avec patins. Assise et dossier en tissu.
- > Armlehnstuhl mit Aluminiumgestell, drehbar und mit 5-armigem Fusskreuz. Gepolsterte Sitzfläche und Rückenlehne.
- > Sillón con estructura 5 radios en aluminio, giratoria. Asiento y respaldo tapizados.



O21-DR

- > Poltroncina con telaio in alluminio a 5 razze, girevole, su ruote. Sedile e schienale in tessuto.
- > Swivel armchair with 5 ways aluminium frame on castors. Upholstered seat and back.
- > Fauteuil pivotant avec châssis en aluminium 5 branches avec roulettes. Assise et dossier en tissu.
- > Armlehnstuhl mit Aluminiumgestell, drehbar und mit 5-armigem Fusskreuz und Rollen. Gepolsterte Sitzfläche und Rückenlehne.
- > Sillón con estructura 5 radios en aluminio, giratoria, con ruedas. Asiento y respaldo tapizados.



320

- > Sgabello con telaio a basamento centrale girevole in acciaio. Sedile e schienale in tessuto.
- > Swivel stool with central steel base. Upholstered seat and back.
- > Tabouret pivotant avec piétement central en acier. Assise et dossier en tissu.
- > Barhocker mit Gestell auf zentralem, drehbarem Standfuss aus Stahl. Gepolsterte Sitzfläche und Rückenlehne.
- > Taburete con estructura columna central en acero, giratoria. Asiento y respaldo tapizados.



366

- > Sgabello con telaio a 4 gambe in tubo acciaio. Sedile e schienale in tessuto.
- > Barstool with steel frame and upholstered seat and back.
- > Tabouret avec châssis en acier 4 pieds. Assise et dossier en tissu.
- > Barhocker mit 4-beinigem Stahlgestell. Gepolsterte Sitzfläche und Rückenlehne.
- > Taburete con estructura tubular 4 patas en acero. Asiento y respaldo tapizados.

TE

- > Finiture seduta (vedi p. 359)
- > Seat finishes (see p. 359)
- > Finitions de l'assise (voir p. 359)
- > Sitzfertigung (sehen S. 359)
- > Acabados asiento (ver p. 359)

AC

- > Finiture telaio (vedi p. 395)
- > Frame finishes (see p. 395)
- > Finitions piètement (voir p. 395)
- > Gestell fertigung (sehen S. 395)
- > Acabados estructura (ver p. 395)



AL VR

- > Finiture telaio
- > Frame finishes
- > Finitions piètement
- > Gestell fertigung
- > Acabados estructura



LE

- > Finiture telaio
- > Frame finishes
- > Finitions piètement
- > Gestell fertigung
- > Acabados estructura

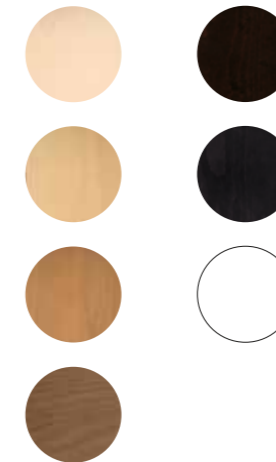

360°

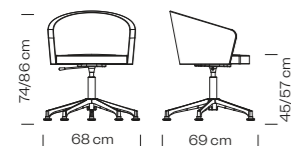

Peso / Weight / Poids / Gewicht / Peso **12 kg**

Imballo / Packaging / Emballage / Verpackung / Embalaje **0,39 m³**

Pezzi per scatola / Pieces per box / Pièces par carton / Stücke in einem Karton / Piezas por caja **1**

360°

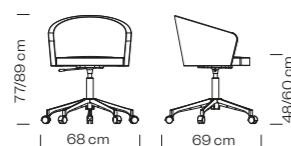

Peso / Weight / Poids / Gewicht / Peso **12 kg**

Imballo / Packaging / Emballage / Verpackung / Embalaje **0,50 m³**

Pezzi per scatola / Pieces per box / Pièces par carton / Stücke in einem Karton / Piezas por caja **1**

360°

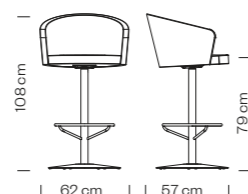

Peso / Weight / Poids / Gewicht / Peso **21,7 kg**

Imballo / Packaging / Emballage / Verpackung / Embalaje **0,44 m³**

Pezzi per scatola / Pieces per box / Pièces par carton / Stücke in einem Karton / Piezas por caja **1**

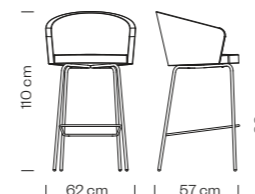

Peso / Weight / Poids / Gewicht / Peso **9,8 kg**

Imballo / Packaging / Emballage / Verpackung / Embalaje **0,44 m³**

Pezzi per scatola / Pieces per box / Pièces par carton / Stücke in einem Karton / Piezas por caja **1**

AL PSH

- > Finiture telaio (vedi p. 398)
- > Frame finishes (see p. 398)
- > Finitions piètement (voir p. 398)
- > Gestell fertigung (sehen S. 398)
- > Acabados estructura (ver p. 398)



net

design
Francesco Geraci, 2006



096

- > Sedia con telaio a slitta e seduta in tondino acciaio.
- > Chair with steel sled frame.
- > Chaise avec châssis luge en fil d'acier.
- > Stuhl mit Kufengestell aus elektroverschweißten Stahlrohren.
- > Silla con estructura patín en acero.



097

- > Poltroncina con telaio a slitta e seduta in tondino acciaio.
- > Armchair with steel sled frame.
- > Fauteuil avec châssis luge en fil d'acier.
- > Armlehnstuhl mit Kufengestell aus elektroverschweißten Stahlrohren.
- > Sillón con estructura patín en acero.



396

- > Sgabello con telaio a slitta e seduta in tondino acciaio.
- > Barstool with steel sled frame.
- > Tabouret avec châssis luge en fil d'acier.
- > Barhocker mit Kufengestell aus elektroverschweißten Stahlrohren.
- > Taburete con estructura patín en acero.



Peso / Weight / Poids / Gewicht / Peso **5,3 kg**

Imballo / Packaging / Emballage / Verpackung / Embalaje **0,36 m³**

Pezzi per scatola / Pieces per box / Pièces par carton / Stücke in einem Karton / Piezas por caja **4**

Impilabile / Stackable / Empilable / Stapelbar / Apilable **4**

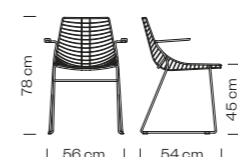

Peso / Weight / Poids / Gewicht / Peso **6,2 kg**

Imballo / Packaging / Emballage / Verpackung / Embalaje **0,36 m³**

Pezzi per scatola / Pieces per box / Pièces par carton / Stücke in einem Karton / Piezas por caja **4**

Impilabile / Stackable / Empilable / Stapelbar / Apilable **4**

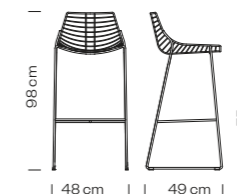

Peso / Weight / Poids / Gewicht / Peso **6 kg**

Imballo / Packaging / Emballage / Verpackung / Embalaje **0,25 m³**

Pezzi per scatola / Pieces per box / Pièces par carton / Stücke in einem Karton / Piezas por caja **1**



AC

- > Finiture seduta
(vedi p. 358)
- > Seat finishes
(see p. 358)
- > Finitions de l'assise
(voir p. 358)
- > Sitzfertigung
(sehen S. 358)
- > Acabados asiento
(ver p. 358)



Accessori / Accessories / Accessoires / Zubehoer / Accesorios

- > Cuscino in tessuto
- > Cushion in fabric
- > Coussin en tissu
- > Kissen aus Stoff
- > Cojín en tejido

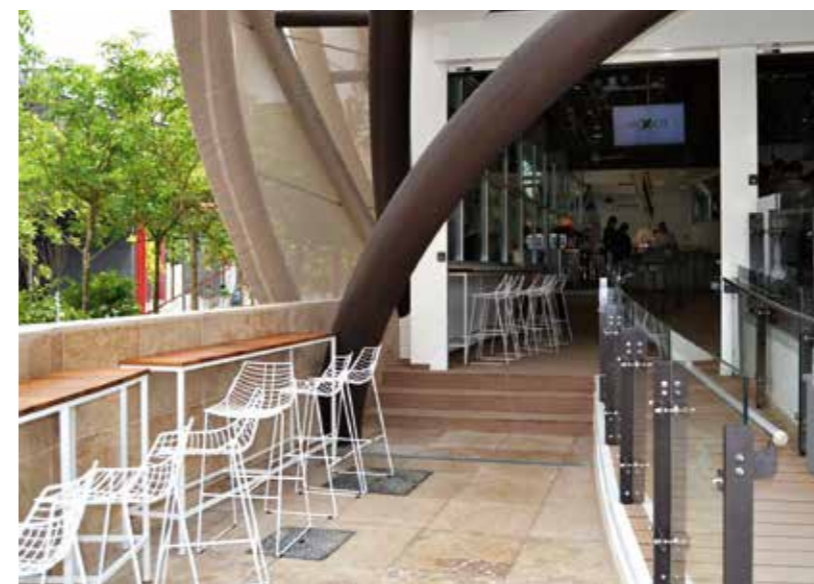

apple

design
Egidio Panzera, 2006



250



P0009

- > Pouf in polietilene stampato in rotazionale.
- > Pouf in polyethylene, rotational moulding.
- > Pouf en polyéthylène roto-moulé.
- > Hocker aus Rotationsverfahren gepresstem Polyäthylen.
- > Pouf en polietileno moldeado rotativo.

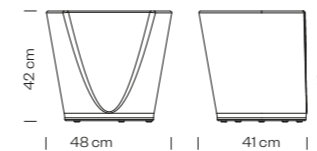

Peso / Weight /
Poids / Gewicht / Peso **3,5 kg**

Imballo / Packaging /
Emballage / Verpackung /
Embalaje **0,19 m³**

Pezzi per scatola /
Pieces per box /
Pièces par carton /
Stücke in einem Karton /
Piezas por caja **2**

251

PE

- > Finiture seduta
- > Seat finishes
- > Finitions de l'assise
- > Sitzfertigung
- > Acabados asiento

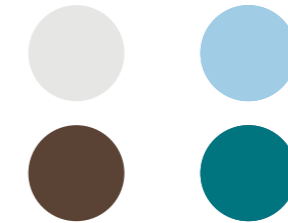



luna

design
rdm, 2005



103

- > Sedia con telaio a 4 gambe in tubo quadrato acciaio. Sedile e schienale in tessuto o faggio.
- > Chair with 4 legs squared steel frame, upholstered or beech wood seat and back.
- > Chaise avec châssis 4 pieds en acier tube carré, coque en hêtre ou en tissu.
- > Stuhl mit 4-beinigem eckigen Stahlgestell. Sitzfläche und Rückenlehne gepolstert mit Stoff oder aus Buchenholz.
- > Silla con estructura tubular cuadrada 4 patas en acero. Asiento y respaldo tapizados o en madera de haya.

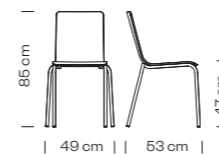

Peso / Weight / Poids / Gewicht / Peso **5,6 kg**

Imballo / Packaging / Emballage / Verpackung / Embalaje **0,39 m³**

Pezzi per scatola / Pieces per box / Pièces par carton / Stücke in einem Karton / Piezas por caja **4**

Impilabile / Stackable / Empilable / Stapelbar / Apilable **4***

* Non impilabile nella versione imbottita / not stackable in the upholstered version / non empilable



103-G

- > Sedia con telaio a 4 gambe in tubo quadrato acciaio e sistema aggancio. Sedile e schienale in tessuto o faggio.
- > Chair with 4 legs squared steel frame and linking device. Upholstered or beech wood seat and back.
- > Chaise avec châssis 4 pieds en acier tube carré, avec système d'accrochage, coque en hêtre ou en tissu.
- > Stuhl mit 4-beinigem eckigen Stahlgestell und Verbindungssystem. Sitzfläche und Rückenlehne gepolstert mit Stoff oder aus Buchenholz.
- > Silla con estructura tubular cuadrada 4 patas en acero y sistema de enganche. Asiento y respaldo tapizados o en madera de haya.

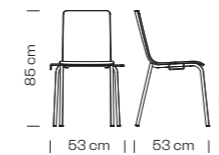

Peso / Weight / Poids / Gewicht / Peso **5,8 kg**

Imballo / Packaging / Emballage / Verpackung / Embalaje **0,40 m³**

Pezzi per scatola / Pieces per box / Pièces par carton / Stücke in einem Karton / Piezas por caja **4**

Impilabile / Stackable / Empilable / Stapelbar / Apilable **4***

dans la version rembourrée / nicht stapelbar In der gepolsterten Version / no apilable en la versión tapizada



104

- > Sedia con telaio a 4 gambe in tubo tondo acciaio. Sedile e schienale in tessuto o faggio.
- > Chair with 4 legs steel frame, upholstered or beech wood seat and back.
- > Chaise avec châssis 4 pieds en acier tube rond, coque en hêtre ou en tissu.
- > Stuhl mit 4-beinigem runden Stahlgestell. Sitzfläche und Rückenlehne gepolstert mit Stoff oder aus Buchenholz.
- > Silla con estructura tubular redonda 4 patas en acero. Asiento y respaldo tapizados o en madera de haya.

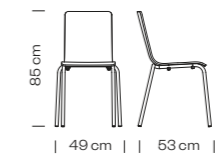

Peso / Weight / Poids / Gewicht / Peso **5,9 kg**

Imballo / Packaging / Emballage / Verpackung / Embalaje **0,39 m³**

Pezzi per scatola / Pieces per box / Pièces par carton / Stücke in einem Karton / Piezas por caja **4**

Impilabile / Stackable / Empilable / Stapelbar / Apilable **4***



107

- > Sedia con telaio a 4 gambe in faggio. Sedile e schienale in tessuto o faggio.
- > Chair with beech wood frame, 4 legs. Upholstered or beech wood seat and back.
- > Chaise avec châssis 4 pieds en hêtre, coque en hêtre ou en tissu.
- > Stuhl mit 4-beinigem Buchenholzgestell. Sitzfläche und Rückenlehne gepolstert mit Stoff oder aus Buchenholz.
- > Silla con estructura 4 patas en madera de haya. Asiento y respaldo tapizados o en madera de haya.

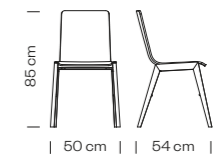

Peso / Weight / Poids / Gewicht / Peso **5,4 kg**

Imballo / Packaging / Emballage / Verpackung / Embalaje **0,39 m³**

Pezzi per scatola / Pieces per box / Pièces par carton / Stücke in einem Karton / Piezas por caja **2**

Impilabile / Stackable / Empilable / Stapelbar / Apilable **4**



330

- > Sgabello con telaio a basamento centrale girevole in acciaio. Sedile e schienale in tessuto o faggio.
- > Swivel barstool with central steel base. Upholstered or beech wood seat and back.
- > Tabouret pivotant avec piétement central en acier. Coque en hêtre ou en tissu.
- > Barhocker mit Gestell auf zentralem, drehbarem Standfuss aus Stahl. Sitzfläche und Rückenlehne gepolstert mit Stoff oder aus Buchenholz.
- > Taburete con estructura columnar central en acero, giratoria. Asiento y respaldo tapizados o en madera de haya.



334

- > Sgabello con telaio a 4 gambe in tubo quadrato acciaio. Sedile e schienale in tessuto o faggio.
- > Barstool with 4 legs squared steel frame. Upholstered or beech wood seat and back.
- > Tabouret avec châssis 4 pieds en acier tube carré, coque en hêtre ou en tissu.
- > Barhocker mit 4-beinigem Stahlgestell. Sitzfläche und Rückenlehne gepolstert mit Stoff oder aus Buchenholz.
- > Taburete con estructura tubular cuadrada 4 patas en acero. Asiento y respaldo tapizados o en madera de haya.

360°

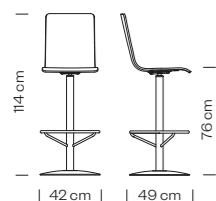

Peso / Weight / Poids / Gewicht / Peso **13,1 kg**

Imballo / Packaging / Emballage / Verpackung / Embalaje **0,29 m³**

Pezzi per scatola / Pieces per box / Pièces par carton / Stücke in einem Karton / Piezas por caja **1**

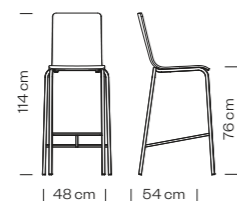

Peso / Weight / Poids / Gewicht / Peso **7,4 kg**

Imballo / Packaging / Emballage / Verpackung / Embalaje **0,50 m³**

Pezzi per scatola / Pieces per box / Pièces par carton / Stücke in einem Karton / Piezas por caja **2**

TE

- > Finiture seduta (vedi p. 359)
- > Seat finishes (see p. 359)
- > Finitions de l'assise (voir p. 359)
- > Sitzfertigungen (sehen S. 359)
- > Acabados asiento (ver p. 359)

LE

- > Finiture seduta
- > Seat finishes
- > Finitions de l'assise
- > Sitzfertigungen
- > Acabados asiento

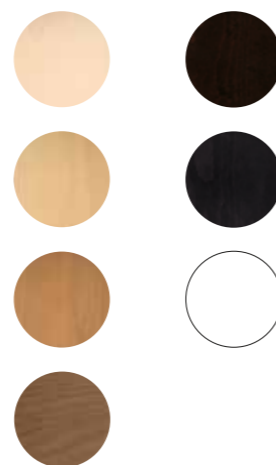

AC

- > Finiture telaio (vedi p. 395)
- > Frame finishes (see p. 395)
- > Finitions piètement (voir p. 395)
- > Gestell fertigungen (sehen S. 395)
- > Acabados estructura (ver p. 395)

LE

- > Finiture telaio
- > Frame finishes
- > Finitions piètement
- > Gestell fertigungen
- > Acabados estructura

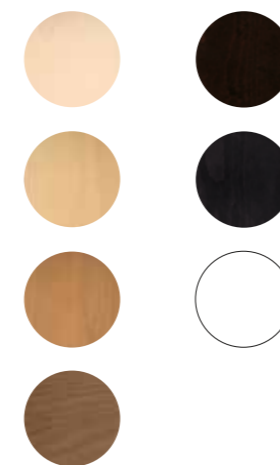

ibis

design
Francesco Geraci, 2004



258



002

- > Poltroncina con telaio a 4 gambe in tubo acciaio. Seduta in tecnopolimero composito.
- > Armchair with 4 legs steel frame and techno-polymer shell.
- > Fauteuil avec châssis 4 pieds en acier ou en inox brossé. Coque en techno-polymère.
- > Armlehnstuhl mit 4-beinigem Stahlgestell. Schale aus Zusammengesetztes Technopolymere.
- > Sillón con estructura tubular 4 patas en acero. Carcasa en tecnopolimero compuesto.



160

- > Poltroncina con telaio a slitta in tondino acciaio. Seduta in tecnopolimero composito.
- > Armchair with steel sled frame and techno-polymer shell.
- > Fauteuil avec châssis luge en fil d'acier. Coque en techno-polymère.
- > Armlehnstuhl mit Kufengestell aus Stahl. Schale aus Zusammengesetztes Technopolymere.
- > Sillón con estructura patín en acero, carcasa en tecnopolimero compuesto.



160-G

- > Poltroncina con telaio a slitta in tondino acciaio e sistema aggancio. Seduta in tecnopolimero composito.
- > Armchair with steel sled frame and linking device. Techno-polymer shell.
- > Fauteuil avec châssis luge en fil d'acier avec système d'accrochage. Coque en techno-polymère.
- > Armlehnstuhl mit Kufengestell aus Stahl und Verbindungssystem. Schale aus Zusammengesetztes Technopolymere.
- > Sillón con estructura patín en acero y sistema de enganche, carcasa en tecnopolimero compuesto.



139

- > Poltroncina con telaio a 4 gambe in faggio. Seduta in tecnopolimero composito.
- > Armchair with 4 legs, beech wood frame. Techno-polymer shell.
- > Fauteuil avec châssis 4 pieds en hêtre. Coque en techno-polymère.
- > Armlehnstuhl mit 4-beinigem Buchenholzgestell. Schale aus Zusammengesetztes Technopolymere.
- > Sillón con estructura 4 patas en madera de haya, carcasa en tecnopolimero compuesto.



Peso / Weight / Poids / Gewicht / Peso **4,7 kg**

Imballo / Packaging / Emballage / Verpackung / Embalaje **0,39 m³**

Pezzi per scatola / Pieces per box / Pièces par carton / Stücke in einem Karton / Piezas por caja **4**

Impilabile / Stackable / Empilable / Stapelbar / Apilable **4**

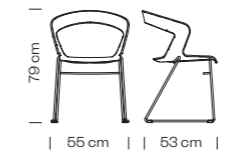

Peso / Weight / Poids / Gewicht / Peso **6,9 kg**

Imballo / Packaging / Emballage / Verpackung / Embalaje **0,39 m³**

Pezzi per scatola / Pieces per box / Pièces par carton / Stücke in einem Karton / Piezas por caja **4**

Impilabile / Stackable / Empilable / Stapelbar / Apilable **4**

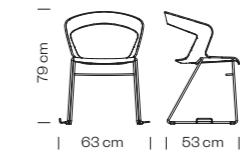

Peso / Weight / Poids / Gewicht / Peso **7,5 kg**

Imballo / Packaging / Emballage / Verpackung / Embalaje **0,39 m³**

Pezzi per scatola / Pieces per box / Pièces par carton / Stücke in einem Karton / Piezas por caja **4**

Impilabile / Stackable / Empilable / Stapelbar / Apilable **4**

Sistema di aggancio / Linking device / Système d'accrochage / Verbindungssystem / Sistema de enganche

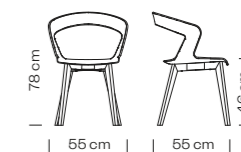

Peso / Weight / Poids / Gewicht / Peso **6 kg**

Imballo / Packaging / Emballage / Verpackung / Embalaje **0,34 m³**

Pezzi per scatola / Pieces per box / Pièces par carton / Stücke in einem Karton / Piezas por caja **1**

259



302

- > Sgabello con telaio a 4 gambe in tubo acciaio. Seduta in tecnopolimero composito.
- > Barstool with 4 legs steel frame and techno-polymer shell.
- > Tabouret avec châssis en acier 4 pieds. Coque en techno-polymère.
- > Barhocker mit 4-beinigem Stahlgestell. Schale aus Zusammengesetztes Technopolymer.
- > Taburete con estructura tubular 4 patas en acero, carcasa en tecnopolimero compuesto.



302B

- > Sgabello con telaio a 4 gambe in tubo acciaio. Seduta in tecnopolimero composito.
- > Barstool with 4 legs steel frame and techno-polymer shell. Seat height H 65 cm.
- > Tabouret avec châssis en acier 4 pieds. Coque en techno-polymère. Hauteur assise 65 cm.
- > Barhocker mit Gestell auf zentralem Standfuss aus Stahl. Schale aus Zusammengesetztes Technopolymer. Sitzhöhe 65 cm.
- > Taburete con estructura tubular 4 patas en acero, carcasa en tecnopolimero compuesto. Altura asiento 65 cm.



303

- > Sgabello con telaio a basamento centrale in acciaio, girevole. Seduta in tecnopolimero composito.
- > Swivel barstool with central steel base and techno-polymer shell.
- > Tabouret pivotant avec pietement central en acier. Coque en techno-polymère.
- > Barhocker mit Gestell auf zentralem Standfuss aus Stahl. Schale aus Zusammengesetztes Technopolymer.
- > Taburete con estructura columna central en acero, giratoria. Carcasa en tecnopolimero compuesto.



303B

- > Sgabello con telaio a basamento centrale in acciaio, girevole. Seduta in tecnopolimero composito.
- > Swivel barstool with central steel base and techno-polymer shell. Versione seduta H 65 cm.
- > Tabouret pivotant avec pietement central en acier. Coque en techno-polymère. Version hauteur assise 65 cm.
- > Barhocker mit Gestell auf zentralem Standfuss aus Stahl. Schale aus Zusammengesetztes Technopolymer. Sitzhöhe 65 cm.
- > Taburete con estructura columna central en acero, giratoria. Carcasa en tecnopolimero compuesto. Altura asiento 65 cm.



002-DP

- > Poltroncina con telaio a 5 razze in alluminio, girevole. Seduta in tecnopolimero composito.
- > Swivel armchair with 5 ways aluminium frame. Techno-polymer shell.
- > Fauteuil pivotant avec châssis en aluminium 5 branches avec patins. Coque en techno-polymère.
- > Armlehnstuhl mit Aluminiumgestell und 5-armigem Fusskreuz aus Aluminium. Schale aus Zusammengesetztes Technopolymer.
- > Sillón con estructura 5 radios en aluminio, giratoria, carcasa en tecnopolimero compuesto.



002-DR

- > Poltroncina con telaio a 5 razze in alluminio, girevole, su ruote. Seduta in tecnopolimero composito.
- > Swivel armchair with 5 ways on castors, aluminium frame. Techno-polymer shell.
- > Fauteuil pivotant avec châssis en aluminium 5 branches avec roulettes. Coque en techno-polymère.
- > Armlehnstuhl mit Aluminiumgestell und 5-armigem Fusskreuz und Rollen. Schale aus Zusammengesetztes Technopolymer.
- > Sillón con estructura 5 radios en aluminio, giratoria, con ruedas, carcasa en tecnopolimero compuesto.

PP+PET

- > Finiture seduta
- > Seat finishes
- > Finitions de l'assise
- > Sitzfertigung
- > Acabados asiento

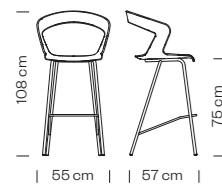
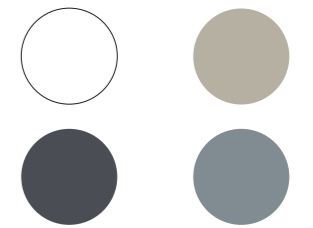

Peso / Weight / Poids / Gewicht / Peso **6,2 kg**

Imballo / Packaging / Emballage / Verpackung / Embalaje **0,35 m³**

Pezzi per scatola / Pieces per box / Pièces par carton / Stücke in einem Karton / Piezas por caja **1**

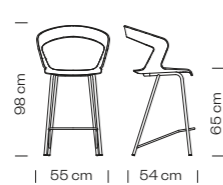

Peso / Weight / Poids / Gewicht / Peso **5,9 kg**

Imballo / Packaging / Emballage / Verpackung / Embalaje **0,35 m³**

Pezzi per scatola / Pieces per box / Pièces par carton / Stücke in einem Karton / Piezas por caja **1**

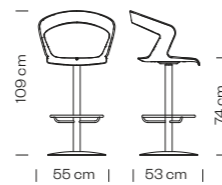

Peso / Weight / Poids / Gewicht / Peso **13,3 kg**

Imballo / Packaging / Emballage / Verpackung / Embalaje **0,35 m³**

Pezzi per scatola / Pieces per box / Pièces par carton / Stücke in einem Karton / Piezas por caja **1**

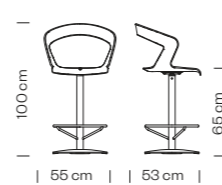

Peso / Weight / Poids / Gewicht / Peso **13 kg**

Imballo / Packaging / Emballage / Verpackung / Embalaje **0,35 m³**

Pezzi per scatola / Pieces per box / Pièces par carton / Stücke in einem Karton / Piezas por caja **1**

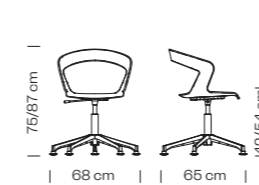

Peso / Weight / Poids / Gewicht / Peso **8,5 kg**

Imballo / Packaging / Emballage / Verpackung / Embalaje **0,39 m³**

Pezzi per scatola / Pieces per box / Pièces par carton / Stücke in einem Karton / Piezas por caja **1**

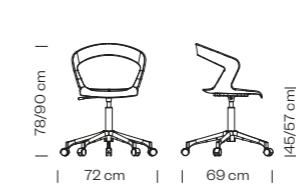

Peso / Weight / Poids / Gewicht / Peso **8,5 kg**

Imballo / Packaging / Emballage / Verpackung / Embalaje **0,39 m³**

Pezzi per scatola / Pieces per box / Pièces par carton / Stücke in einem Karton / Piezas por caja **1**



Accessori / Accessories / Accessoires / Zubehoer / Accesorios

- > Cuscino in feltro rimovibile
- > Loose felt cushion
- > Coussin en feutre amovible
- > Filz Kissen entfernbar
- > Cojín de fieltro removible

Finiture / Finishes / Finitions / Fertigungen / Acabados



Woolfelt 504



Woolfelt 604

AC

- > Finiture telaio (vedi p. 395)
- > Frame finishes (see p. 395)
- > Finitions piètement (voir p. 395)
- > Gestell fertigungen (sehen S. 395)
- > Acabados estructura (ver p. 395)

AL PSH

- > Finiture telaio (vedi p. 398)
- > Frame finishes (see p. 398)
- > Finitions piètement (voir p. 398)
- > Gestell fertigungen (sehen S. 398)
- > Acabados estructura (ver p. 398)

LE

- > Finiture telaio
- > Frame finishes
- > Finitions piètement
- > Gestell fertigungen
- > Acabados estructura

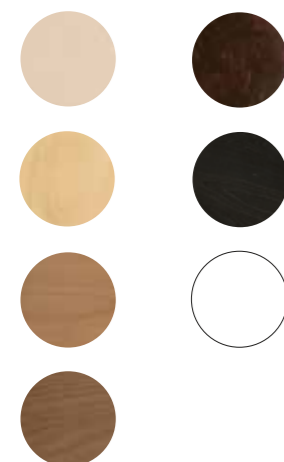

AL VR

- > Finiture telaio
- > Frame finishes
- > Finitions piètement
- > Gestell fertigungen
- > Acabados estructura



boom

design
Emilio Nanni, 2004



P0007

- > Pouf imbottito.
- > Upholstered pouf.
- > Pouf rembourrée.
- > Gepolsterter Hocker.
- > Pouf tapizado.

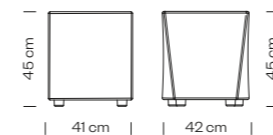

Peso / Weight /
Poids / Gewicht / Peso **8,5 kg**

Imballo / Packaging /
Emballage / Verpackung /
Embalaje **0,18 m³**

Pezzi per scatola /
Pieces per box /
Pièces par carton /
Stücke in einem Karton /
Piezas por caja **2**



P0008

- > Pouf in polietilene stampato
in rotazionale.
- > Pouf in polyethylene, rotational
moulding.
- > Pouf en polyéthylène roto-moulé.
- > Hocker aus im Rotationsverfahren
gepresstem Polyäthylen.
- > Pouf en polietileno moldeado
rotativo.

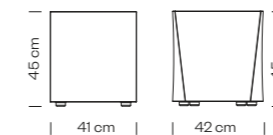

Peso / Weight /
Poids / Gewicht / Peso **4 kg**

Imballo / Packaging /
Emballage / Verpackung /
Embalaje **0,16 m³**

Pezzi per scatola /
Pieces per box /
Pièces par carton /
Stücke in einem Karton /
Piezas por caja **2**

PE

- > Finiture seduta
- > Seat finishes
- > Finitions de l'assise
- > Sitzfertigung
- > Acabados asiento

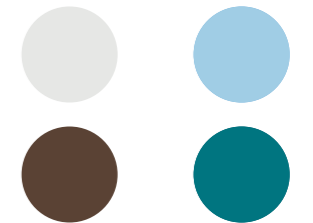

TE

- > Finiture seduta
(vedi p. 359)
- > Seat finishes
(see p. 359)
- > Finitions de l'assise
(voir p. 359)
- > Sitzfertigung
(sehen S. 359)
- > Acabados asiento
(ver p. 359)



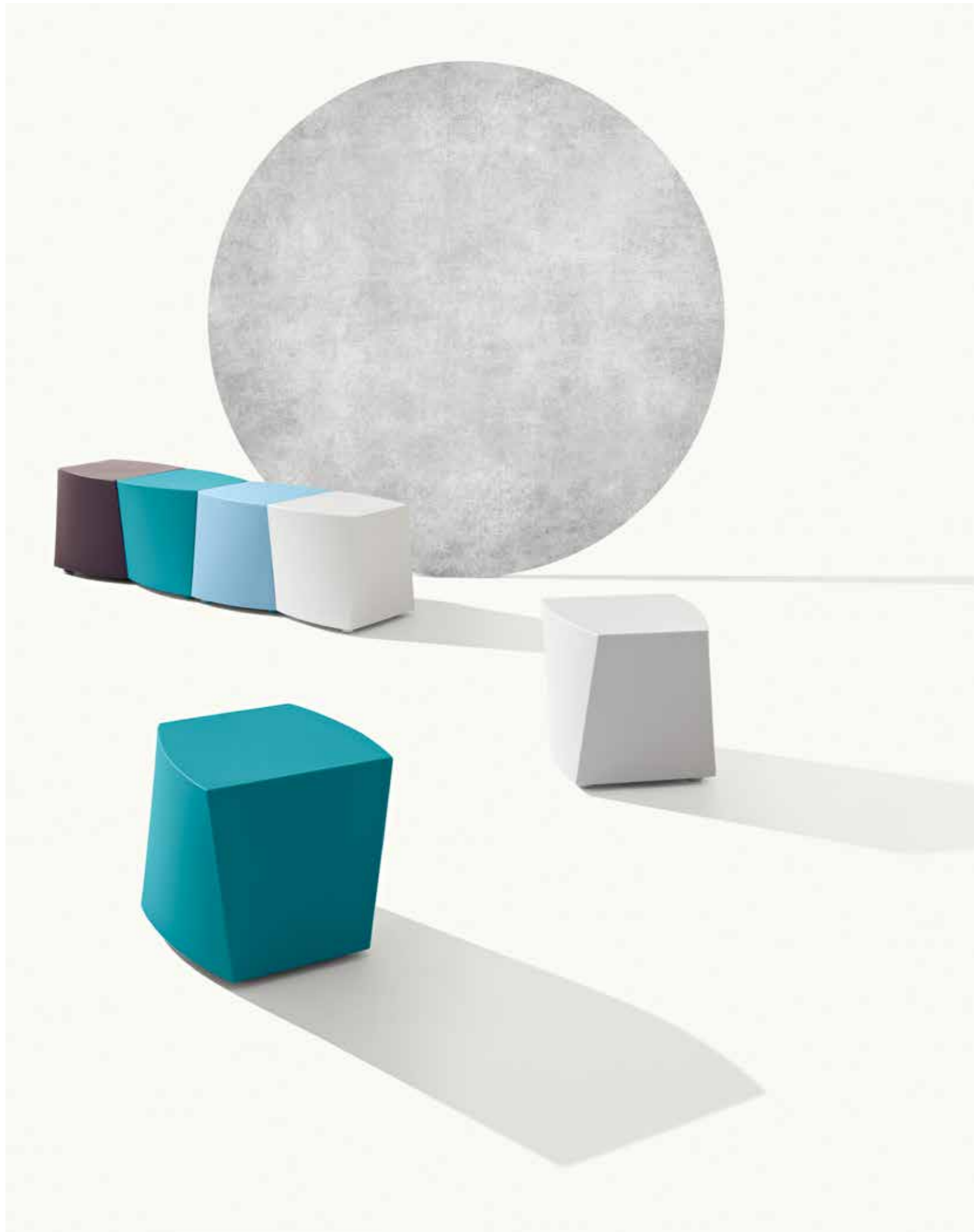

space

design
rdm, 2003



242

- > Sistema sedute multiple. Sedile e schienale imbottiti. Fianco, zoccolo e retro in laminato (fianco sp.2 cm). Modulo angolare. Versione schienale H 87 cm.
- > Modular seating system. Upholstered seat and back. Laminate front, side and rear (side thickness 2 cm). Corner module. Backrest H 87 cm.
- > Banquettes multiples. Assise et dossier rembourrés, revêtement en tissu, plinthe joues et arrière en stratifié (ep. 2 cm). Module d'angle. Version hauteur dossier 87 cm.
- > System aus mehreren Sitzmöbeln. Gepolsterte Sitzfläche und Rückenlehne. Seitenteil, Sockel und Hinten aus Laminat. (Seitenteil 2 cm Dicke). Eckiges Modul. Rückenlehne H 87 cm.
- > Sistema de asientos múltiples. Asiento y respaldo tapizados. Base frente, trasera y lado (Lado esp.2 cm) en laminado. Módulo de esquina. Altura respaldo 87 cm.

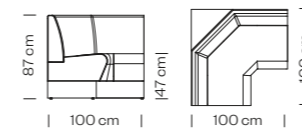

Peso / Weight / Poids / Gewicht / Peso **60 kg**

Imballo / Packaging / Emballage / Verpackung / Embalaje **1,05 m³**

Pezzi per scatola / Pieces per box / Pièces par carton / Stücke in einem Karton / Piezas por caja **1**



243

- > Sistema sedute multiple. Sedile e schienale imbottiti. Fianco, zoccolo e retro in laminato (fianco sp.2 cm). Modulo lineare. Versione schienale H 87 cm.
- > Modular seating system. Upholstered seat and back. Laminate front, side and rear (side thickness 2 cm). Corner module. Backrest H 87 cm.
- > Banquettes multiples. Assise et dossier rembourrés, revêtement en tissu, plinthe joues et arrière en stratifié (ep. 2 cm). Module d'angle. Version hauteur dossier 87 cm.
- > System aus mehreren Sitzmöbeln. Gepolsterte Sitzfläche und Rückenlehne. Seitenteil, Sockel und Hinten aus Laminat. (Seitenteil 2 cm Dicke). Eckiges Modul. Rückenlehne H 87 cm.
- > Sistema de asientos múltiples. Asiento y respaldo tapizados. Base frente, trasera y lado (Lado esp.2 cm) en laminado. Módulo de esquina. Altura respaldo 87 cm.

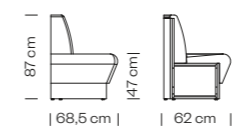

Peso / Weight / Poids / Gewicht / Peso **30 kg**

Imballo / Packaging / Emballage / Verpackung / Embalaje **0,50 m³**

Pezzi per scatola / Pieces per box / Pièces par carton / Stücke in einem Karton / Piezas por caja **1**



249

- > Sistema sedute multiple. Sedile e schienale imbottiti. Fianco, zoccolo e retro in laminato (fianco sp.2 cm). Modulo lineare 120 cm. Versione schienale H 87 cm.
- > Modular seating system. Upholstered seat and back. Laminate front, side and rear (side thickness 2 cm). Linear module 120 cm. Backrest H 87 cm.
- > Banquettes multiples. Assise et dossier rembourrés, revêtement en tissu, plinthe joues et arrière en stratifié (ep. 2 cm). Module linéaire 120 cm. Version hauteur dossier 87 cm.
- > System aus mehreren Sitzmöbeln. Gepolsterte Sitzfläche und Rückenlehne. Seitenteil, Sockel und Hinten aus Laminat. (Seitenteil 2 cm Dicke). Lineares Modul 120 cm. Rückenlehne H 87 cm.
- > Sistema de asientos múltiples. Asiento y respaldo tapizados. Base frente, trasera y lado (Lado esp.2 cm) en laminado. Módulo lineal L.120 cm. Altura respaldo 87 cm.

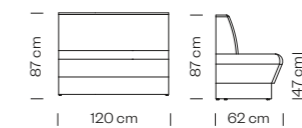

Peso / Weight / Poids / Gewicht / Peso **56 kg**

Imballo / Packaging / Emballage / Verpackung / Embalaje **0,82 m³**

Pezzi per scatola / Pieces per box / Pièces par carton / Stücke in einem Karton / Piezas por caja **1**



249 h120

- > Sistema sedute multiple. Sedile e schienale imbottiti. Fianco, zoccolo e retro in laminato (fianco sp.2 cm). Modulo lineare 120 cm. Versione schienale H 120 cm.
- > Modular seating system. Upholstered seat and back. Laminate front, side and rear (side thickness 2 cm). Linear module 120 cm. Backrest H 120 cm.
- > Banquettes multiples. Assise et dossier rembourrés, revêtement en tissu, plinthe joues et arrière en stratifié (ep. 2 cm). Module linéaire 120 cm. Version hauteur dossier 120 cm.
- > System aus mehreren Sitzmöbeln. Gepolsterte Sitzfläche und Rückenlehne. Seitenteil, Sockel und Hinten aus Laminat. (Seitenteil 2 cm Dicke). Lineares Modul 120 cm. Rückenlehne H 120 cm.
- > Sistema de asientos múltiples. Asiento y respaldo tapizados. Base frente, trasera y lado (Lado esp.2 cm) en laminado. Módulo lineal L.120 cm. Altura respaldo 120 cm.

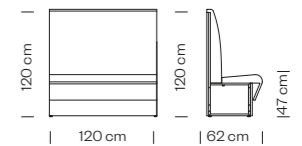

Peso / Weight / Poids / Gewicht / Peso **47 kg**

Imballo / Packaging / Emballage / Verpackung / Embalaje **1,18 m³**

Pezzi per scatola / Pieces per box / Pièces par carton / Stücke in einem Karton / Piezas por caja **1**



249 h160

- > Sistema sedute multiple. Sedile e schienale imbottiti. Fianco, zoccolo e retro in laminato (fianco sp.2 cm). Modulo lineare 120 cm. Versione schienale H 160 cm.
- > Modular seating system. Upholstered seat and back. Laminate front, side and rear (side thickness 2 cm). Linear module 120 cm. Backrest H 160 cm.
- > Banquettes multiples. Assise et dossier rembourrés, revêtement en tissu, plinthe joues et arrière en stratifié (ep. 2 cm). Module linéaire 120 cm. Version hauteur dossier 160 cm.
- > System aus mehreren Sitzmöbeln. Gepolsterte Sitzfläche und Rückenlehne. Seitenteil, Sockel und Hinten aus Laminat. (Seitenteil 2 cm Dicke). Lineares Modul 120 cm. Rückenlehne H 160 cm.
- > Sistema de asientos múltiples. Asiento y respaldo tapizados. Base frente, trasera y lado (Lado esp.2 cm) en laminado. Módulo lineal L.120 cm. Altura respaldo 160 cm.



250

- > Sistema sedute multiple. Sedile e schienale imbottiti. Fianco, zoccolo e retro in laminato (fianco sp.2 cm). Modulo lineare 80 cm. Versione schienale H 87 cm.
- > Modular seating system. Upholstered seat and back. Laminate front, side and rear (side thickness 2 cm). Linear module 80 cm. Backrest H 87 cm.
- > Banquettes multiples. Assise et dossier rembourrés, revêtement en tissu, plinthe joues et arrière en stratifié (ep. 2 cm). Module linéaire 80 cm. Version hauteur dossier 87 cm.
- > System aus mehreren Sitzmöbeln. Gepolsterte Sitzfläche und Rückenlehne. Seitenteil, Sockel und Hinten aus Laminat. (Seitenteil 2 cm Dicke). Lineares Modul 80 cm. Rückenlehne H 87 cm.
- > Sistema de asientos múltiples. Asiento y respaldo tapizados. Base frente, trasera y lado (Lado esp.2 cm) en laminado. Módulo lineal L.80 cm. Altura respaldo 87 cm.



250 h120

- > Sistema sedute multiple. Sedile e schienale imbottiti. Fianco, zoccolo e retro in laminato (fianco sp.2 cm). Modulo lineare 80 cm. Versione schienale H 120 cm.
- > Modular seating system. Upholstered seat and back. Laminate front, side and rear (side thickness 2 cm). Linear module 80 cm. Backrest H 120 cm.
- > Banquettes multiples. Assise et dossier rembourrés, revêtement en tissu, plinthe joues et arrière en stratifié (ep. 2 cm). Module linéaire 80 cm. Version hauteur dossier 120 cm.
- > System aus mehreren Sitzmöbeln. Gepolsterte Sitzfläche und Rückenlehne. Seitenteil, Sockel und Hinten aus Laminat. (Seitenteil 2 cm Dicke). Lineares Modul 80 cm. Rückenlehne H 120 cm.
- > Sistema de asientos múltiples. Asiento y respaldo tapizados. Base frente, trasera y lado (Lado esp.2 cm) en laminado. Módulo lineal L.80 cm. Altura respaldo 120 cm.



250 h160

- > Sistema sedute multiple. Sedile e schienale imbottiti. Fianco, zoccolo e retro in laminato (fianco sp.2 cm). Modulo lineare 80 cm. Versione schienale H 160 cm.
- > Modular seating system. Upholstered seat and back. Laminate front, side and rear (side thickness 2 cm). Linear module 80 cm. Backrest H 160 cm.
- > Banquettes multiples. Assise et dossier rembourrés, revêtement en tissu, plinthe joues et arrière en stratifié (ep. 2 cm). Module linéaire 80 cm. Version hauteur dossier 160 cm.
- > System aus mehreren Sitzmöbeln. Gepolsterte Sitzfläche und Rückenlehne. Seitenteil, Sockel und Hinten aus Laminat. (Seitenteil 2 cm Dicke). Lineares Modul 80 cm. Rückenlehne H 160 cm.
- > Sistema de asientos múltiples. Asiento y respaldo tapizados. Base frente, trasera y lado (Lado esp.2 cm) en laminado. Módulo lineal L.80 cm. Altura respaldo 160 cm.



251

- > Sistema sedute multiple. Sedile e schienale imbottiti. Fianco, zoccolo e retro in laminato (fianco sp.2 cm). Modulo lineare 70 cm. Versione schienale H 87 cm.
- > Modular seating system. Upholstered seat and back. Laminate front, side and rear (side thickness 2 cm). Linear module 70 cm. Backrest H 87 cm.
- > Banquettes multiples. Assise et dossier rembourrés, revêtement en tissu, plinthe joues et arrière en stratifié (ep. 2 cm). Module linéaire 70 cm. Version hauteur dossier 87 cm.
- > System aus mehreren Sitzmöbeln. Gepolsterte Sitzfläche und Rückenlehne. Seitenteil, Sockel und Hinten aus Laminat. (Seitenteil 2 cm Dicke). Lineares Modul 70 cm. Rückenlehne H 87 cm.
- > Sistema de asientos múltiples. Asiento y respaldo tapizados. Base frente, trasera y lado (Lado esp.2 cm) en laminado. Módulo lineal L.70 cm. Altura respaldo 87 cm.



251 h120

- > Sistema sedute multiple. Sedile e schienale imbottiti. Fianco, zoccolo e retro in laminato (fianco sp.2 cm). Modulo lineare 70 cm. Versione schienale H 120 cm.
- > Modular seating system. Upholstered seat and back. Laminate front, side and rear (side thickness 2 cm). Linear module 70 cm. Backrest H 120 cm.
- > Banquettes multiples. Assise et dossier rembourrés, revêtement en tissu, plinthe joues et arrière en stratifié (ep. 2 cm). Module linéaire 70 cm. Version hauteur dossier 120 cm.
- > System aus mehreren Sitzmöbeln. Gepolsterte Sitzfläche und Rückenlehne. Seitenteil, Sockel und Hinten aus Laminat. (Seitenteil 2 cm Dicke). Lineares Modul 70 cm. Rückenlehne H 120 cm.
- > Sistema de asientos múltiples. Asiento y respaldo tapizados. Base frente, trasera y lado (Lado esp.2 cm) en laminado. Módulo lineal L.70 cm. Altura respaldo 120 cm.



251 h160

- > Sistema sedute multiple. Sedile e schienale imbottiti. Fianco, zoccolo e retro in laminato (fianco sp.2 cm). Modulo lineare 70 cm. Versione schienale H 160 cm.
- > Modular seating system. Upholstered seat and back. Laminate front, side and rear (side thickness 2 cm). Linear module 70 cm. Backrest H 160 cm.
- > Banquettes multiples. Assise et dossier rembourrés, revêtement en tissu, plinthe joues et arrière en stratifié (ep. 2 cm). Module linéaire 70 cm. Version hauteur dossier 160 cm.
- > System aus mehreren Sitzmöbeln. Gepolsterte Sitzfläche und Rückenlehne. Seitenteil, Sockel und Hinten aus Laminat. (Seitenteil 2 cm Dicke). Lineares Modul 70 cm. Rückenlehne H 160 cm.
- > Sistema de asientos múltiples. Asiento y respaldo tapizados. Base frente, trasera y lado (Lado esp.2 cm) en laminado. Módulo lineal L.70 cm. Altura respaldo 160 cm.



252

- > Sistema sedute multiple. Sedile e schienale imbottiti. Fianco, zoccolo e retro in laminato (fianco sp.2 cm). Modulo angolare. Versione schienale H 87 cm.
- > Modular seating system. Upholstered seat and back. Laminate front, side and rear (side thickness 2 cm). Corner module. Backrest H 87 cm.
- > Banquettes multiples. Assise et dossier rembourrés, revêtement en tissu, plinthe joues et arrière en stratifié (ep. 2 cm). Module d'angle. Version hauteur dossier 87 cm.
- > System aus mehreren Sitzmöbeln. Gepolsterte Sitzfläche und Rückenlehne. Seitenteil, Sockel und Hinten aus Laminat. (Seitenteil 2 cm Dicke). Eckiges Modul. Rückenlehne H 87 cm.
- > Sistema de asientos múltiples. Asiento y respaldo tapizados. Base frente, trasera y lado (Lado esp.2 cm) en laminado. Módulo de esquina. Altura respaldo 87 cm.

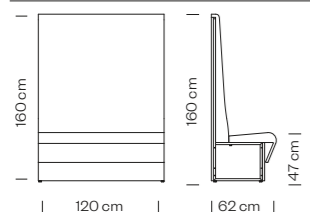

Peso / Weight / Poids / Gewicht / Peso **54 kg**

Imballo / Packaging / Emballage / Verpackung / Embalaje **1,55 m³**

Pezzi per scatola / Pieces per box / Pièces par carton / Stücke in einem Karton / Piezas por caja **1**

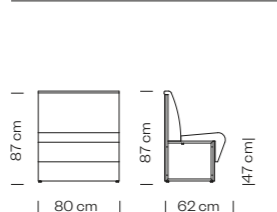

Peso / Weight / Poids / Gewicht / Peso **38 kg**

Imballo / Packaging / Emballage / Verpackung / Embalaje **0,56 m³**

Pezzi per scatola / Pieces per box / Pièces par carton / Stücke in einem Karton / Piezas por caja **1**

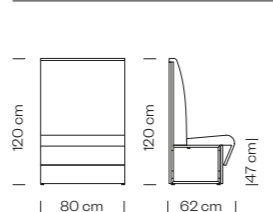

Peso / Weight / Poids / Gewicht / Peso **36 kg**

Imballo / Packaging / Emballage / Verpackung / Embalaje **0,82 m³**

Pezzi per scatola / Pieces per box / Pièces par carton / Stücke in einem Karton / Piezas por caja **1**

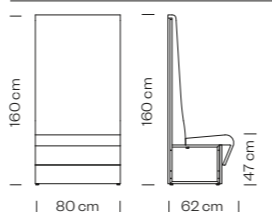

Peso / Weight / Poids / Gewicht / Peso **42 kg**

Imballo / Packaging / Emballage / Verpackung / Embalaje **1,07 m³**

Pezzi per scatola / Pieces per box / Pièces par carton / Stücke in einem Karton / Piezas por caja **1**

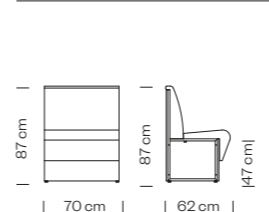

Peso / Weight / Poids / Gewicht / Peso **34 kg**

Imballo / Packaging / Emballage / Verpackung / Embalaje **0,50 m³**

Pezzi per scatola / Pieces per box / Pièces par carton / Stücke in einem Karton / Piezas por caja **1**

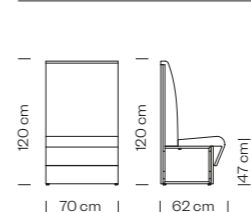

Peso / Weight / Poids / Gewicht / Peso **33 kg**

Imballo / Packaging / Emballage / Verpackung / Embalaje **0,73 m³**

Pezzi per scatola / Pieces per box / Pièces par carton / Stücke in einem Karton / Piezas por caja **1**

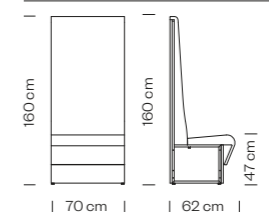

Peso / Weight / Poids / Gewicht / Peso **39 kg**

Imballo / Packaging / Emballage / Verpackung / Embalaje **0,95 m³**

Pezzi per scatola / Pieces per box / Pièces par carton / Stücke in einem Karton / Piezas por caja **1**

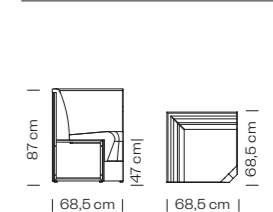

Peso / Weight / Poids / Gewicht / Peso **36 kg**

Imballo / Packaging / Emballage / Verpackung / Embalaje **0,50 m³**

Pezzi per scatola / Pieces per box / Pièces par carton / Stücke in einem Karton / Piezas por caja **1**



252 h120

- > Sistema sedute multiple. Sedile e schienale imbottiti. Fianco, zoccolo e retro in laminato (fianco sp.2 cm). Modulo angolare. Versione schienale H 120 cm.
- > Modular seating system. Upholstered seat and back. Laminate front, side and rear (side thickness 2 cm). Corner module. Backrest H 120 cm.
- > Banquettes multiples. Assise et dossier rembourrés, revêtement en tissu, plinthe joues et arrière en stratifié (ep. 2 cm). Module d'angle. Version hauteur dossier 120 cm.
- > System aus mehreren Sitzmöbeln. Gepolsterte Sitzfläche und Rückenlehne. Seitenteil, Sockel und Hinten aus Laminat. (Seitenteil 2 cm Dicke). Eckiges Modul. Rückenlehne H 120 cm.
- > Sistema de asientos múltiples. Asiento y respaldo tapizados. Base frente, trasera y lado (Lado esp.2 cm) en laminado. Módulo de esquina. Altura respaldo 120 cm.



252 h160

- > Sistema sedute multiple. Sedile e schienale imbottiti. Fianco, zoccolo e retro in laminato (fianco sp.2 cm). Modulo angolare. Versione schienale H 160 cm.
- > Modular seating system. Upholstered seat and back. Laminate front, side and rear (side thickness 2 cm). Corner module. Backrest H 160 cm.
- > Banquettes multiples. Assise et dossier rembourrés, revêtement en tissu, plinthe joues et arrière en stratifié (ep. 2 cm). Module d'angle. Version hauteur dossier 160 cm.
- > System aus mehreren Sitzmöbeln. Gepolsterte Sitzfläche und Rückenlehne. Seitenteil, Sockel und Hinten aus Laminat. (Seitenteil 2 cm Dicke). Eckiges Modul. Rückenlehne H 160 cm.
- > Sistema de asientos múltiples. Asiento y respaldo tapizados. Base frente, trasera y lado (Lado esp.2 cm) en laminado. Módulo de esquina. Altura respaldo 160 cm.



765

- > Sistema sedute multiple. Sedile e schienale imbottiti. Fianco, zoccolo e retro in laminato (fianco sp.2 cm). Modulo lineare 120 cm. Versione seduta H 75 cm.
- > Modular seating system. Upholstered seat and back. Laminate front, side and rear (side thickness 2 cm). Linear module 120 cm. Backrest H 75 cm.
- > Banquettes multiples. Assise et dossier rembourrés, revêtement en tissu, plinthe joues et arrière en stratifié (ep. 2 cm). Module linéaire 120 cm. Version hauteur assise 75 cm.
- > System aus mehreren Sitzmöbeln. Gepolsterte Sitzfläche und Rückenlehne. Seitenteil, Sockel und Hinten aus Laminat. (Seitenteil 2 cm Dicke). Lineares Modul 120 cm. Sitzhöhe H 75 cm.
- > Sistema de asientos múltiples. Asiento y respaldo tapizados. Base frente, trasera y lado (Lado esp.2 cm) en laminado. Módulo lineal L.120 cm. Altura asiento 75 cm.



766

- > Sistema sedute multiple. Sedile e schienale imbottiti. Fianco, zoccolo e retro in laminato (fianco sp.2 cm). Modulo lineare 80 cm. Versione seduta H 75 cm.
- > Modular seating system. Upholstered seat and back. Laminate front, side and rear (side thickness 2 cm). Linear module 80 cm. Backrest H 75 cm.
- > Banquettes multiples. Assise et dossier rembourrés, revêtement en tissu, plinthe joues et arrière en stratifié (ep. 2 cm). Module linéaire 80 cm. Version hauteur assise 75 cm.
- > System aus mehreren Sitzmöbeln. Gepolsterte Sitzfläche und Rückenlehne. Seitenteil, Sockel und Hinten aus Laminat. (Seitenteil 2 cm Dicke). Lineares Modul 80 cm. Sitzhöhe H 75 cm.
- > Sistema de asientos múltiples. Asiento y respaldo tapizados. Base frente, trasera y lado (Lado esp.2 cm) en laminado. Módulo lineal L.80 cm. Altura asiento 75 cm.



767

- > Sistema sedute multiple. Sedile e schienale imbottiti. Fianco, zoccolo e retro in laminato (fianco sp.2 cm). Modulo lineare 70 cm. Versione seduta H 75 cm.
- > Modular seating system. Upholstered seat and back. Laminate front, side and rear (side thickness 2 cm). Linear module 70 cm. Backrest H 75 cm.
- > Banquettes multiples. Assise et dossier rembourrés, revêtement en tissu, plinthe joues et arrière en stratifié (ep. 2 cm). Module linéaire 70 cm. Version hauteur assise 75 cm.
- > System aus mehreren Sitzmöbeln. Gepolsterte Sitzfläche und Rückenlehne. Seitenteil, Sockel und Hinten aus Laminat. (Seitenteil 2 cm Dicke). Lineares Modul 70 cm. Sitzhöhe H 75 cm.
- > Sistema de asientos múltiples. Asiento y respaldo tapizados. Base frente, trasera y lado (Lado esp.2 cm) en laminado. Módulo lineal L.70 cm. Altura asiento 75 cm.



768

- > Sistema sedute multiple. Sedile e schienale imbottiti. Fianco, zoccolo e retro in laminato (fianco sp.2 cm). Modulo angolare. Versione seduta H 75 cm.
- > Modular seating system. Upholstered seat and back. Laminate front, side and rear (side thickness 2 cm). Corner module. Backrest H 75 cm.
- > Banquettes multiples. Assise et dossier rembourrés, revêtement en tissu, plinthe joues et arrière en stratifié (ep. 2 cm). Module d'angle. Version hauteur assise 75 cm.
- > System aus mehreren Sitzmöbeln. Gepolsterte Sitzfläche und Rückenlehne. Seitenteil, Sockel und Hinten aus Laminat. (Seitenteil 2 cm Dicke). Eckiges Modul. Sitzhöhe H 75 cm.
- > Sistema de asientos múltiples. Asiento y respaldo tapizados. Base frente, trasera y lado (Lado esp.2 cm) en laminado. Módulo de esquina. Altura asiento 75 cm.

TE

- > Finiture seduta (vedi p. 359)
- > Seat finishes (see p. 359)
- > Finitions de l'assise (voir p. 359)
- > Sitzfertigung (sehen S. 359)
- > Acabados asiento (ver p. 359)

LAM

- > Finiture telaio (vedi p. 401)
- > Frame finishes (see p. 401)
- > Finitions piètement (voir p. 401)
- > Gestell fertigung (sehen S. 401)
- > Acabados estructura (ver p. 401)

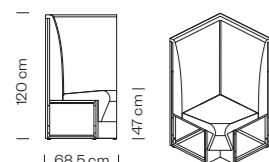

Peso / Weight / Poids / Gewicht / Peso **39 kg**

Imballo / Packaging / Emballage / Verpackung / Embalaje **0,69 m³**

Pezzi per scatola / Pieces per box / Pièces par carton / Stücke in einem Karton / Piezas por caja **1**

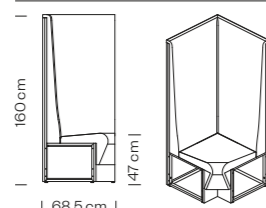

Peso / Weight / Poids / Gewicht / Peso **46 kg**

Imballo / Packaging / Emballage / Verpackung / Embalaje **0,91 m³**

Pezzi per scatola / Pieces per box / Pièces par carton / Stücke in einem Karton / Piezas por caja **1**

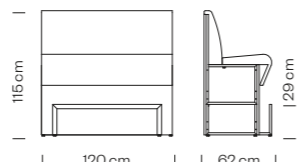

Peso / Weight / Poids / Gewicht / Peso **66 kg**

Imballo / Packaging / Emballage / Verpackung / Embalaje **1,09 m³**

Pezzi per scatola / Pieces per box / Pièces par carton / Stücke in einem Karton / Piezas por caja **1**

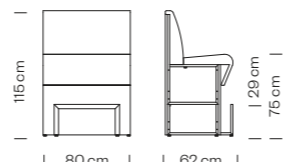

Peso / Weight / Poids / Gewicht / Peso **47 kg**

Imballo / Packaging / Emballage / Verpackung / Embalaje **0,76 m³**

Pezzi per scatola / Pieces per box / Pièces par carton / Stücke in einem Karton / Piezas por caja **1**

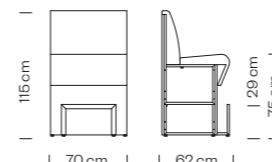

Peso / Weight / Poids / Gewicht / Peso **42 kg**

Imballo / Packaging / Emballage / Verpackung / Embalaje **0,63 m³**

Pezzi per scatola / Pieces per box / Pièces par carton / Stücke in einem Karton / Piezas por caja **1**

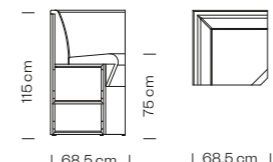

Peso / Weight / Poids / Gewicht / Peso **46 kg**

Imballo / Packaging / Emballage / Verpackung / Embalaje **0,64 m³**

Pezzi per scatola / Pieces per box / Pièces par carton / Stücke in einem Karton / Piezas por caja **1**



Accessori / Accessories / Accessoires / Zubehoer / Accesorios

- > Cuscini cilindrici
- > Tubular cushions
- > Coussins cylindriques
- > Kissen zylinder
- > Cojines cilindricos



001

design
rdm, 1956



276



001

- > Poltroncina con telaio 4 gambe in tubo acciaio con sedile e schienale in Xiloplast.
- > Armchair with 4 legs steel frame. Seat and back in Xiloplast.
- > Fauteuil avec châssis 4 pieds en acier, assise et dossier en Xiloplast.
- > Armlehnstuhl mit 4-beinigem Stahlgestell. Sitzfläche und Rückenlehne aus Xiloplast.
- > Sillón con estructura tubular 4 patas en acero, asiento y respaldo en xiloplast.

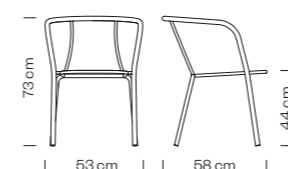

Peso / Weight / Poids / Gewicht / Peso **5,5 kg**

Imballo / Packaging / Emballage / Verpackung / Embalaje **0,32 m³**

Pezzi per scatola / Pieces per box / Pièces par carton / Stücke in einem Karton / Piezas por caja **4**

Impilabile / Stackable / Empilable / Stapelbar / Apilable **8**

277

XLP

- > Finiture seduta
- > Seat finishes
- > Finitions de l'assise
- > Sitzfertigung
- > Acabados asiento



AC

- > Finiture telaio (vedi p. 395)
- > Frame finishes (see p. 395)
- > Finitions piètement (voir p. 395)
- > Gestell fertigungen (sehen S. 395)
- > Acabados estructura (ver p. 395)

salinero

design
Giulio Iacchetti, 2018



1000

- > Tavolo con gambe in tubo acciaio e piano 100x100 in stratificato HPL. Gambe a filo piano.
- > Table with 4 steel legs and 100x100 HPL solid laminate top. Top's edge legs.
- > Table avec 4 pieds en acier et plateau 100x100 en stratifié HPL. Piètement à fleur du plateau.
- > Tisch mit 4-beinigem Stahlgestell und 100x100 HPL Compactplatte. Tischbeine sind bündig zur Tischplatte.
- > Pie de mesa 4 patas en acero y sobre 100x100 en estratificado HPL. Patas a ras del sobre.

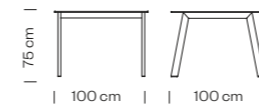

Peso / Weight / Poids / Gewicht / Peso
31,5 kg

Imballo / Packaging / Emballage / Verpackung / Embalaje
0,09+0,17 m³

Pezzi per scatola / Pieces per box / Pièces par carton / Stücke in einem Karton / Piezas por caja
1



1001

- > Tavolo con gambe in tubo acciaio e piano 200x100 in stratificato HPL. Gambe a filo piano.
- > Table with 4 steel legs and 200x100 HPL solid laminate top. Top's edge legs.
- > Table avec 4 pieds en acier et plateau 200x100 en stratifié HPL. Piètement à fleur du plateau.
- > Tisch mit 4-beinigem Stahlgestell und 200x100 HPL Compactplatte. Tischbeine sind bündig zur Tischplatte.
- > Pie de mesa 4 patas en acero y sobre 200x100 en estratificado HPL. Patas a ras del sobre.

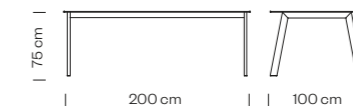

Peso / Weight / Poids / Gewicht / Peso
49,5 kg

Imballo / Packaging / Emballage / Verpackung / Embalaje
0,09+0,34 m³

Pezzi per scatola / Pieces per box / Pièces par carton / Stücke in einem Karton / Piezas por caja
1



1002

- > Tavolo con gambe in tubo acciaio e piano 240x100 in stratificato HPL. Gambe a filo piano.
- > Table with 4 steel legs and 240x100 HPL solid laminate top. Top's edge legs.
- > Table avec 4 pieds en acier et plateau 240x100 en stratifié HPL. Piètement à fleur du plateau.
- > Tisch mit 4-beinigem Stahlgestell und 240x100 HPL Compactplatte. Tischbeine sind bündig zur Tischplatte.
- > Pie de mesa 4 patas en acero y sobre 240x100 en estratificado HPL. Patas a ras del sobre.

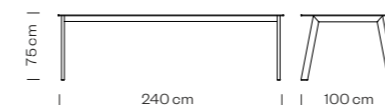

Peso / Weight / Poids / Gewicht / Peso
56,7 kg

Imballo / Packaging / Emballage / Verpackung / Embalaje
0,09+0,43 m³

Pezzi per scatola / Pieces per box / Pièces par carton / Stücke in einem Karton / Piezas por caja
1



1003

- > Tavolo con gambe in tubo acciaio e piano 300x100 in stratificato HPL. Gambe a filo piano.
- > Table with 4 steel legs and 300x100 HPL solid laminate top. Top's edge legs.
- > Table avec 4 pieds en acier et plateau 300x100 en stratifié HPL. Piètement à fleur du plateau.
- > Tisch mit 4-beinigem Stahlgestell und 300x100 HPL Compactplatte. Tischbeine sind bündig zur Tischplatte.
- > Pie de mesa 4 patas en acero y sobre 300x100 en estratificado HPL. Patas a ras del sobre.



Peso / Weight / Poids / Gewicht / Peso
68,2 kg

Imballo / Packaging / Emballage / Verpackung / Embalaje
0,09+0,53 m³

Pezzi per scatola / Pieces per box / Pièces par carton / Stücke in einem Karton / Piezas por caja
1



1004

- > Tavolo con gambe in tubo acciaio e piano 260x100 in stratificato HPL. Gambe posizionate internamente al piano.
 - > Table with 4 steel legs and 260x100 HPL solid laminate top. Recessed legs.
 - > Table avec 4 pieds en acier et plateau 260x100 en stratifié
- HPL. Piètement positionné sous le plateau.
 - > Tisch mit 4-beinigem Stahlgestell und 260x100 HPL Compactplatte. Tischplatte aussen bündig zu den Tischbeinen.
 - > Pie de mesa 4 patas en acero y sobre 260x100 en estratificado HPL. Patas por dentro del sobre.



Peso / Weight / Poids / Gewicht / Peso
58,1 kg

Imballo / Packaging / Emballage / Verpackung / Embalaje
0,09+0,46 m³

Pezzi per scatola / Pièces per box / Pièces par carton / Stücke in einem Karton / Piezas por caja
1



1005

- > Tavolo con gambe in tubo acciaio e piano 300x100 in stratificato HPL. Gambe posizionate internamente al piano.
 - > Table with 4 steel legs and 300x100 HPL solid laminate top. Recessed legs.
 - > Table avec 4 pieds en acier et plateau 300x100 en stratifié
- HPL. Piètement positionné sous le plateau.
 - > Tisch mit 4-beinigem Stahlgestell und 300x100 HPL Compactplatte. Tischplatte aussen bündig zu den Tischbeinen.
 - > Pie de mesa 4 patas en acero y sobre 300x100 en estratificado HPL. Patas por dentro del sobre.



Peso / Weight / Poids / Gewicht / Peso
66,7 kg

Imballo / Packaging / Emballage / Verpackung / Embalaje
0,09+0,53 m³

Pezzi per scatola / Pièces per box / Pièces par carton / Stücke in einem Karton / Piezas por caja
1



AC

- > Finiture telaio
- > Frame finishes
- > Finitions piètement
- > Gestell fertigungen
- > Acabados estructura



STR

- > Finiture piani tavoli
- > Table tops finishes
- > Finitions plateaux de table
- > Tischplattenfertigungen
- > Acabados por sobrees de mesas

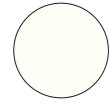

Full color



Compact
Nero /
Black / Noir /
Schwarz /
Negro
DS

Antimpronta /
Anti-fingerprints /
Anti-empreinte /
Anti Fingerabdrücke /
Antihuella /



Grafite /
Graphite/
Graphite /
Graphite /
Grafito



Fenix
NTM 0720
NERO INGO

Accessori / Accessories /
Accessoires / Zubehoer /
Accesorios

- > vedi p. 290
- > see p. 290
- > voir p. 290
- > sehen S. 290
- > ver p. 290



dalton

design
Giulio Iacchetti, 2016



614

- > Tavolo con fusto in frassino e piano in stratificato HPL.
- > Table with ash wood frame and HPL solid laminate top.
- > Table avec chassis en frêne et plateau en stratifié HPL.
- > Tisch mit Gestell aus Esche und HPL Compactplatte.
- > Mesa con estructura en madera de fresno y sobre en estratificado HPL.

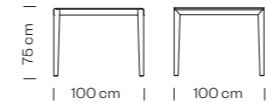

Peso / Weight / Poids / Gewicht / Peso
31 kg

Imballo / Packaging / Emballage / Verpackung / Embalaje
0,14+,014 m³

Pezzi per scatola / Pieces per box / Pièces par carton / Stücke in einem Karton / Piezas por caja
1



616

- > Tavolo con fusto in frassino e piano in stratificato HPL.
- > Table with ash wood frame and HPL solid laminate top.
- > Table avec chassis en frêne et plateau en stratifié HPL.
- > Tisch mit Gestell aus Esche und HPL Compactplatte.
- > Mesa con estructura en madera de fresno y sobre en estratificado HPL.



Peso / Weight / Poids / Gewicht / Peso
56,3 kg

Imballo / Packaging / Emballage / Verpackung / Embalaje
0,14+,033 m³

Pezzi per scatola / Pieces per box / Pièces par carton / Stücke in einem Karton / Piezas por caja
1



615

- > Tavolo con fusto in frassino e piano in stratificato HPL.
- > Table with ash wood frame and HPL solid laminate top.
- > Table avec chassis en frêne et plateau en stratifié HPL.
- > Tisch mit Gestell aus Esche und HPL Compactplatte.
- > Mesa con estructura en madera de fresno y sobre en estratificado HPL.

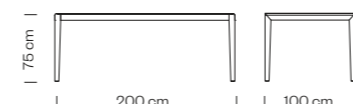

Peso / Weight / Poids / Gewicht / Peso
49,3 kg

Imballo / Packaging / Emballage / Verpackung / Embalaje
0,14+,027 m³

Pezzi per scatola / Pieces per box / Pièces par carton / Stücke in einem Karton / Piezas por caja
1



617

- > Tavolo con fusto in frassino e piano in stratificato HPL.
- > Table with ash wood frame and HPL solid laminate top.
- > Table avec chassis en frêne et plateau en stratifié HPL.
- > Tisch mit Gestell aus Esche und HPL Compactplatte.
- > Mesa con estructura en madera de fresno y sobre en estratificado HPL.



Peso / Weight / Poids / Gewicht / Peso
66,8 kg

Imballo / Packaging / Emballage / Verpackung / Embalaje
0,14+,041 m³

Pezzi per scatola / Pieces per box / Pièces par carton / Stücke in einem Karton / Piezas por caja
1

LE

- > Finiture telaio
- > Frame finishes
- > Finitions piètement
- > Gestell fertigungen
- > Acabados estructura



STR

- > Finiture piani tavoli
- > Table tops finishes
- > Finitions plateaux de table
- > Tischplattenfertigungen
- > Acabados por sobrees de mesas



Full color

Compact
Nero / Black /
Noir / Schwarz /
Negro
DS

Antimpronta /
Anti-fingerprints /
Anti-empreinte /
Anti Fingerabdrücke /
Antihuella /



Grafito /
Graphite /
Graphite /
Graphite / Grafito

Fenix
NTM 0720
NERO INGO

Accessori / Accessories /
Accessoires / Zubehoer /
Accesorios

- > vedi p. 290
- > see p. 290
- > voir p. 290
- > sehen S. 290
- > ver p. 290





accessori / accessories / accessoires / zubehoer / accessorios

per / for /
pour / für / por
salinero, dalton



A

- > Dispositivo di alimentazione. Presa elettrica e USB.
- > Power supply device. Electric socket and USB.
- > Système d'alimentation. Prise électrique et USB.
- > Integrierte Steckdose/Usb. Dispositivo de suministro de energía. Toma de corriente y USB.

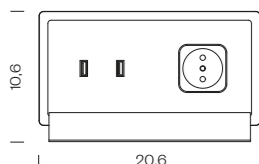

B

- > Dispositivo di ricarica wireless a scomparsa per smartphone dotati di ricevitore Qi o con opportuno adattatore o cover o pellicola per batteria.
- > Retractable wireless charging device for smartphones equipped with Qi wireless receiver or with appropriate adapter or cover or film for battery.
- > Chargeur rétractable sans fil pour mobiles multifonction équipés d'un récepteur Qi ou avec un adaptateur ou un cache approprié ou un film pour batterie.
- > Integriertes, drahtloses Ladegerät für Smartphones, die mit einem Qi-Empfänger, einem geeigneten Adapter oder einer entsprechenden Abdeckung oder Folie für den Akku ausgestattet sind.
- > Dispositivo de carga sin hilos retráctil para teléfonos inteligentes equipados con receptor Qi ó con el adaptador ó cubierta ó película adecuados para la batería.



C

- > Asola su piano con canalina raccolta cavi.
- > Buttonhole on top with cable collection channel.
- > Boucle sur plateau avec gouttière pour câble.
- > Kabelauslass Tischplatte. Ojal sobre mesa con guía para contener cables.

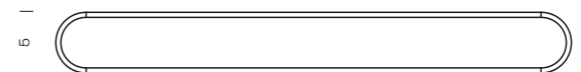

D

- > Vertebra passacavi scrivania/pavimento.
- > Cable guide for desk/floor.
- > Goulotte passe-câbles bureau/sol.
- > Kabelspirale/Kanal. Guía pasacables escritorio/suelo.

**Accessori / Accessories /
Accessoires / Zubehoer /
Accesorios**

- > I tavoli Salinero e Dalton possono essere accessoriati nel seguente modo:
- > The Salinero and Dalton tables can be equipped as follows:
- > Les tables Salinero et Dalton peuvent être équipés comme suit:
- > Die Tische Salinero und Dalton können die folgenden Zubehöre haben:
- > Las mesas Salinero y Dalton se pueden equipar según las combinaciones a continuación:

A (+D)

B (+D)

C (+D)

AB (+D)

BC (+D)

- > L'accessorio D può essere inserito in ogni combinazione, gli accessori A e C non sono tra loro compatibili.
- > The accessory D can be inserted in any combination. Accessories A and C are not compatible with each other.
- > L'accessoire D peut être inséré dans toutes les combinaisons, les accessoires A et C ne sont pas compatibles.
- > Das Zubehör D kann in jeder Kombination eingesetzt werden, die Zubehörteile A und C sind nicht miteinander kompatibel.
- > El accesorio D se puede insertar en todas las combinaciones, los accesorios A y C no son compatibles entre si.

Salinero

Combinazioni disponibili / Available combinations /
Disponibles /
Combinaisons disponibles /
Verfügbare Kombination /
Combinaciones disponibles

1001 AB

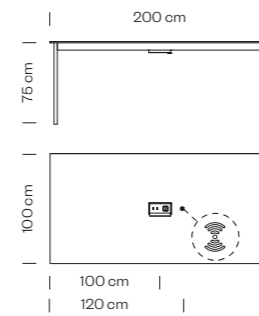

1003 BC

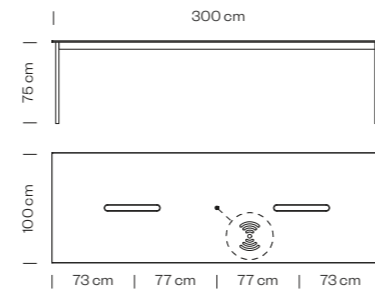

1001 BC

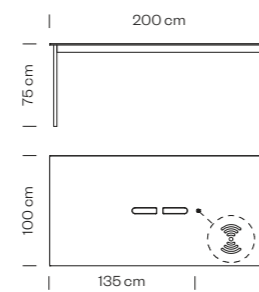

1004 AB

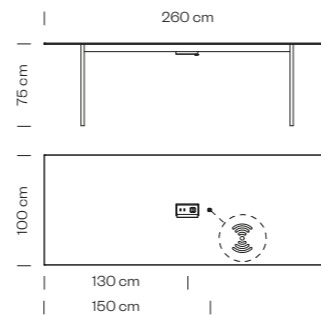

1002 AB

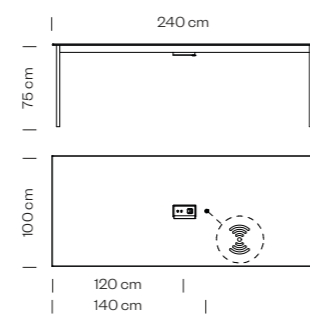

1004 BC

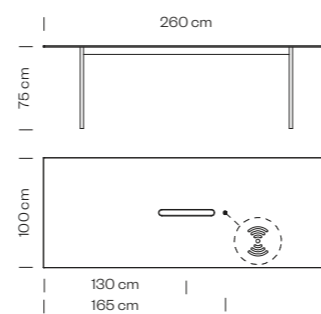

1002 BC

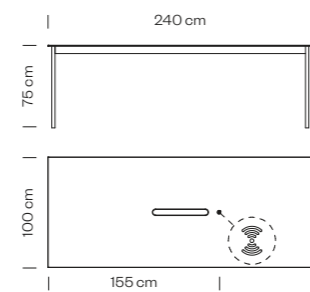

1005 AB

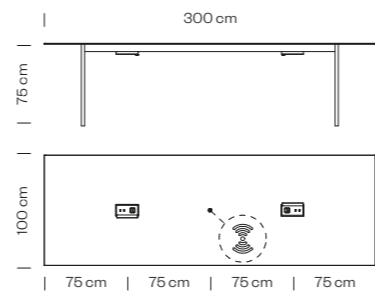

1003 AB

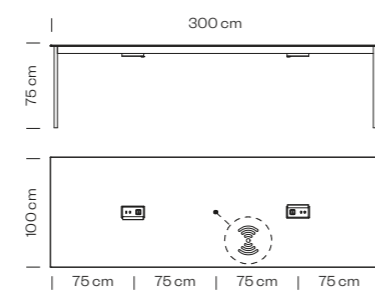

1005 BC

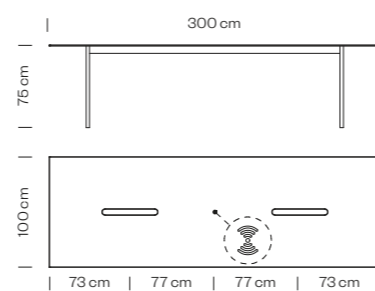

Dalton

Combinazioni disponibili / Available combinations /
Disponibles /
Combinaisons disponibles /
Verfügbare Kombination /
Combinaciones disponibles

615 AB

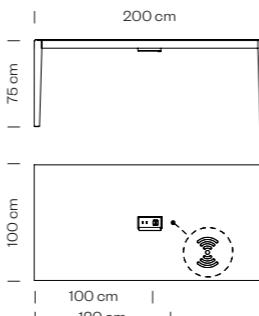

615 BC

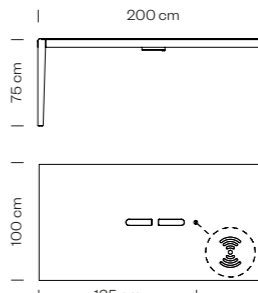

616 AB

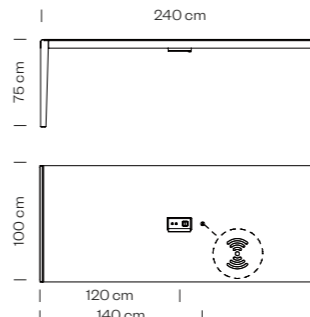

617 AB

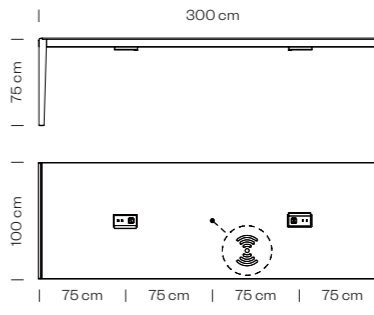

616 BC

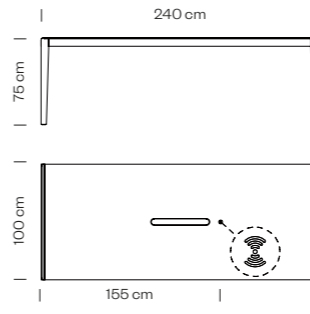

617 BC

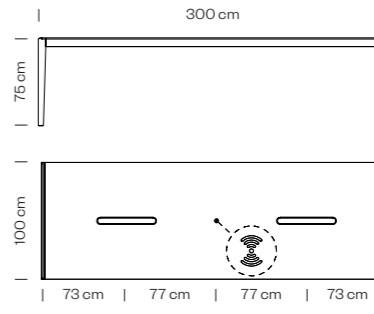



521Q

- > Tavolo con telaio 4 gambe in tubo acciaio. H 35 cm.
- > Coffee table with 4 steel legs. Height 35 cm.
- > Table avec 4 pieds en acier. Hauteur 35 cm.
- > Tisch mit 4-beinigem Stahlgestell. Höhe 35 cm.
- > Pie de mesa 4 patas en acero. Altura 35 cm.

Piani Tavolo / Table Tops /
Plateaux De Table / Tischplatten /
Sobres De Mesa
Ø 60 cm
60x60 cm

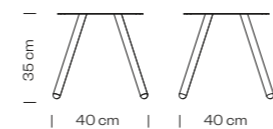

Peso / Weight /
Poids / Gewicht / Peso **4,2 kg**

Imballo / Packaging /
Emballage / Verpackung /
Embalaje **0,22 m³**

Pezzi per scatola /
Pieces per box /
Pièces par carton /
Stücke in einem Karton /
Piezas por caja **2**



521T

- > Tavolo con telaio 3 gambe in tubo acciaio. H 35 cm.
- > Coffee table with 3 steel legs. Height 35 cm.
- > Table avec 3 pieds en acier. Hauteur 35 cm.
- > Tisch mit 3-beinigem Stahlgestell. Höhe 35 cm.
- > Pie de mesa 3 patas en acero. Altura 35 cm.

Piani Tavolo / Table Tops /
Plateaux De Table / Tischplatten /
Sobres De Mesa
Ø 60 cm

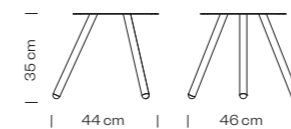

Peso / Weight /
Poids / Gewicht / Peso **3,9 kg**

Imballo / Packaging /
Emballage / Verpackung /
Embalaje **0,22 m³**

Pezzi per scatola /
Pieces per box /
Pièces par carton /
Stücke in einem Karton /
Piezas por caja **2**



522Q

- > Tavolo con telaio 4 gambe in faggio. H 35 cm.
- > Coffee table with 4 beech wood legs. Height 35 cm.
- > Table avec 4 pieds en hêtre. Hauteur 35 cm.
- > Tisch mit 4-beinigem Buchenholzgestell. Höhe 35 cm.
- > Pie de mesa 4 patas en madera de haya. Altura 35 cm.

Piani Tavolo / Table Tops /
Plateaux De Table / Tischplatten /
Sobres De Mesa
Ø 60 cm
60x60 cm

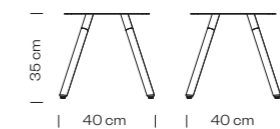

Peso / Weight /
Poids / Gewicht / Peso **3,7 kg**

Imballo / Packaging /
Emballage / Verpackung /
Embalaje **0,22 m³**

Pezzi per scatola /
Pieces per box /
Pièces par carton /
Stücke in einem Karton /
Piezas por caja **2**



522T

- > Tavolo con telaio 3 gambe in faggio. H 35 cm.
- > Coffee table with 3 beech wood legs. Height 35 cm.
- > Table avec 3 pieds en hêtre. Hauteur 35 cm.
- > Tisch mit 3-beinigem Buchenholzgestell. Höhe 35 cm.
- > Pie de mesa 3 patas en madera de haya. Altura 35 cm.

Piani Tavolo / Table Tops /
Plateaux De Table / Tischplatten /
Sobres De Mesa
Ø 60 cm

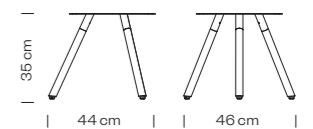

Peso / Weight /
Poids / Gewicht / Peso **3,5 kg**

Imballo / Packaging /
Emballage / Verpackung /
Embalaje **0,22 m³**

Pezzi per scatola /
Pieces per box /
Pièces par carton /
Stücke in einem Karton /
Piezas por caja **2**



523Q

- > Tavolo con telaio 4 gambe in tubo acciaio. H 50 cm.
- > Coffee table with 4 steel legs. Height 50 cm.
- > Table avec 4 pieds en acier. Hauteur 50 cm.
- > Tisch mit 4-beinigem Stahlgestell. Höhe 50 cm.
- > Pie de mesa 4 patas en acero. Altura 50 cm.

Piani Tavolo / Table Tops /
Plateaux De Table / Tischplatten /
Sobres De Mesa
Ø 60 cm
60x60 cm

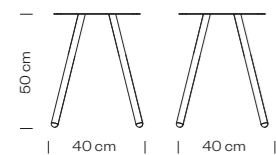

Peso / Weight /
Poids / Gewicht / Peso **5,2 kg**

Imballo / Packaging /
Emballage / Verpackung /
Embalaje **0,29 m³**

Pezzi per scatola /
Pieces per box /
Pièces par carton /
Stücke in einem Karton /
Piezas por caja **2**



524Q

- > Tavolo con telaio 4 gambe in faggio. H 50 cm.
- > Coffee table with 4 beech wood legs. Height 50 cm.
- > Table avec 4 pieds en hêtre. Hauteur 50 cm.
- > Tisch mit 4-beinigem Buchenholzgestell. Höhe 50 cm.
- > Pie de mesa 4 patas en madera de haya. Altura 50 cm.

Piani Tavolo / Table Tops /
Plateaux De Table / Tischplatten /
Sobres De Mesa
Ø 60 cm
60x60 cm

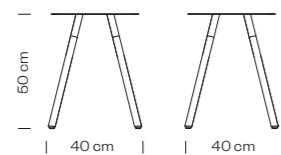

Peso / Weight /
Poids / Gewicht / Peso **5,1 kg**

Imballo / Packaging /
Emballage / Verpackung /
Embalaje **0,29 m³**

Pezzi per scatola /
Pieces per box /
Pièces par carton /
Stücke in einem Karton /
Piezas por caja **2**



525Q

- > Tavolo con telaio 4 gambe in tubo acciaio. H 72 cm.
- > Coffee table with 4 steel legs. Height 72 cm.
- > Table avec 4 pieds en acier. Hauteur 72 cm.
- > Tisch mit 4-beinigem Stahlgestell. Höhe 72 cm.
- > Pie de mesa 4 patas en acero. Altura 72 cm.

Piani Tavolo / Table Tops /
Plateaux De Table / Tischplatten /
Sobres De Mesa
Ø 60 cm
60x60 cm
Ø 70 cm
70x70 cm

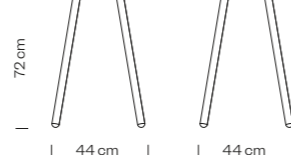

Peso / Weight /
Poids / Gewicht / Peso **6,6 kg**

Imballo / Packaging /
Emballage / Verpackung /
Embalaje **0,22 m³**

Pezzi per scatola /
Pieces per box /
Pièces par carton /
Stücke in einem Karton /
Piezas por caja **2**



526Q

- > Tavolo con telaio 4 gambe in tubo faggio. H 72 cm.
- > Coffee table with 4 beech wood legs. Height 72 cm.
- > Table avec 4 pieds en hêtre. Hauteur 72 cm.
- > Tisch mit 4-beinigem Buchenholzgestell. Höhe 72 cm.
- > Pie de mesa 4 patas en madera de haya. Altura 72 cm.

Piani Tavolo / Table Tops /
Plateaux De Table / Tischplatten /
Sobres De Mesa
Ø 60 cm
60x60 cm
Ø 70 cm
70x70 cm

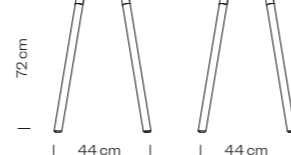

Peso / Weight /
Poids / Gewicht / Peso **5,7 kg**

Imballo / Packaging /
Emballage / Verpackung /
Embalaje **0,22 m³**

Pezzi per scatola /
Pieces per box /
Pièces par carton /
Stücke in einem Karton /
Piezas por caja **2**

AC

- > Finiture telaio (vedi p. 395)
- > Frame finishes (see p. 395)
- > Finitions piètement (voir p. 395)
- > Gestell fertigungen (sehen S. 395)
- > Acabados estructura (ver p. 395)

LE

- > Finiture telaio
- > Frame finishes
- > Finitions piètement
- > Gestell fertigungen
- > Acabados estructura

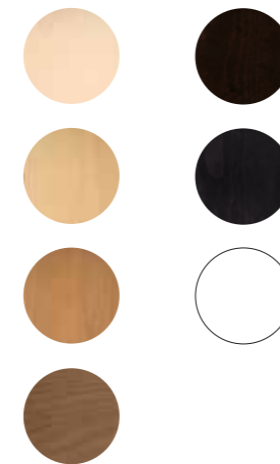



ex

design
rdm, 2016



300



517

- > Tavolo con basamento in lamiera acciaio stampata, colonna in tubo alluminio.
- > Table frame with moulded steel base and aluminium column.
- > Pied de table avec embase en tôle moulée, colonne en aluminium.
- > Gestell mit Säule aus extrudiertem Aluminium und gepresster Bodenplatte aus Stahl.
- > Pie de mesa con base en plancha de acero moldeada, columna en aluminio.

Piani Tavolo / Table Tops /
Plateaux De Table / Tischplatten /
Sobres De Mesa
Ø 60 cm
Ø 70 cm
60x60 cm
70x70 cm



Peso / Weight /
Poids / Gewicht / Peso **9,6 kg**

Imballo / Packaging /
Emballage / Verpackung /
Embalaje **0,06 m³**

Pezzi per scatola /
Pieces per box /
Pièces par carton /
Stücke in einem Karton /
Piezas por caja **2**



517R

- > Tavolo con basamento in lamiera acciaio stampata, colonna in tubo alluminio e piano ribaltabile.
- > Folding table frame with moulded steel base and aluminium column.
- > Pied de table avec embase en tôle moulée, colonne en aluminium et système de plateau rabattable.
- > Gestell mit Säule aus extrudiertem Aluminium, gepresster Bodenplatte aus Stahl und Klappbarsystem.
- > Pie de mesa con base en plancha de acero moldeada, columna en aluminio y sobre abatible.

Piani Tavolo / Table Tops /
Plateaux De Table / Tischplatten /
Sobres De Mesa
Ø 60 cm
Ø 70 cm
60x60 cm
70x70 cm

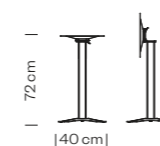

Peso / Weight /
Poids / Gewicht / Peso **9,5 kg**

Imballo / Packaging /
Emballage / Verpackung /
Embalaje **0,06 m³**

Pezzi per scatola /
Pieces per box /
Pièces par carton /
Stücke in einem Karton /
Piezas por caja **2**



AC

- > Finiture telaio (vedi p. 395)
- > Frame finishes (see p. 395)
- > Finitions piètement (voir p. 395)
- > Gestell fertigungen (sehen S. 395)
- > Acabados estructura (ver p. 395)

AL VR

- > Finiture telaio (vedi p. 398)
- > Frame finishes (see p. 398)
- > Finitions piètement (voir p. 398)
- > Gestell fertigungen (sehen S. 398)
- > Acabados estructura (ver p. 398)



Accessori / Accessories /
Accessoires / Zubehoer /
Accessorios

Piedini Regolabili H 12 mm /
H 12 mm adjustable feet /
Vérins réglables H 12 mm /
Verstellgleitern H. 12 mm /
Pies niveladores H 12 mm

301

design
rdm, 2016



520

- > Tavolo con telaio in tubo acciaio.
- > Table with steel frame.
- > Pied de table avec châssis en acier.
- > Tisch mit Stahlrohrgestell.
- > Pie de mesa en acero.

Piani Tavolo / Table Tops /
Plateaux De Table / Tischplatten /
Sobres De Mesa
Ø 60 cm
60x60 cm

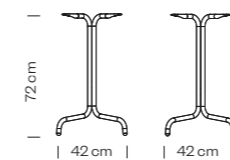

Peso / Weight /
Poids / Gewicht / Peso **3,5 kg**

Imballo / Packaging /
Emballage / Verpackung /
Embalaje **0,09 m³**

Pezzi per scatola /
Pieces per box /
Pièces par carton /
Stücke in einem Karton /
Piezas por caja **2**

AC

- > Finiture telaio
(vedi p. 395)
- > Frame finishes
(see p. 395)
- > Finitions piètement
(voir p. 395)
- > Gestell fertigungen
(sehen S. 395)
- > Acabados estructura
(ver p. 395)



mx

design
rdm, 2016



518

- > Tavolo con telaio alluminio anodizzato lucido o verniciato, impilabile.
- > Table with glossy or powder coated anodised aluminium frame, stackable.
- > Pied de table en aluminium anodisé brillant ou verni, empilable.
- > Tischgestell aus eloxiertes Aluminium glanzend oder lackiert, Stapelbar.
- > Pie de mesa en aluminio anodizado pulido o barnizado, apilable.

Piani Tavolo / Table Tops /
Plateaux De Table / Tischplatten /
Sobres De Mesa
Ø 60 cm
60x60 cm

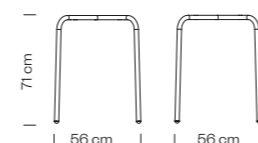

Peso / Weight /
Poids / Gewicht / Peso **1,8 kg**

Imballo / Packaging /
Emballage / Verpackung /
Embalaje **0,39 m³**

Pezzi per scatola /
Pieces per box /
Pièces par carton /
Stücke in einem Karton /
Piezas por caja **4**

Impilabile / Stackable /
Empilable /
Stapelbar / Apilable **4**

AL AND

- > Finiture telaio
- > Frame finishes
- > Finitions piètement
- > Gestell fertigungen
- > Acabados estructura



AL VR

- > Finiture telaio (vedi p. 398)
- > Frame finishes (see p. 398)
- > Finitions piètement (voir p. 398)
- > Gestell fertigungen (sehen S. 398)
- > Acabados estructura (ver p. 398)



nx

design
rdm, 2016



306



519

- > Tavolo con telaio in tubo acciaio, impilabile.
- > Table with steel frame; stackable.
- > Pied de table en acier, empilable.
- > Tisch mit Stahlgestell, Stapelbar.
- > Pie de mesa en acero, apilable.

Piani Tavolo / Table Tops /
Plateaux De Table / Tischplatten /
Sobres De Mesa
Ø 60 cm
60x60 cm



Peso / Weight /
Poids / Gewicht / Peso **3,3 kg**

Imballo / Packaging /
Emballage / Verpackung /
Embalaje **0,39 m³**

Pezzi per scatola /
Pieces per box /
Pièces par carton /
Stücke in einem Karton /
Piezas por caja **4**

Impilabile / Stackable /
Empilable /
Stapelbar / Apilable **4**

307

AC

- > Finiture telaio
(vedi p. 395)
- > Frame finishes
(see p. 395)
- > Finitions piètement
(voir p. 395)
- > Gestell fertigungen
(sehen S. 395)
- > Acabados estructura
(ver p. 395)



ax

design
rdm, 2015



308



511

- > Tavolo con basamento in lamiera acciaio stampata, colonna in alluminio.
- > Table frame with moulded steel base and aluminium column.
- > Châssis avec embase en acier moulé et colonne en aluminium.
- > Tischgestell mit Säule aus extrudiertem Aluminium und gepresster Bodenplatte aus Stahl.
- > Pie de mesa con base en plancha de acero moldeada, columna en aluminio.

Piani Tavolo / Table Tops /
Plateaux De Table / Tischplatten /
Sobres De Mesa
Ø 60 cm
Ø 70 cm
Ø 80 cm
Ø 90 cm
Ø 100 cm
60x60 cm
70x70 cm
80x80 cm



511A

- > Tavolo alto con basamento in lamiera acciaio stampata, colonna in alluminio.
- > High table frame with moulded steel base and aluminium column.
- > Châssis avec embase en acier moulé et colonne en aluminium, version mange debout.
- > Stehtischgestell mit Säule aus extrudiertem Aluminium und gepresster Bodenplatte aus Stahl.
- > Pie de mesa con base en plancha de acero moldeada, columna en aluminio. Mesa alta.

Piani Tavolo / Table Tops /
Plateaux De Table / Tischplatten /
Sobres De Mesa
Ø 60 cm
Ø 70 cm
60x60 cm
70x70 cm



512

- > Tavolo con basamento in lamiera acciaio stampata, colonna in alluminio.
- > Table frame with moulded steel base and aluminium column.
- > Châssis avec embase en acier moulé et colonne en aluminium.
- > Tischgestell mit Säule aus extrudiertem Aluminium und gepresster Bodenplatte aus Stahl.
- > Pie de mesa con base en plancha de acero moldeada, columna en aluminio.

Piani Tavolo / Table Tops /
Plateaux De Table / Tischplatten /
Sobres De Mesa
Ø 100 cm
Ø 60 cm
80x80 cm
90x90 cm



512A

- > Tavolo alto con basamento in lamiera acciaio stampata, colonna in alluminio.
- > High table frame with moulded steel base and aluminium column.
- > Châssis avec embase en acier moulé et colonne en aluminium, version mange debout.
- > Stehtischgestell mit Säule aus extrudiertem Aluminium und gepresster Bodenplatte aus Stahl.
- > Pie de mesa con base en plancha de acero moldeada, columna en aluminio. Mesa alta.

Piani Tavolo / Table Tops /
Plateaux De Table / Tischplatten /
Sobres De Mesa
Ø 80 cm
80x80 cm



Peso / Weight /
Poids / Gewicht / Peso **13,6 kg**

Imballo / Packaging /
Emballage / Verpackung /
Embalaje **0,06 m³**

Pezzi per scatola /
Pieces per box /
Pièces par carton /
Stücke in einem Karton /
Piezas por caja **2**

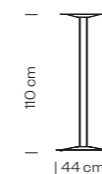

Peso / Weight /
Poids / Gewicht / Peso **14,1 kg**

Imballo / Packaging /
Emballage / Verpackung /
Embalaje **0,06 m³**

Pezzi per scatola /
Pieces per box /
Pièces par carton /
Stücke in einem Karton /
Piezas por caja **2**

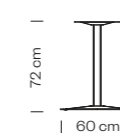

Peso / Weight /
Poids / Gewicht / Peso **21,2 kg**

Imballo / Packaging /
Emballage / Verpackung /
Embalaje **0,07 m³**

Pezzi per scatola /
Pieces per box /
Pièces par carton /
Stücke in einem Karton /
Piezas por caja **1**

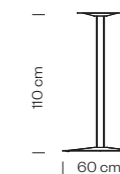

Peso / Weight /
Poids / Gewicht / Peso **21,7 kg**

Imballo / Packaging /
Emballage / Verpackung /
Embalaje **0,07 m³**

Pezzi per scatola /
Pieces per box /
Pièces par carton /
Stücke in einem Karton /
Piezas por caja **1**

309



513

- > Tavolo con basamento in lamiera acciaio stampata, colonna in alluminio.
- > Table frame with moulded steel base and aluminium column.
- > Châssis avec embase en acier moulé et colonne en aluminium.
- > Tischgestell mit Säule aus extrudiertem Aluminium und gepresster Bodenplatte aus Stahl.
- > Pie de mesa con base en plancha de acero moldeada, columna en aluminio.

Piani Tavolo / Table Tops /
Plateaux De Table / Tischplatten /
Sobres De Mesa
Ø 120 cm
Ø 130 cm
Ø 140 cm
Ø 150 cm
100x100 cm
110x110 cm

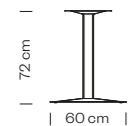

Peso / Weight /
Poids / Gewicht / Peso **22 kg**

Imballo / Packaging /
Emballage / Verpackung /
Embalaje **0,07 m³**

Pezzi per scatola /
Pieces per box /
Pièces par carton /
Stücke in einem Karton /
Piezas por caja **1**



514

- > Tavolo con basamento in lamiera acciaio stampata, colonna in alluminio.
- > Table frame with moulded steel base and aluminium column.
- > Châssis avec embase en acier moulé et colonne en aluminium.
- > Tischgestell mit Säule aus extrudiertem Aluminium und gepresster Bodenplatte aus Stahl.
- > Pie de mesa con base en plancha de acero moldeada, columna en aluminio.

Piani Tavolo / Table Tops /
Plateaux De Table / Tischplatten /
Sobres De Mesa
60x100 cm
60x110 cm
60x120 cm
70x110 cm
70x120 cm
70x130 cm
80x120 cm
80x130 cm
80x140 cm

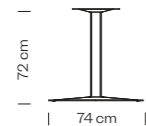

Peso / Weight /
Poids / Gewicht / Peso **18,7 kg**

Imballo / Packaging /
Emballage / Verpackung /
Embalaje **0,06 m³**

Pezzi per scatola /
Pieces per box /
Pièces par carton /
Stücke in einem Karton /
Piezas por caja **1**



AC

- > Finiture telaio (vedi p. 395)
- > Frame finishes (see p. 395)
- > Finitions piètement (voir p. 395)
- > Gestell fertigungen (sehen S. 395)
- > Acabados estructura (ver p. 395)

AL VR

- > Finiture telaio (vedi p. 398)
- > Frame finishes (see p. 398)
- > Finitions piètement (voir p. 398)
- > Gestell fertigungen (sehen S. 398)
- > Acabados estructura (ver p. 398)



**Accessori / Accessories /
Accessoires / Zubehoer /
Accesorios**

Versione per esterno /
Outdoor version /
Version pour extérieur /
Ausführung für den Außenbereich /
Version para exteriores

**Accessori / Accessories /
Accessoires / Zubehoer /
Accesorios**

Piedini Regolabili H 12 mm /
H 12 mm adjustable feet /
Vérins réglables H 12 mm /
Verstellgleitern H. 12 mm /
Pies niveladores H 12 mm



deck

design
rdm, 2012



312

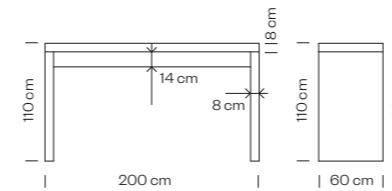

501A

- > Tavolo in tamburato con rivestimento in laminato. Versione prof. 60 cm.
- > Table in honeycomb board, with laminated surface. Version 60 cm depth.
- > Table mange debout en bois alvéolaire contreplaqué en stratifié. Versione profondeur 60 cm.
- > Tisch aus Holz mit Wabeneinlage und Verkleidung aus Laminat. Tiefe 60 cm.
- > Mesa en tamburado de madera con revestimiento en laminado. Profundidad 60 cm.

Peso / Weight / Poids / Gewicht / Peso **53 kg**

Imballo / Packaging / Emballage / Verpackung / Embalaje
0,11 m³ + 0,11 m³ + 0,24 m³ + 0,08 m³

Pezzi per scatola / Pieces per box / Pièces par carton / Stücke in einem Karton / Piezas por caja **1**

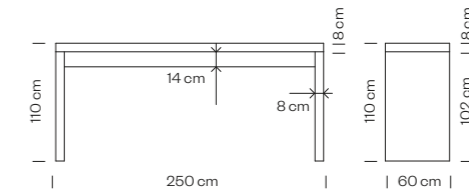

501B

- > Tavolo in tamburato con rivestimento in laminato. Versione prof. 60 cm.
- > Table in honeycomb board, with laminated surface. Version 60 cm depth.
- > Table mange debout en bois alvéolaire contreplaqué en stratifié. Versione profondeur 60 cm.
- > Tisch aus Holz mit Wabeneinlage und Verkleidung aus Laminat. Tiefe 60 cm.
- > Mesa en tamburado de madera con revestimiento en laminado. Profundidad 60 cm.

Peso / Weight / Poids / Gewicht / Peso **59 kg**

Imballo / Packaging / Emballage / Verpackung / Embalaje
0,11 m³ + 0,11 m³ + 0,29 m³ + 0,10 m³

Pezzi per scatola / Pieces per box / Pièces par carton / Stücke in einem Karton / Piezas por caja **1**

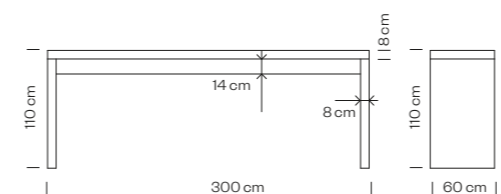

501C

- > Tavolo in tamburato con rivestimento in laminato. Versione prof. 60 cm.
- > Table in honeycomb board, with laminated surface. Version 60 cm depth.
- > Table mange debout en bois alvéolaire contreplaqué en stratifié. Versione profondeur 60 cm.
- > Tisch aus Holz mit Wabeneinlage und Verkleidung aus Laminat. Tiefe 60 cm.
- > Mesa en tamburado de madera con revestimiento en laminado. Profundidad 60 cm.

Peso / Weight / Poids / Gewicht / Peso **66 kg**

Imballo / Packaging / Emballage / Verpackung / Embalaje
0,11 m³ + 0,11 m³ + 0,35 m³ + 0,12 m³

Pezzi per scatola / Pieces per box / Pièces par carton / Stücke in einem Karton / Piezas por caja **1**



313

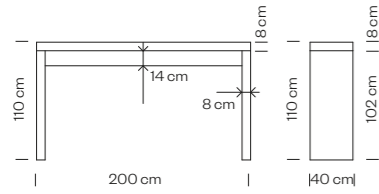

502A

- > Tavolo in tamburato con rivestimento in laminato. Versione prof. 40 cm.
- > Table in honeycomb board, with laminated surface. Version 40 cm depth.
- > Table mange debout en bois alvéolaire contreplaqué en stratifié. Versione profondeur 40 cm.
- > Tisch aus Holz mit Wabeneinlage und Verkleidung aus Laminat. Tiefe 40 cm.
- > Mesa en tamburado de madera con revestimiento en laminado. Profundidad 40 cm.

Peso / Weight / Poids / Gewicht / Peso **35 kg**

Imballo / Packaging / Emballage / Verpackung / Embalaje
0,08 m³ + 0,08 m³ + 0,18 m³ + 0,08 m³

Pezzi per scatola / Pieces per box / Pièces par carton / Stücke in einem Karton / Piezas por caja **1**

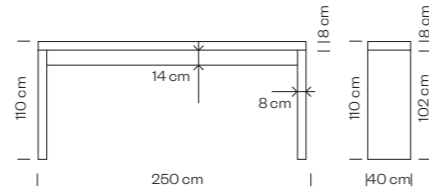

502B

- > Tavolo in tamburato con rivestimento in laminato. Versione prof. 40 cm.
- > Table in honeycomb board, with laminated surface. Version 40 cm depth.
- > Table mange debout en bois alvéolaire contreplaqué en stratifié. Versione profondeur 40 cm.
- > Tisch aus Holz mit Wabeneinlage und Verkleidung aus Laminat. Tiefe 40 cm.
- > Mesa en tamburado de madera con revestimiento en laminado. Profundidad 40 cm.

Peso / Weight / Poids / Gewicht / Peso **39 kg**

Imballo / Packaging / Emballage / Verpackung / Embalaje
0,08 m³ + 0,08 m³ + 0,21 m³ + 0,10 m³

Pezzi per scatola / Pieces per box / Pièces par carton / Stücke in einem Karton / Piezas por caja **1**

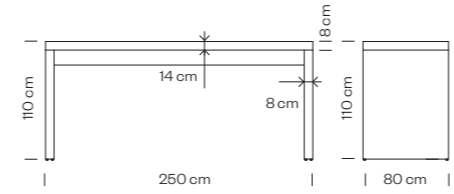

503B

- > Tavolo in tamburato con rivestimento in laminato. Versione prof. 80 cm.
- > Table in honeycomb board, with laminated surface. Version 80 cm depth.
- > Table mange debout en bois alvéolaire contreplaqué en stratifié. Versione profondeur 80 cm.
- > Tisch aus Holz mit Wabeneinlage und Verkleidung aus Laminat. Tiefe 80 cm.
- > Mesa en tamburado de madera con revestimiento en laminado. Profundidad 80 cm.

Peso / Weight / Poids / Gewicht / Peso **78 kg**

Imballo / Packaging / Emballage / Verpackung / Embalaje
0,15 m³ + 0,15 m³ + 0,37 m³ + 0,10 m³

Pezzi per scatola / Pieces per box / Pièces par carton / Stücke in einem Karton / Piezas por caja **1**

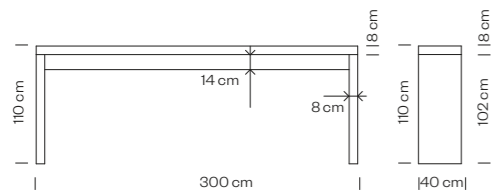

502C

- > Tavolo in tamburato con rivestimento in laminato. Versione prof. 40 cm.
- > Table in honeycomb board, with laminated surface. Version 40 cm depth.
- > Table mange debout en bois alvéolaire contreplaqué en stratifié. Versione profondeur 40 cm.
- > Tisch aus Holz mit Wabeneinlage und Verkleidung aus Laminat. Tiefe 40 cm.
- > Mesa en tamburado de madera con revestimiento en laminado. Profundidad 40 cm.

Peso / Weight / Poids / Gewicht / Peso **42 kg**

Imballo / Packaging / Emballage / Verpackung / Embalaje
0,08 m³ + 0,08 m³ + 0,25 m³ + 0,12 m³

Pezzi per scatola / Pieces per box / Pièces par carton / Stücke in einem Karton / Piezas por caja **1**

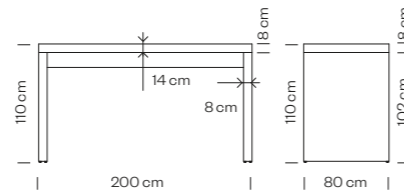

503A

- > Tavolo in tamburato con rivestimento in laminato. Versione prof. 80 cm.
- > Table in honeycomb board, with laminated surface. Version 80 cm depth.
- > Table mange debout en bois alvéolaire contreplaqué en stratifié. Versione profondeur 80 cm.
- > Tisch aus Holz mit Wabeneinlage und Verkleidung aus Laminat. Tiefe 80 cm.
- > Mesa en tamburado de madera con revestimiento en laminado. Profundidad 80 cm.

Peso / Weight / Poids / Gewicht / Peso **70 kg**

Imballo / Packaging / Emballage / Verpackung / Embalaje
0,15 m³ + 0,15 m³ + 0,31 m³ + 0,08 m³

Pezzi per scatola / Pieces per box / Pièces par carton / Stücke in einem Karton / Piezas por caja **1**

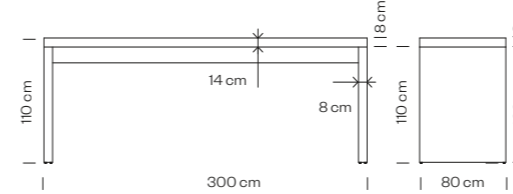

503C

- > Tavolo in tamburato con rivestimento in laminato. Versione prof. 80 cm.
- > Table in honeycomb board, with laminated surface. Version 80 cm depth.
- > Table mange debout en bois alvéolaire contreplaqué en stratifié. Versione profondeur 80 cm.
- > Tisch aus Holz mit Wabeneinlage und Verkleidung aus Laminat. Tiefe 80 cm.
- > Mesa en tamburado de madera con revestimiento en laminado. Profundidad 80 cm.

Peso / Weight / Poids / Gewicht / Peso **85 kg**

Imballo / Packaging / Emballage / Verpackung / Embalaje
0,15 m³ + 0,15 m³ + 0,44 m³ + 0,12 m³

Pezzi per scatola / Pieces per box / Pièces par carton / Stücke in einem Karton / Piezas por caja **1**

LAM

- > Finiture telaio (vedi p. 401)
- > Frame finishes (see p. 401)
- > Finitions piètement (voir p. 401)
- > Gestell fertigungen (sehen S. 401)
- > Acabados estructura (ver p. 401)

web

design
rdm, 2012



316



466

- > Tavolo con telaio in tubo acciaio, piedini regolabili.
- > Table frame in painted steel, with adjustable feet.
- > Pied de table en acier, avec vérins réglables.
- > Tisch mit Gestell aus Stahlrohren mit Verstellgleitern.
- > Pie de mesa en acero, con pies niveladores.

Piani Tavolo / Table Tops /
Plateaux De Table / Tischplatten /
Sobres De Mesa
Ø 60 cm
Ø 70 cm
Ø 80 cm
60x60 cm
70x70 cm



466A

- > Tavolo alto con telaio in tubo acciaio, piedini regolabili.
- > High table frame in painted steel, with adjustable feet.
- > Pied mange debout en acier, avec vérins réglables.
- > Stehtisch mit Gestell aus Stahlrohren und Verstellgleitern.
- > Pie de mesa en acero, con pies niveladores. Mesa alta.

Piani Tavolo / Table Tops /
Plateaux De Table / Tischplatten /
Sobres De Mesa
Ø 60 cm
Ø 70 cm
60x60 cm



467

- > Tavolo con telaio in tubo acciaio, piedini regolabili.
- > Table frame in painted steel, with adjustable feet.
- > Pied de table en acier, avec vérins réglables.
- > Tisch mit Gestell aus Stahlrohren und Verstellgleitern.
- > Pie de mesa en acero, con pies niveladores.

Piani Tavolo / Table Tops /
Plateaux De Table / Tischplatten /
Sobres De Mesa
Ø 80 cm
Ø 90 cm
Ø 100 cm
80x80 cm
90x90 cm



467A

- > Tavolo alto con telaio in tubo acciaio, piedini regolabili.
- > High table frame in painted steel, with adjustable feet.
- > Pied mange debout en acier, avec vérins réglables.
- > Stehtisch mit Gestell aus Stahlrohren und Verstellgleitern.
- > Pie de mesa en acero, con pies niveladores. Mesa alta.

Piani Tavolo / Table Tops /
Plateaux De Table / Tischplatten /
Sobres De Mesa
Ø 80 cm
Ø 90 cm
70x70 cm
80x80 cm
90x90 cm

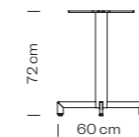

Peso / Weight /
Poids / Gewicht / Peso **5 kg**

Imballo / Packaging /
Emballage / Verpackung /
Embalaje **0,08 m³**

Pezzi per scatola /
Pieces per box /
Pièces par carton /
Stücke in einem Karton /
Piezas por caja **2**

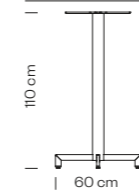

Peso / Weight /
Poids / Gewicht / Peso **6,3 kg**

Imballo / Packaging /
Emballage / Verpackung /
Embalaje **0,09 m³**

Pezzi per scatola /
Pieces per box /
Pièces par carton /
Stücke in einem Karton /
Piezas por caja **1**

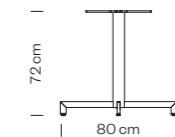

Peso / Weight /
Poids / Gewicht / Peso **5,5 kg**

Imballo / Packaging /
Emballage / Verpackung /
Embalaje **0,08 m³**

Pezzi per scatola /
Pieces per box /
Pièces par carton /
Stücke in einem Karton /
Piezas por caja **2**

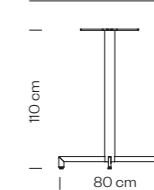

Peso / Weight /
Poids / Gewicht / Peso **6,8 kg**

Imballo / Packaging /
Emballage / Verpackung /
Embalaje **0,09 m³**

Pezzi per scatola /
Pieces per box /
Pièces par carton /
Stücke in einem Karton /
Piezas por caja **1**

317



468

- > Tavolo con telaio in tubo acciaio, piedini regolabili.
- > Table frame in painted steel, with adjustable feet.
- > Pied de table en acier, avec vérins réglables.
- > Tisch mit Gestell aus Stahlrohren und Verstellgleitern.
- > Pie de mesa en acero, con pies niveladores.

Piani Tavolo / Table Tops /
Plateaux De Table / Tischplatten /
Sobres De Mesa
Ø 100 cm
Ø 110 cm
Ø 120 cm
Ø 130 cm
100x100 cm
110x110 cm
120x120 cm

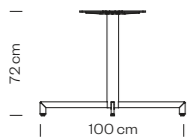

Peso / Weight /
Poids / Gewicht / Peso **8 kg**

Imballo / Packaging /
Emballage / Verpackung /
Embalaje **0,12 m³**

Pezzi per scatola /
Pieces per box /
Pièces par carton /
Stücke in einem Karton /
Piezas por caja **2**



469

- > Tavolo con telaio in tubo acciaio, piedini regolabili.
- > Table frame in painted steel, with adjustable feet.
- > Pied de table en acier, avec vérins réglables.
- > Tisch mit Gestell aus Stahlrohren und Verstellgleitern.
- > Pie de mesa en acero, con pies niveladores.

Piani Tavolo / Table Tops /
Plateaux De Table / Tischplatten /
Sobres De Mesa
70x110 cm
80x120 cm
90x130 cm

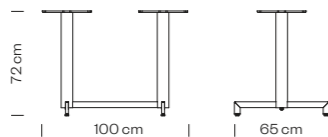

Peso / Weight /
Poids / Gewicht / Peso **8 kg**

Imballo / Packaging /
Emballage / Verpackung /
Embalaje **0,12 m³**

Pezzi per scatola /
Pieces per box /
Pièces par carton /
Stücke in einem Karton /
Piezas por caja **2**

AC

- > Finiture telaio (vedi p. 395)
- > Frame finishes (see p. 395)
- > Finitions piètement (voir p. 395)
- > Gestell fertigungen (sehen S. 395)
- > Acabados estructura (ver p. 395)



zenith

design
rdm, 2012



320



472Q

- > Tavolo con telaio in tubo acciaio verniciato. Piedini regolabili.
- > Table frame in painted steel, with adjustable feet.
- > Pied de table en acier verni, avec verins réglables.
- > Tisch mit Gestell aus lackierten Stahlrohren und Verstellgleitern.
- > Pie de mesa en acero barnizado, con pies niveladores.

Piani Tavolo / Table Tops /
Plateaux De Table / Tischplatten /
Sobres De Mesa
69x69 cm
80x80 cm



472R

- > Tavolo con telaio in tubo acciaio verniciato. Piedini regolabili.
- > Table frame in painted steel, with adjustable feet.
- > Pied de table en acier verni, avec verins réglables.
- > Tisch mit Gestell aus lackierten Stahlrohren und Verstellgleitern.
- > Pie de mesa en acero barnizado, con pies niveladores.

Piani Tavolo / Table Tops /
Plateaux De Table / Tischplatten /
Sobres De Mesa
69x119 cm
80x130 cm
90x130 cm

AC

- > Finiture telaio (vedi p. 395)
- > Frame finishes (see p. 395)
- > Finitions piètement (voir p. 395)
- > Gestell fertigungen (sehen S. 395)
- > Acabados estructura (ver p. 395)

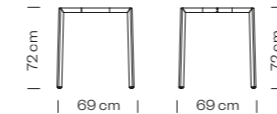

Peso / Weight /
Poids / Gewicht / Peso **6 kg**

Imballo / Packaging /
Emballage / Verpackung /
Embalaje **0,30 m³**

Pezzi per scatola /
Pieces per box /
Pièces par carton /
Stücke in einem Karton /
Piezas por caja **5**

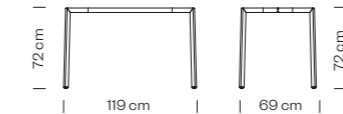

Peso / Weight /
Poids / Gewicht / Peso **6,5 kg**

Imballo / Packaging /
Emballage / Verpackung /
Embalaje **0,30 m³**

Pezzi per scatola /
Pieces per box /
Pièces par carton /
Stücke in einem Karton /
Piezas por caja **5**

321

mt

design
rdm, 2006



481

- > Tavolo con basamento in lamiera acciaio verniciata, colonna in tubo acciaio o faggio.
- > Table frame in painted steel sheet, steel or beech wood column.
- > Pied de table en acier verni, avec colonne en acier ou en hêtre.
- > Tischgestell mit lackierter Bodenplatte aus Stahl, Säule aus Stahlrohr oder Buchenrohr.
- > Pie de mesa con base en plancha de acero barnizada, columna en acero o en madera de haya.

Piani Tavolo / Table Tops /
Plateaux De Table / Tischplatten /
Sobres De Mesa
Ø 60 cm
Ø 70 cm
60x60 cm
70x70 cm

481A

- > Tavolo alto con basamento in lamiera acciaio verniciata, colonna in tubo acciaio o faggio.
- > High table frame in painted steel sheet, steel or beech wood column.
- > Pied mange debout en acier verni, avec colonne en acier ou en hêtre.
- > Stehtischgestell mit lackierter Bodenplatte aus Stahl, Säule aus Stahlrohr oder Buchenrohr.
- > Pie de mesa con base en plancha de acero barnizada, columna en acero o en madera de haya. Mesa alta.

Piani Tavolo / Table Tops /
Plateaux De Table / Tischplatten /
Sobres De Mesa
Ø 60 cm
Ø 70 cm
60x60 cm

481A F

- > Tavolo alto con basamento in lamiera acciaio verniciata, colonna in tubo acciaio. Fissaggio a terra.
- > High table frame in painted steel sheet and steel column. Floor fixing.
- > Pied mange debout en acier verni, avec colonne en acier, pour fixation au sol.
- > Stehtischgestell mit lackierter Bodenplatte aus Stahl, Säule aus Stahlrohr oder Buchenrohr. Bodemontage.
- > Pie de mesa con base en plancha de acero barnizada para fijar al suelo, columna en acero. Mesa alta.

Piani Tavolo / Table Tops /
Plateaux De Table / Tischplatten /
Sobres De Mesa
Ø 60 cm
Ø 70 cm
60x60 cm
70x70 cm

481F

- > Tavolo con basamento in lamiera acciaio verniciata, colonna in tubo acciaio. Fissaggio a terra.
- > Table frame in painted steel sheet and steel column. Floor fixing.
- > Pied de table en acier verni, avec colonne en acier, pour fixation au sol.
- > Tischgestell mit lackierter Bodenplatte aus Stahl, Säule aus Stahlrohr. Bodemontage.
- > Pie de mesa con base en plancha de acero barnizada para fijar al suelo, columna en acero.

Piani Tavolo / Table Tops /
Plateaux De Table / Tischplatten /
Sobres De Mesa
Ø 60 cm
Ø 70 cm
60x60 cm
70x70 cm



Peso / Weight /
Poids / Gewicht / Peso **11,1 kg**

Imballo / Packaging /
Emballage / Verpackung /
Embalaje **0,06 m³**

Pezzi per scatola /
Pieces per box /
Pièces par carton /
Stücke in einem Karton /
Piezas por caja **2**



Peso / Weight /
Poids / Gewicht / Peso **12,3 kg**

Imballo / Packaging /
Emballage / Verpackung /
Embalaje **0,06 m³**

Pezzi per scatola /
Pieces per box /
Pièces par carton /
Stücke in einem Karton /
Piezas por caja **2**

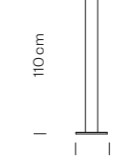

Peso / Weight /
Poids / Gewicht / Peso **9,8 kg**

Imballo / Packaging /
Emballage / Verpackung /
Embalaje **0,06 m³**

Pezzi per scatola /
Pieces per box /
Pièces par carton /
Stücke in einem Karton /
Piezas por caja **2**

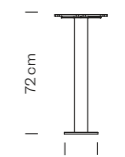

Peso / Weight /
Poids / Gewicht / Peso **8,5 kg**

Imballo / Packaging /
Emballage / Verpackung /
Embalaje **0,06 m³**

Pezzi per scatola /
Pieces per box /
Pièces par carton /
Stücke in einem Karton /
Piezas por caja **2**



482

- > Tavolo con basamento in lamiera acciaio verniciata, colonna in tubo acciaio o faggio.
- > Table frame in painted steel sheet. Steel or beech wood column.
- > Pied de table en acier verni, avec colonne en acier ou en hêtre.
- > Tischgestell mit lackierter Bodenplatte aus Stahl, Säule aus Stahlrohr oder Buchenrohr.
- > Pie de mesa con base en plancha de acero barnizada, columna en acero o en madera de haya.

Piani Tavolo / Table Tops / Plateaux De Table / Tischplatten / Sobres De Mesa
 Ø 80 cm
 Ø 90 cm
 80x80 cm
 90x90 cm



482A

- > Tavolo alto con basamento in lamiera acciaio verniciata, colonna in tubo acciaio o faggio.
- > High table frame in painted steel sheet, steel or beech wood column.
- > Pied mange debout en acier verni, avec colonne en acier ou en hêtre.
- > Stehtischgestell mit lackierter Bodenplatte aus Stahl, Säule aus Stahlrohr oder Buchenrohr.
- > Pie de mesa con base en plancha de acero barnizada, columna en acero o en madera de haya. Mesa alta.

Piani Tavolo / Table Tops / Plateaux De Table / Tischplatten / Sobres De Mesa
 Ø 80 cm
 Ø 90 cm
 70x70 cm



483

- > Tavolo con basamento in lamiera acciaio verniciata, colonna in tubo acciaio o faggio.
- > Table frame in painted steel sheet, steel or beech wood column.
- > Pied de table en acier verni, avec colonne en acier ou en hêtre.
- > Tischgestell mit lackierter Bodenplatte aus Stahl, Säule aus Stahlrohr oder Buchenrohr.
- > Pie de mesa con base en plancha de acero barnizada, columna en acero o en madera de haya.

Piani Tavolo / Table Tops / Plateaux De Table / Tischplatten / Sobres De Mesa
 Ø 60 cm
 Ø 70 cm
 60x60 cm
 70x70 cm



483A

- > Tavolo alto con basamento in lamiera acciaio verniciata, colonna in tubo acciaio.
- > High table frame in painted steel sheet, steel or beech wood column.
- > Pied mange debout en acier verni, avec colonne en acier.
- > Stehtischgestell mit lackierter Bodenplatte aus Stahl, Säule aus Stahlrohr.
- > Pie de mesa con base en plancha de acero barnizada, columna en acero. Mesa alta.

Piani Tavolo / Table Tops / Plateaux De Table / Tischplatten / Sobres De Mesa
 Ø 60 cm
 Ø 70 cm
 60x60 cm



484

- > Tavolo con basamento in lamiera acciaio verniciata, colonna in tubo acciaio o faggio.
- > Table frame in painted steel. Available with steel or beech wood column.
- > Pied de table en acier verni, avec colonne en acier ou en hêtre.
- > Tischgestell mit lackierter Bodenplatte aus Stahl, Säule aus Stahlrohr oder Buchenrohr.
- > Pie de mesa con base en plancha de acero barnizada, columna en acero o en madera de haya.

Piani Tavolo / Table Tops / Plateaux De Table / Tischplatten / Sobres De Mesa
 Ø 80 cm
 Ø 90 cm
 80x80 cm
 90x90 cm



484A

- > Tavolo alto con basamento in lamiera acciaio verniciata, colonna in tubo acciaio.
- > High table frame in painted steel sheet, steel column.
- > Pied mange debout en acier verni, avec colonne en acier.
- > Stehtischgestell mit lackierter Bodenplatte aus Stahl, Säule aus Stahlrohr.
- > Pie de mesa con base en plancha de acero barnizada, columna en acero. Mesa alta.

Piani Tavolo / Table Tops / Plateaux De Table / Tischplatten / Sobres De Mesa
 Ø 80 cm
 Ø 90 cm
 70x70 cm
 80x80 cm



491Q

- > Tavolo con basamento in lamiera acciaio verniciata, colonna in tubo acciaio o faggio.
- > Table frame in painted steel sheet, steel or beech wood column.
- > Pied de table en acier verni, avec colonne en acier ou en hêtre.
- > Tischgestell mit lackierter Bodenplatte aus Stahl, Säule aus Stahlrohr oder Buchenrohr.
- > Pie de mesa con base en plancha de acero barnizada, columna en acero o en madera de haya.

Piani Tavolo / Table Tops / Plateaux De Table / Tischplatten / Sobres De Mesa
 70x120 cm
 70x130 cm
 70x140 cm
 80x120 cm
 80x130 cm
 80x140 cm



491T

- > Tavolo con basamento in lamiera acciaio verniciata, colonna in tubo acciaio o faggio.
- > Table frame in painted steel sheet, steel or beech wood column.
- > Pied de table en acier verni, avec colonne en acier ou en hêtre.
- > Tischgestell mit lackierter Bodenplatte aus Stahl, Säule aus Stahlrohr oder Buchenrohr.
- > Pie de mesa con base en plancha de acero barnizada, columna en acero o en madera de haya.

Piani Tavolo / Table Tops / Plateaux De Table / Tischplatten / Sobres De Mesa
 70x120 cm
 70x130 cm
 70x140 cm
 80x120 cm
 80x130 cm
 80x140 cm



Peso / Weight / Poids / Gewicht / Peso **14,1 kg**

Imballo / Packaging / Emballage / Verpackung / Embalaje **0,06 m³**

Pezzi per scatola / Pieces per box / Pièces par carton / Stücke in einem Karton / Piezas por caja **2**

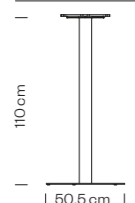

Peso / Weight / Poids / Gewicht / Peso **15,3 kg**

Imballo / Packaging / Emballage / Verpackung / Embalaje **0,06 m³**

Pezzi per scatola / Pieces per box / Pièces par carton / Stücke in einem Karton / Piezas por caja **2**



Peso / Weight / Poids / Gewicht / Peso **13,6 kg**

Imballo / Packaging / Emballage / Verpackung / Embalaje **0,06 m³**

Pezzi per scatola / Pieces per box / Pièces par carton / Stücke in einem Karton / Piezas por caja **2**

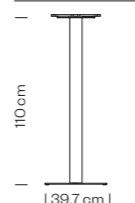

Peso / Weight / Poids / Gewicht / Peso **15,1 kg**

Imballo / Packaging / Emballage / Verpackung / Embalaje **0,06 m³**

Pezzi per scatola / Pieces per box / Pièces par carton / Stücke in einem Karton / Piezas por caja **2**

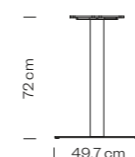

Peso / Weight / Poids / Gewicht / Peso **17,9 kg**

Imballo / Packaging / Emballage / Verpackung / Embalaje **0,07 m³**

Pezzi per scatola / Pieces per box / Pièces par carton / Stücke in einem Karton / Piezas por caja **2**

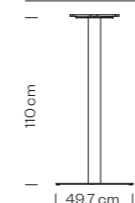

Peso / Weight / Poids / Gewicht / Peso **19,4 kg**

Imballo / Packaging / Emballage / Verpackung / Embalaje **0,07 m³**

Pezzi per scatola / Pieces per box / Pièces par carton / Stücke in einem Karton / Piezas por caja **2**

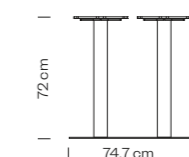

Peso / Weight / Poids / Gewicht / Peso **26,2 kg**

Imballo / Packaging / Emballage / Verpackung / Embalaje **0,06 m³**

Pezzi per scatola / Pieces per box / Pièces par carton / Stücke in einem Karton / Piezas por caja **1**

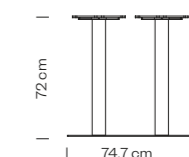

Peso / Weight / Poids / Gewicht / Peso **22,5 kg**

Imballo / Packaging / Emballage / Verpackung / Embalaje **0,06 m³**

Pezzi per scatola / Pieces per box / Pièces par carton / Stücke in einem Karton / Piezas por caja **1**



491A Q

- > Tavolo alto con basamento in lamiera acciaio verniciata, colonna in tubo acciaio.
- > High table frame in painted steel sheet, steel or beech wood column.
- > Pied mange debout en acier verni, avec colonne en acier.
- > Stehtischgestell mit lackierter Bodenplatte aus Stahl, Säule aus Stahlrohr.
- > Pie de mesa con base en plancha de acero barnizada, columna en acero. Mesa alta.

Piani Tavolo / Table Tops / Plateaux De Table / Tischplatten / Sobres De Mesa
 70x120 cm
 70x130 cm
 80x120 cm
 80x130 cm



491A T

- > Tavolo alto con basamento in lamiera acciaio verniciata, colonna in tubo acciaio o faggio.
- > High table frame in painted steel sheet, steel or beech wood column.
- > Pied mange debout en acier verni, avec colonne en acier ou en hêtre.
- > Stehtischgestell mit lackierter Bodenplatte aus Stahl, Säule aus Stahlrohr oder Buchenrohr.
- > Pie de mesa con base en plancha de acero barnizada, columna en madera de haya. Mesa alta.

Piani Tavolo / Table Tops / Plateaux De Table / Tischplatten / Sobres De Mesa
 70x120 cm
 70x130 cm
 80x120 cm
 80x130 cm



493

- > Tavolo con basamento in lamiera acciaio verniciata, colonna in tubo acciaio o faggio.
- > Table frame in painted steel sheet, steel or beech wood column.
- > Pied de table en acier verni, avec colonne en acier ou en hêtre.
- > Tischgestell mit lackierter Bodenplatte aus Stahl, Säule aus Stahlrohr oder Buchenrohr.
- > Pie de mesa con base en plancha de acero barnizada, columna en acero o en madera de haya.

Piani Tavolo / Table Tops / Plateaux De Table / Tischplatten / Sobres De Mesa
 Ø 110 cm
 Ø 120 cm
 Ø 130 cm
 100x100 cm
 110x110 cm



497

- > Tavolo con basamento in lamiera acciaio verniciata, colonna in tubo acciaio.
- > Table frame in painted steel sheet, steel column.
- > Pied de table avec embase et colonne en acier verni.
- > Tischgestell mit lackierter Bodenplatte aus Stahl, Säule aus Stahlrohr.
- > Pie de mesa con base en plancha de acero barnizada, columna en acero.

Piani Tavolo / Table Tops / Plateaux De Table / Tischplatten / Sobres De Mesa
 Ø 60 cm
 Ø 70 cm
 60x60 cm



497A

- > Tavolo alto con basamento in lamiera acciaio verniciata, colonna in tubo acciaio.
- > High table frame in painted steel sheet, steel column.
- > Pied mange debout avec embase et colonne en acier verni.
- > Stehtischgestell mit lackierter Bodenplatte aus Stahl, Säule aus Stahlrohr.
- > Pie de mesa con base en plancha de acero barnizada, columna en acero. Mesa alta.

Piani Tavolo / Table Tops / Plateaux De Table / Tischplatten / Sobres De Mesa
 Ø 60 cm
 Ø 70 cm
 60x60 cm



498Q

- > Tavolo con basamento in lamiera acciaio verniciata, colonna in tubo acciaio.
- > Table frame in painted steel sheet, steel column.
- > Pied de table avec embase et colonne en acier verni.
- > Tischgestell mit lackierter Bodenplatte aus Stahl, Säule aus Stahlrohr.
- > Pie de mesa con base en plancha de acero barnizada, columna en acero.

Piani Tavolo / Table Tops / Plateaux De Table / Tischplatten / Sobres De Mesa
 Ø 60 cm
 Ø 70 cm
 60x60 cm
 70x70 cm



498T

- > Tavolo con basamento in lamiera acciaio verniciata, colonna in tubo acciaio.
- > Table frame in painted steel sheet, steel column.
- > Pied de table avec embase et colonne en acier verni.
- > Tischgestell mit lackierter Bodenplatte aus Stahl, Säule aus Stahlrohr.
- > Pie de mesa con base en plancha de acero barnizada, columna en acero.

Piani Tavolo / Table Tops / Plateaux De Table / Tischplatten / Sobres De Mesa
 Ø 60 cm
 Ø 70 cm
 60x60 cm
 70x70 cm



498A Q

- > Tavolo alto con basamento in lamiera acciaio verniciata, colonna in tubo acciaio.
- > High table frame in painted steel sheet, steel column.
- > Pied mange debout avec embase et colonne en acier verni.
- > Stehtischgestell mit lackierter Bodenplatte aus Stahl, Säule aus Stahlrohr.
- > Pie de mesa con base en plancha de acero barnizada, columna en acero. Mesa alta.

Piani Tavolo / Table Tops / Plateaux De Table / Tischplatten / Sobres De Mesa
 Ø 60 cm
 Ø 70 cm
 60x60 cm

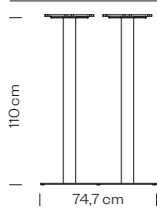

Peso / Weight / Poids / Gewicht / Peso **29,2 kg**

Imballo / Packaging / Emballage / Verpackung / Embalaje **0,06 m³**

Pezzi per scatola / Pieces per box / Pièces par carton / Stücke in einem Karton / Piezas por caja **1**

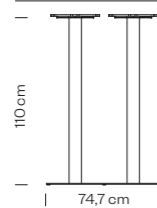

Peso / Weight / Poids / Gewicht / Peso **25,2 kg**

Imballo / Packaging / Emballage / Verpackung / Embalaje **0,06 m³**

Pezzi per scatola / Pieces per box / Pièces par carton / Stücke in einem Karton / Piezas por caja **1**

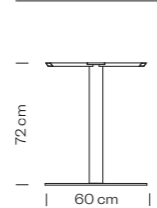

Peso / Weight / Poids / Gewicht / Peso **28 kg**

Imballo / Packaging / Emballage / Verpackung / Embalaje **0,06 m³**

Pezzi per scatola / Pieces per box / Pièces par carton / Stücke in einem Karton / Piezas por caja **1**

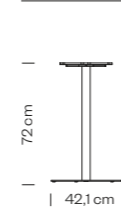

Peso / Weight / Poids / Gewicht / Peso **10,7 kg**

Imballo / Packaging / Emballage / Verpackung / Embalaje **0,06 m³**

Pezzi per scatola / Pieces per box / Pièces par carton / Stücke in einem Karton / Piezas por caja **2**

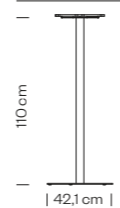

Peso / Weight / Poids / Gewicht / Peso **11,4 kg**

Imballo / Packaging / Emballage / Verpackung / Embalaje **0,06 m³**

Pezzi per scatola / Pieces per box / Pièces par carton / Stücke in einem Karton / Piezas por caja **2**

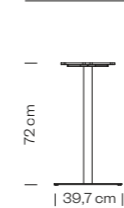

Peso / Weight / Poids / Gewicht / Peso **11,9 kg**

Imballo / Packaging / Emballage / Verpackung / Embalaje **0,06 m³**

Pezzi per scatola / Pieces per box / Pièces par carton / Stücke in einem Karton / Piezas por caja **2**

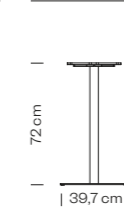

Peso / Weight / Poids / Gewicht / Peso **11,9 kg**

Imballo / Packaging / Emballage / Verpackung / Embalaje **0,06 m³**

Pezzi per scatola / Pieces per box / Pièces par carton / Stücke in einem Karton / Piezas por caja **2**

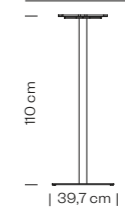

Peso / Weight / Poids / Gewicht / Peso **12,9 kg**

Imballo / Packaging / Emballage / Verpackung / Embalaje **0,06 m³**

Pezzi per scatola / Pieces per box / Pièces par carton / Stücke in einem Karton / Piezas por caja **2**



498A T

- > Tavolo alto con basamento in lamiera acciaio verniciata, colonna in tubo acciaio.
- > High table frame in painted steel sheet, steel column.
- > Pied mange debout avec embase et colonne en acier verni.
- > Stehtischgestell mit lackierter Bodenplatte aus Stahl, Säule aus Stahlrohr.
- > Pie de mesa con base en plancha de acero barnizada, columna en acero. Mesa alta.

Piani Tavolo / Table Tops /
Plateaux De Table / Tischplatten /
Sobres De Mesa
Ø 60 cm
Ø 70 cm
60x60 cm

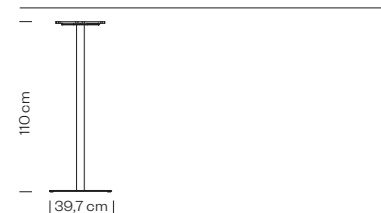

Peso / Weight /
Poids / Gewicht / Peso **12,3 kg**

Imballo / Packaging /
Emballage / Verpackung /
Embalaje **0,06 m³**

Pezzi per scatola /
Pieces per box /
Pièces par carton /
Stücke in einem Karton /
Piezas por caja **2**



499Q

- > Tavolo con basamento in lamiera acciaio verniciata, colonna in tubo acciaio.
- > Table frame in painted steel sheet, steel column.
- > Pied de table avec embase et colonne en acier verni.
- > Tischgestell mit lackierter Bodenplatte aus Stahl, Säule aus Stahlrohr.
- > Pie de mesa con base en plancha de acero barnizada, columna en acero.

Piani Tavolo / Table Tops /
Plateaux De Table / Tischplatten /
Sobres De Mesa
70x120 cm
70x130 cm
80x120 cm
80x130 cm

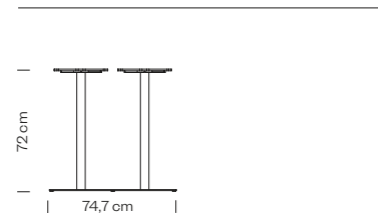

Peso / Weight /
Poids / Gewicht / Peso **21,7 kg**

Imballo / Packaging /
Emballage / Verpackung /
Embalaje **0,06 m³**

Pezzi per scatola /
Pieces per box /
Pièces par carton /
Stücke in einem Karton /
Piezas por caja **1**



499T

- > Tavolo con basamento in lamiera acciaio verniciata, colonna in tubo acciaio.
- > Table frame in painted steel sheet, steel column.
- > Pied de table avec embase et colonne en acier verni.
- > Tischgestell mit lackierter Bodenplatte aus Stahl, Säule aus Stahlrohr.
- > Pie de mesa con base en plancha de acero barnizada, columna en acero.

Piani Tavolo / Table Tops /
Plateaux De Table / Tischplatten /
Sobres De Mesa
70x120 cm
70x130 cm
80x120 cm
80x130 cm

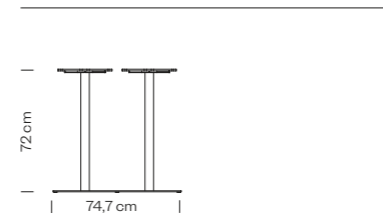

Peso / Weight /
Poids / Gewicht / Peso **21 kg**

Imballo / Packaging /
Emballage / Verpackung /
Embalaje **0,06 m³**

Pezzi per scatola /
Pieces per box /
Pièces par carton /
Stücke in einem Karton /
Piezas por caja **1**



499A Q

- > Tavolo alto con basamento in lamiera acciaio verniciata, colonna in tubo acciaio.
- > High table frame in painted steel sheet, steel column.
- > Pied mange debout avec embase et colonne en acier verni.
- > Stehtischgestell mit lackierter Bodenplatte aus Stahl, Säule aus Stahlrohr.
- > Pie de mesa con base en plancha de acero barnizada, columna en acero. Mesa alta.

Piani Tavolo / Table Tops /
Plateaux De Table / Tischplatten /
Sobres De Mesa
70x120 cm
70x130 cm
80x120 cm
80x130 cm

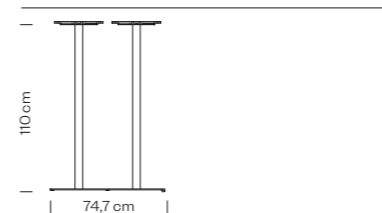

Peso / Weight /
Poids / Gewicht / Peso **23,5 kg**

Imballo / Packaging /
Emballage / Verpackung /
Embalaje **0,06 m³**

Pezzi per scatola /
Pieces per box /
Pièces par carton /
Stücke in einem Karton /
Piezas por caja **1**



499A T

- > Tavolo alto con basamento in lamiera acciaio verniciata, colonna in tubo acciaio.
- > High table frame in painted steel sheet, steel column.
- > Pied mange debout avec embase et colonne en acier verni.
- > Stehtischgestell mit lackierter Bodenplatte aus Stahl, Säule aus Stahlrohr.
- > Pie de mesa con base en plancha de acero barnizada, columna en acero. Mesa alta.

Piani Tavolo / Table Tops /
Plateaux De Table / Tischplatten /
Sobres De Mesa
70x120 cm
70x130 cm
80x120 cm
80x130 cm

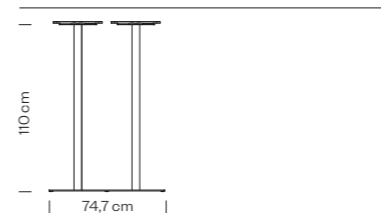

Peso / Weight /
Poids / Gewicht / Peso **22,4 kg**

Imballo / Packaging /
Emballage / Verpackung /
Embalaje **0,06 m³**

Pezzi per scatola /
Pieces per box /
Pièces par carton /
Stücke in einem Karton /
Piezas por caja **1**

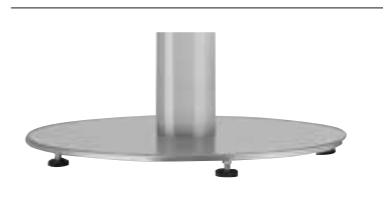

**Accessori / Accessories /
Accessoires / Zubehoer /
Accessorios**

Piedini Regolabili H 12 mm /
H 12 mm adjustable feet /
Vérins réglables H 12 mm /
Verstellgleitern H. 12 mm /
Pies niveladores H 12 mm

AC

- > Finiture telaio (vedi p. 395)
- > Frame finishes (see p. 395)
- > Finitions piètement (voir p. 395)
- > Gestell fertigungen (sehen S. 395)
- > Acabados estructura (ver p. 395)

LE

- > Finiture telaio
- > Frame finishes
- > Finitions piètement
- > Gestell fertigungen
- > Acabados estructura

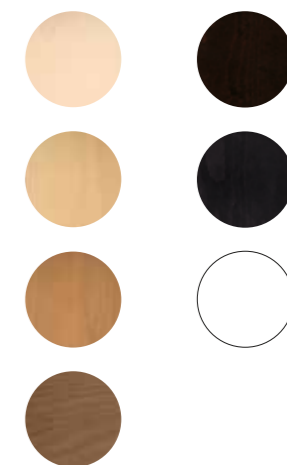

xt

design
rdm, 2005



477

- > Tavolo con copri-base in acciaio inox lucido o satinato, colonna in acciaio inox lucido o satinato, o faggio.
- > Table frame with base cover in glossy or satin stainless steel. Glossy or satin stainless steel, or beech wood column.
- > Pied de table avec capot pour embase en inox finition brillant ou satiné, colonne en inox finition brillant ou satiné, ou en hêtre.
- > Tisch mit Bodenplatte aus poliertem oder Matt Edelstahl, Säule aus poliertem oder Matt Edelstahl oder Buchenholz.
- > Pie de mesa con capa de la base en acero inox pulido o satinado, columna en acero inox pulido o satinado o en madera de haya.

Piani Tavolo / Table Tops /
Plateaux De Table / Tischplatten /
Sobres De Mesa
Ø 60 cm
Ø 70 cm
60x60 cm
70x70 cm

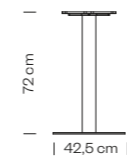

Peso / Weight /
Poids / Gewicht / Peso **12,5 kg**

Imballo / Packaging /
Emballage / Verpackung /
Embalaje **0,06 m³**

Pezzi per scatola /
Pieces per box /
Pièces par carton /
Stücke in einem Karton /
Piezas por caja **2**

477A F

- > Tavolo alto con copri-base in acciaio inox lucido o satinato, colonna in acciaio inox lucido o satinato. Fissaggio a terra.
- > High table frame with base cover in glossy or satin stainless steel, column in glossy or satin stainless steel. Floor fixing.
- > Pied mange debout avec capot pour embase en inox finition brillant ou satiné, colonne en inox finition brillant ou satiné. Pour fixation au sol.
- > Stehtisch mit Bodenplatte aus poliertem oder Matt Edelstahl, Säule aus poliertem oder Matt Edelstahl. Bodemontage.
- > Pie de mesa con capa de la base en acero inox pulido o satinado para fijar al suelo, columna en acero inox pulido o satinado. Mesa alta.

Piani Tavolo / Table Tops /
Plateaux De Table / Tischplatten /
Sobres De Mesa
Ø 60 cm
Ø 70 cm
60x60 cm
70x70 cm

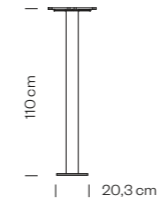

Peso / Weight /
Poids / Gewicht / Peso **9,8 kg**

Imballo / Packaging /
Emballage / Verpackung /
Embalaje **0,06 m³**

Pezzi per scatola /
Pieces per box /
Pièces par carton /
Stücke in einem Karton /
Piezas por caja **2**

477F

- > Tavolo con copri-base in acciaio inox lucido o satinato, colonna in acciaio inox lucido o satinato. Fissaggio a terra.
- > Table frame with base cover in glossy or satin stainless steel, column in glossy or satin stainless steel. Floor fixing.
- > Pied de table avec capot pour embase en inox finition brillant ou satiné, colonne en inox finition brillant ou satiné. Pour fixation au sol.
- > Tisch mit Bodenplatte aus poliertem oder Matt Edelstahl, Säule aus poliertem oder Matt Edelstahl. Bodemontage.
- > Pie de mesa con capa de la base en acero inox pulido o satinado para fijar al suelo, columna en acero inox pulido o satinado.

Piani Tavolo / Table Tops /
Plateaux De Table / Tischplatten /
Sobres De Mesa
Ø 60 cm
Ø 70 cm
60x60 cm
70x70 cm

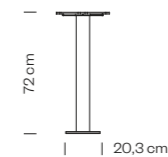

Peso / Weight /
Poids / Gewicht / Peso **8,5 kg**

Imballo / Packaging /
Emballage / Verpackung /
Embalaje **0,06 m³**

Pezzi per scatola /
Pieces per box /
Pièces par carton /
Stücke in einem Karton /
Piezas por caja **2**

477A

- > Tavolo alto con copri-base in acciaio inox lucido o satinato, colonna in acciaio inox lucido o satinato, o faggio.
- > High table frame with base cover in glossy or satin stainless steel. Glossy or satin stainless steel, or beech wood column.
- > Pied mange debout avec capot pour embase en inox finition brillant ou satiné, colonne en inox finition brillant ou satiné, ou en hêtre.
- > Stehtisch mit Bodenplatte aus poliertem oder Matt Edelstahl, Säule aus poliertem oder Matt Edelstahl oder Buchenholz.
- > Pie de mesa con capa de la base en acero inox pulido o satinado, columna en acero inox pulido o satinado o en madera de haya. Mesa alta.

Piani Tavolo / Table Tops /
Plateaux De Table / Tischplatten /
Sobres De Mesa
Ø 60 cm
Ø 70 cm
60x60 cm
70x70 cm

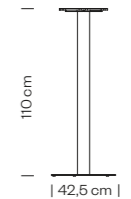

Peso / Weight /
Poids / Gewicht / Peso **12,5 kg**

Imballo / Packaging /
Emballage / Verpackung /
Embalaje **0,06 m³**

Pezzi per scatola /
Pieces per box /
Pièces par carton /
Stücke in einem Karton /
Piezas por caja **2**



477B

- > Tavolo basso con copri-base in acciaio inox lucido o satinato, colonna in acciaio inox lucido o satinato.
- > Low table frame with base cover in glossy or satin stainless steel. Glossy or satin stainless steel column.
- > Pied de table avec capot pour embase en inox finition brillant ou satiné, colonne en inox finition brillant ou satiné. Version hauteur 42,5 cm.
- > Niedriger Tisch mit Bodenplatte aus poliertem oder Matt Edelstahl, Säule aus poliertem oder Matt Edelstahl.
- > Pie de mesa con capa de la base en acero inox pulido o satinado, columna en acero inox pulido o satinado. Mesa baja.

Piani Tavolo / Table Tops / Plateaux De Table / Tischplatten / Sobres De Mesa
 Ø 80 cm
 Ø 90 cm
 Ø 100 cm
 70x70 cm
 80x80 cm
 90x90 cm

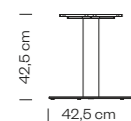

Peso / Weight / Poids / Gewicht / Peso **11,5 kg**

Imballo / Packaging / Emballage / Verpackung / Embalaje **0,05 m³**

Pezzi per scatola / Pieces per box / Pièces par carton / Stücke in einem Karton / Piezas por caja **2**



478

- > Tavolo con copri-base in acciaio inox lucido o satinato, colonna in acciaio inox lucido o satinato, o faggio.
- > Table frame with base cover in glossy or satin stainless steel. Glossy or satin stainless steel, or beech wood column.
- > Pied de table avec capot pour embase en inox finition brillant ou satiné, colonne en inox finition brillant ou satiné, ou en hêtre.
- > Tisch mit Bodenplatte aus poliertem oder Matt Edelstahl, Säule aus poliertem oder Matt Edelstahl oder Buchenholz.
- > Pie de mesa con capa de la base en acero inox pulido o satinado, columna en acero inox pulido o satinado o en madera de haya.

Piani Tavolo / Table Tops / Plateaux De Table / Tischplatten / Sobres De Mesa
 Ø 80 cm
 Ø 90 cm
 Ø 100 cm
 70x70 cm
 80x80 cm
 90x90 cm

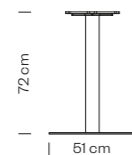

Peso / Weight / Poids / Gewicht / Peso **16,1 kg**

Imballo / Packaging / Emballage / Verpackung / Embalaje **0,05 m³**

Pezzi per scatola / Pieces per box / Pièces par carton / Stücke in einem Karton / Piezas por caja **1**



478A

- > Tavolo alto con copri-base in acciaio inox lucido o satinato, colonna in acciaio inox lucido o satinato, o faggio.
- > High table frame with base cover in glossy or satin stainless steel. Glossy or satin stainless steel, or beech wood column.
- > Pied mange debout avec capot pour embase en inox finition brillant ou satiné, colonne en inox finition brillant ou satiné, ou en hêtre.
- > Stehtisch mit Bodenplatte aus poliertem oder Matt Edelstahl, Säule aus poliertem oder Matt Edelstahl oder Buchenholz.
- > Pie de mesa con capa de la base en acero inox pulido o satinado, columna en acero inox pulido o satinado o en madera de haya. Mesa alta.

Piani Tavolo / Table Tops / Plateaux De Table / Tischplatten / Sobres De Mesa
 Ø 80 cm
 Ø 90 cm
 Ø 100 cm
 70x70 cm
 80x80 cm

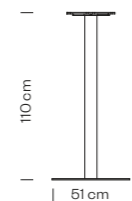

Peso / Weight / Poids / Gewicht / Peso **17,4 kg**

Imballo / Packaging / Emballage / Verpackung / Embalaje **0,05 m³**

Pezzi per scatola / Pieces per box / Pièces par carton / Stücke in einem Karton / Piezas por caja **2**



478B

- > Tavolo basso con copri-base in acciaio inox lucido o satinato, colonna in acciaio inox lucido o satinato.
- > Low table frame with base cover in glossy or satin stainless steel. Glossy or satin stainless steel column.
- > Pied de table avec capot pour embase en inox finition brillant ou satiné, colonne en inox finition brillant ou satiné. Version hauteur 42,5 cm.
- > Niedriger Tisch mit Bodenplatte aus poliertem oder Matt Edelstahl, Säule aus poliertem oder Matt Edelstahl.
- > Pie de mesa con capa de la base en acero inox pulido o satinado, columna en acero inox pulido o satinado. Mesa baja.

Piani Tavolo / Table Tops / Plateaux De Table / Tischplatten / Sobres De Mesa
 Ø 80 cm
 Ø 90 cm
 Ø 90 cm
 70x70 cm
 80x80 cm

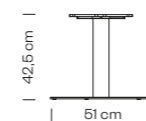

Peso / Weight / Poids / Gewicht / Peso **15,1 kg**

Imballo / Packaging / Emballage / Verpackung / Embalaje **0,05 m³**

Pezzi per scatola / Pieces per box / Pièces par carton / Stücke in einem Karton / Piezas por caja **1**



479Q

- > Tavolo con copri-base in acciaio inox lucido o satinato, colonna in acciaio inox lucido o satinato, o faggio.
- > Table frame with base cover in glossy or satin stainless steel. Glossy or satin stainless steel, or beech wood column.
- > Pied de table avec capot pour embase en inox finition brillant ou satiné, colonne en inox finition brillant ou satiné, ou en hêtre.
- > Tisch mit Bodenplatte aus poliertem oder Matt Edelstahl, Säule aus poliertem oder Matt Edelstahl oder Buchenholz.
- > Pie de mesa con capa de la base en acero inox pulido o satinado, columna en acero inox pulido o satinado o en madera de haya.

Piani Tavolo / Table Tops / Plateaux De Table / Tischplatten / Sobres De Mesa
 Ø 60 cm
 Ø 70 cm
 60x60 cm
 70x70 cm

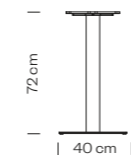

Peso / Weight / Poids / Gewicht / Peso **15 kg**

Imballo / Packaging / Emballage / Verpackung / Embalaje **0,06 m³**

Pezzi per scatola / Pieces per box / Pièces par carton / Stücke in einem Karton / Piezas por caja **2**



479T

- > Tavolo con copri-base in acciaio inox lucido o satinato, colonna in acciaio inox lucido o satinato, o faggio.
- > Table frame with base cover in glossy or satin stainless steel. Glossy or satin stainless steel, or beech wood column.
- > Pied de table avec capot pour embase en inox finition brillant ou satiné, colonne en inox finition brillant ou satiné, ou en hêtre.
- > Tisch mit Bodenplatte aus poliertem oder Matt Edelstahl, Säule aus poliertem oder Matt Edelstahl oder Buchenholz.
- > Pie de mesa con capa de la base en acero inox pulido o satinado, columna en acero inox pulido o satinado o en madera de haya.

Piani Tavolo / Table Tops / Plateaux De Table / Tischplatten / Sobres De Mesa
 Ø 60 cm
 Ø 70 cm
 60x60 cm
 70x70 cm

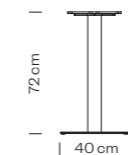

Peso / Weight / Poids / Gewicht / Peso **13,5 kg**

Imballo / Packaging / Emballage / Verpackung / Embalaje **0,06 m³**

Pezzi per scatola / Pieces per box / Pièces par carton / Stücke in einem Karton / Piezas por caja **2**



479A Q

- > Tavolo alto con copri-base in acciaio inox lucido o satinato, colonna in acciaio inox lucido o satinato, o faggio.
- > High table frame with base cover in glossy or satin stainless steel. Glossy or satin stainless steel column.
- > Pied mange debout avec capot pour embase en inox finition brillant ou satiné, colonne en inox finition brillant ou satiné.
- > Stehtisch mit Bodenplatte aus poliertem oder Matt Edelstahl, Säule aus poliertem oder Matt Edelstahl.
- > Pie de mesa con capa de la base en acero inox pulido o satinado, columna en acero inox pulido o satinado. Mesa alta.

Piani Tavolo / Table Tops / Plateaux De Table / Tischplatten / Sobres De Mesa
 Ø 60 cm
 Ø 70 cm
 60x60 cm

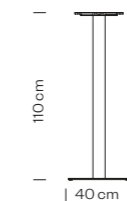

Peso / Weight / Poids / Gewicht / Peso **17 kg**

Imballo / Packaging / Emballage / Verpackung / Embalaje **0,06 m³**

Pezzi per scatola / Pieces per box / Pièces par carton / Stücke in einem Karton / Piezas por caja **2**



479A T

- > Tavolo alto con copri-base in acciaio inox lucido o satinato, colonna in acciaio inox lucido o satinato, o faggio.
- > High table frame with base cover in glossy or satin stainless steel. Glossy or satin stainless steel, or beech wood column.
- > Pied mange debout avec capot pour embase en inox finition brillant ou satiné, colonne en inox finition brillant ou satiné, ou en hêtre.
- > Stehtisch mit Bodenplatte aus poliertem oder Matt Edelstahl, Säule aus poliertem oder Matt Edelstahl oder Buchenholz.
- > Pie de mesa con capa de la base en acero inox pulido o satinado, columna en acero inox pulido o satinado o en madera de haya. Mesa alta.

Piani Tavolo / Table Tops / Plateaux De Table / Tischplatten / Sobres De Mesa
 Ø 60 cm
 Ø 70 cm
 60x60 cm

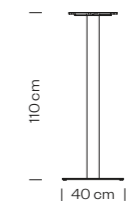

Peso / Weight / Poids / Gewicht / Peso **14,8 kg**

Imballo / Packaging / Emballage / Verpackung / Embalaje **0,06 m³**

Pezzi per scatola / Pieces per box / Pièces par carton / Stücke in einem Karton / Piezas por caja **2**



479B T

- > Tavolo basso con copri-base in acciaio inox lucido o satinato, colonna in acciaio inox lucido o satinato.
- > Low table frame with base cover in glossy or satin stainless steel. Glossy or satin stainless steel column.
- > Pied de table avec capot pour embase en inox finition brillant ou satiné, colonne en inox finition brillant ou satiné. Version hauteur 42,5 cm.
- > Niedriger Tisch mit Bodenplatte aus poliertem oder Matt Edelstahl, Säule aus poliertem oder Matt Edelstahl.
- > Pie de mesa con capa de la base en acero inox pulido o satinado, columna en acero inox pulido o satinado. Mesa baja.

Piani Tavolo / Table Tops / Plateaux De Table / Tischplatten / Sobres De Mesa
 Ø 60 cm
 Ø 70 cm
 60x60 cm
 70x70 cm



480Q

- > Tavolo con copri-base in acciaio inox lucido o satinato, colonna in acciaio inox lucido o satinato, o faggio.
- > Table frame with base cover in glossy or satin stainless steel. Glossy or satin stainless steel, or beech wood column.
- > Pied de table avec capot pour embase en inox finition brillant ou satiné, colonne en inox finition brillant ou satiné ou hêtre.
- > Tisch mit Bodenplatte aus poliertem oder Matt Edelstahl, Säule aus poliertem oder Matt Edelstahl oder Buchenholz.
- > Pie de mesa con capa de la base en acero inox pulido o satinado, columna en acero inox pulido o satinado o en madera de haya.

Piani Tavolo / Table Tops / Plateaux De Table / Tischplatten / Sobres De Mesa
 Ø 80 cm
 Ø 90 cm
 80x80 cm
 90x90 cm

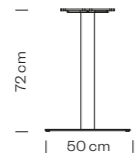

Peso / Weight / Poids / Gewicht / Peso **20 kg**

Imballo / Packaging / Emballage / Verpackung / Embalaje **0,05 m³**

Pezzi per scatola / Pieces per box / Pièces par carton / Stücke in einem Karton / Piezas por caja **1**



480T

- > Tavolo con copri-base in acciaio inox lucido o satinato, colonna in acciaio inox lucido o satinato, o faggio.
- > Table frame with base cover in glossy or satin stainless steel. Glossy or satin stainless steel, or beech wood column.
- > Pied de table avec capot pour embase en inox finition brillant ou satiné, colonne en inox finition brillant ou satiné, ou en hêtre.
- > Tisch mit Bodenplatte aus poliertem oder Matt Edelstahl, Säule aus poliertem oder Matt Edelstahl oder Buchenholz.
- > Pie de mesa con capa de la base en acero inox pulido o satinado, columna en acero inox pulido o satinado o en madera de haya.

Piani Tavolo / Table Tops / Plateaux De Table / Tischplatten / Sobres De Mesa
 Ø 80 cm
 Ø 90 cm
 80x80 cm
 90x90 cm

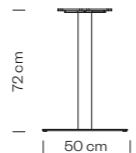

Peso / Weight / Poids / Gewicht / Peso **18,5 kg**

Imballo / Packaging / Emballage / Verpackung / Embalaje **0,05 m³**

Pezzi per scatola / Pieces per box / Pièces par carton / Stücke in einem Karton / Piezas por caja **1**



480A Q

- > Tavolo alto con copri-base in acciaio inox lucido o satinato, colonna in acciaio inox lucido o satinato.
- > High table frame with base cover in glossy or satin stainless steel. Glossy or satin stainless steel column.
- > Pied mange debout avec capot pour embase en inox finition brillant ou satiné, colonne en inox finition brillant ou satiné.
- > Stehtisch mit Bodenplatte aus poliertem oder Matt Edelstahl, Säule aus poliertem oder Matt Edelstahl.
- > Pie de mesa con capa de la base en acero inox pulido o satinado, columna en acero inox pulido o satinado. Mesa alta.

Piani Tavolo / Table Tops / Plateaux De Table / Tischplatten / Sobres De Mesa
 Ø 80 cm
 Ø 90 cm
 70x70 cm
 80x80 cm

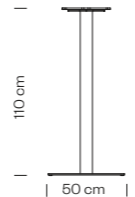

Peso / Weight / Poids / Gewicht / Peso **20 kg**

Imballo / Packaging / Emballage / Verpackung / Embalaje **0,05 m³**

Pezzi per scatola / Pieces per box / Pièces par carton / Stücke in einem Karton / Piezas por caja **2**



480A T

- > Tavolo alto con copri-base in acciaio inox lucido o satinato, colonna in acciaio inox lucido o satinato, o faggio.
- > High table frame with base cover in glossy or satin stainless steel, column in glossy, satin stainless steel or beech wood.
- > Pied mange debout avec capot pour embase en inox finition brillant ou satiné, colonne en inox finition brillant ou satiné, ou en hêtre.
- > Stehtisch mit Bodenplatte aus poliertem oder Matt Edelstahl, Säule aus poliertem oder Matt Edelstahl oder Buchenholz.
- > Pie de mesa con capa de la base en acero inox pulido o satinado, columna en acero inox pulido o satinado o en madera de haya. Mesa alta.

Piani Tavolo / Table Tops / Plateaux De Table / Tischplatten / Sobres De Mesa
 Ø 80 cm
 Ø 90 cm
 80x80 cm
 90x90 cm

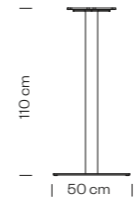

Peso / Weight / Poids / Gewicht / Peso **19,8 kg**

Imballo / Packaging / Emballage / Verpackung / Embalaje **0,05 m³**

Pezzi per scatola / Pieces per box / Pièces par carton / Stücke in einem Karton / Piezas por caja **2**



480B T

- > Tavolo basso con copri-base in acciaio inox lucido o satinato, colonna in acciaio inox lucido o satinato.
- > Low table frame with base cover in glossy or satin stainless steel. Glossy or satin stainless steel column.
- > Pied de table avec capot pour embase en inox finition brillant ou satiné, colonne en inox finition brillant ou satiné. Version hauteur 42,5 cm.
- > Niedriger Tisch mit Bodenplatte aus poliertem oder Matt Edelstahl, Säule aus poliertem oder Matt Edelstahl.
- > Pie de mesa con capa de la base en acero inox pulido o satinado, columna en acero inox pulido o satinado. Mesa baja.

Piani Tavolo / Table Tops / Plateaux De Table / Tischplatten / Sobres De Mesa
 Ø 80 cm
 Ø 90 cm
 80x80 cm
 90x90 cm

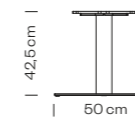

Peso / Weight / Poids / Gewicht / Peso **17,5 kg**

Imballo / Packaging / Emballage / Verpackung / Embalaje **0,05 m³**

Pezzi per scatola / Pieces per box / Pièces par carton / Stücke in einem Karton / Piezas por caja **1**



490Q

- > Tavolo con copri-base in acciaio inox lucido o satinato, colonna in acciaio inox lucido o satinato, o faggio.
- > Table frame with base cover in glossy or satin stainless steel. Glossy, satin stainless steel or beech wood column.
- > Pied de table avec capot pour embase en inox finition brillant ou satiné, colonne en inox finition brillant ou satiné, ou en hêtre.
- > Tisch mit Bodenplatte aus poliertem oder Matt Edelstahl, Säule aus poliertem oder Matt Edelstahl oder Buchenholz.
- > Pie de mesa con capa de la base en acero inox pulido o satinado, columna en acero inox pulido o satinado o en madera de haya.

Piani Tavolo / Table Tops / Plateaux De Table / Tischplatten / Sobres De Mesa
 70x120 cm
 70x130 cm
 80x120 cm
 80x130 cm
 80x140 cm

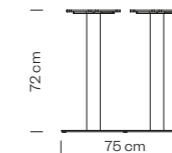

Peso / Weight / Poids / Gewicht / Peso **28,5 kg**

Imballo / Packaging / Emballage / Verpackung / Embalaje **0,06 m³**

Pezzi per scatola / Pieces per box / Pièces par carton / Stücke in einem Karton / Piezas por caja **1**



490T

- > Tavolo con copri-base in acciaio inox lucido o satinato, colonna in acciaio inox lucido o satinato, o faggio.
- > Table frame with base cover in glossy or satin stainless steel. Glossy, satin stainless steel or beech wood column.
- > Pied de table avec capot pour embase en inox finition brillant ou satiné, colonne en inox finition brillant ou satiné, ou en hêtre.
- > Tisch mit Bodenplatte aus poliertem oder Matt Edelstahl, Säule aus poliertem oder Matt Edelstahl oder Buchenholz.
- > Pie de mesa con capa de la base en acero inox pulido o satinado, columna en acero inox pulido o satinado o en madera de haya.

Piani Tavolo / Table Tops / Plateaux De Table / Tischplatten / Sobres De Mesa
 70x120 cm
 70x130 cm
 80x120 cm
 80x130 cm
 80x140 cm

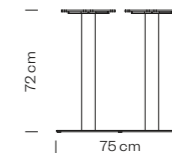

Peso / Weight / Poids / Gewicht / Peso **26,1 kg**

Imballo / Packaging / Emballage / Verpackung / Embalaje **0,06 m³**

Pezzi per scatola / Pieces per box / Pièces par carton / Stücke in einem Karton / Piezas por caja **1**



490A Q

- > Tavolo alto con copri-base in acciaio inox lucido o satinato, colonna in acciaio inox lucido o satinato.
- > High table frame with base cover in glossy or satin stainless steel, column in glossy or satin stainless steel.
- > Pied mange debout avec capot pour embase en inox finition brillant ou satiné, colonne en inox finition brillant ou satiné.
- > Stehtisch mit Bodenplatte aus poliertem oder Matt Edelstahl, Säule aus poliertem oder Matt Edelstahl.
- > Pie de mesa con capa de la base en acero inox pulido o satinado, columna en acero inox pulido o satinado. Mesa alta.

Piani Tavolo / Table Tops / Plateaux De Table / Tischplatten / Sobres De Mesa
70x120 cm
70x130 cm
80x120 cm
80x130 cm

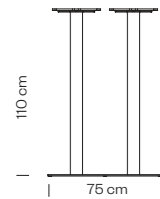

Peso / Weight / Poids / Gewicht / Peso **32,6 kg**

Imballo / Packaging / Emballage / Verpackung / Embalaje **0,06 m³**

Pezzi per scatola / Pieces per box / Pièces par carton / Stücke in einem Karton / Piezas por caja **1**



490A T

- > Tavolo alto con copri-base in acciaio inox lucido o satinato, colonna in acciaio inox lucido o satinato, o legno.
- > High table frame with base cover in glossy or satin stainless steel, column in glossy or satin stainless steel, or wood column.
- > Pied mange debout avec capot pour embase en inox finition brillant ou satiné, colonne en inox finition brillant ou satiné, ou en hêtre.
- > Stehtisch mit Bodenplatte aus poliertem oder Matt Edelstahl, Säule aus poliertem oder Matt Edelstahl oder Buchenholz.
- > Pie de mesa con capa de la base en acero inox pulido o satinado, columna en acero inox pulido o satinado o en madera de haya. Mesa alta.

Piani Tavolo / Table Tops / Plateaux De Table / Tischplatten / Sobres De Mesa
70x120 cm
70x130 cm
80x120 cm
80x130 cm

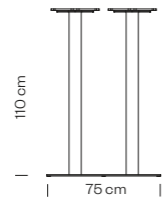

Peso / Weight / Poids / Gewicht / Peso **28,5 kg**

Imballo / Packaging / Emballage / Verpackung / Embalaje **0,06 m³**

Pezzi per scatola / Pieces per box / Pièces par carton / Stücke in einem Karton / Piezas por caja **1**



492

- > Tavolo con copri-base in acciaio inox lucido o satinato, colonna in acciaio inox lucido o satinato, o legno.
- > Table frame with base cover in glossy or satin stainless steel, column in glossy or satin stainless steel, or wood column.
- > Pied de table avec capot pour embase en inox finition brillant ou satiné, colonne en inox finition brillant ou satiné, ou en hêtre.
- > Tisch mit Bodenplatte aus poliertem oder Matt Edelstahl, Säule aus poliertem oder Matt Edelstahl oder Buchenholz.
- > Pie de mesa con capa de la base en acero inox pulido o satinado, columna en acero inox pulido o satinado o en madera de haya.

Piani Tavolo / Table Tops / Plateaux De Table / Tischplatten / Sobres De Mesa
Ø 110 cm
Ø 120 cm
Ø 130 cm
100x100 cm
110x110 cm

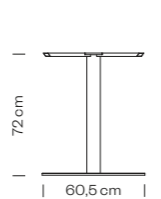

Peso / Weight / Poids / Gewicht / Peso **30,7 kg**

Imballo / Packaging / Emballage / Verpackung / Embalaje **0,06 m³**

Pezzi per scatola / Pieces per box / Pièces par carton / Stücke in einem Karton / Piezas por caja **1**



494

- > Tavolo con copri-base in acciaio inox lucido o satinato, colonna in acciaio inox lucido o satinato.
- > Table frame with base cover in glossy or satin stainless steel, column in glossy or satin stainless steel.
- > Pied de table avec capot pour embase en inox finition brillant ou satiné.
- > Tisch mit Bodenplatte aus poliertem oder Matt Edelstahl, Säule aus poliertem oder Matt Edelstahl.
- > Pie de mesa con capa de la base en acero inox pulido o satinado, columna en acero inox pulido o satinado.

Piani Tavolo / Table Tops / Plateaux De Table / Tischplatten / Sobres De Mesa
Ø 60 cm
Ø 70 cm
60x60 cm

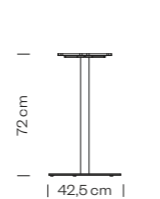

Peso / Weight / Poids / Gewicht / Peso **11,7 kg**

Imballo / Packaging / Emballage / Verpackung / Embalaje **0,06 m³**

Pezzi per scatola / Pieces per box / Pièces par carton / Stücke in einem Karton / Piezas por caja **2**



494A

- > Tavolo alto con copri-base in acciaio inox lucido o satinato, colonna in acciaio inox lucido o satinato.
- > High table frame with base cover in glossy or satin stainless steel, column in glossy or satin stainless steel.
- > Pied mange debout avec capot pour embase en inox finition brillant ou satiné, colonne en inox finition brillant ou satiné.
- > Stehtisch mit Bodenplatte aus poliertem oder Matt Edelstahl, Säule aus poliertem oder Matt Edelstahl.
- > Pie de mesa con capa de la base en acero inox pulido o satinado, columna en acero inox pulido o satinado. Mesa alta.

Piani Tavolo / Table Tops / Plateaux De Table / Tischplatten / Sobres De Mesa
Ø 60 cm
Ø 70 cm
60x60 cm

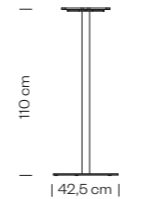

Peso / Weight / Poids / Gewicht / Peso **12,6 kg**

Imballo / Packaging / Emballage / Verpackung / Embalaje **0,06 m³**

Pezzi per scatola / Pieces per box / Pièces par carton / Stücke in einem Karton / Piezas por caja **2**



495Q

- > Tavolo con copri-base in acciaio inox lucido o satinato, colonna in acciaio inox lucido o satinato.
- > Table frame with base cover in glossy or satin stainless steel, column in glossy or satin stainless steel.
- > Pied de table avec capot pour embase en inox finition brillant ou satiné.
- > Tisch mit Bodenplatte aus poliertem oder Matt Edelstahl, Säule aus poliertem oder Matt Edelstahl.
- > Pie de mesa con capa de la base en acero inox pulido o satinado, columna en acero inox pulido o satinado.

Piani Tavolo / Table Tops / Plateaux De Table / Tischplatten / Sobres De Mesa
Ø 60 cm
Ø 70 cm
60x60 cm
70x70 cm

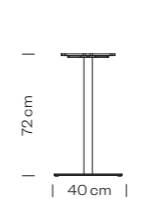

Peso / Weight / Poids / Gewicht / Peso **13 kg**

Imballo / Packaging / Emballage / Verpackung / Embalaje **0,06 m³**

Pezzi per scatola / Pieces per box / Pièces par carton / Stücke in einem Karton / Piezas por caja **2**



495T

- > Tavolo con copri-base in acciaio inox lucido o satinato, colonna in acciaio inox lucido o satinato.
- > Table frame with base cover in glossy or satin stainless steel, column in glossy or satin stainless steel.
- > Pied de table avec capot pour embase en inox finition brillant ou satiné.
- > Tisch mit Bodenplatte aus poliertem oder Matt Edelstahl, Säule aus poliertem oder Matt Edelstahl.
- > Pie de mesa con capa de la base en acero inox pulido o satinado, columna en acero inox pulido o satinado.

Piani Tavolo / Table Tops / Plateaux De Table / Tischplatten / Sobres De Mesa
Ø 60 cm
Ø 70 cm
60x60 cm
70x70 cm

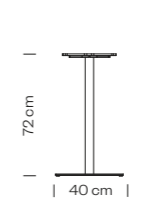

Peso / Weight / Poids / Gewicht / Peso **12,7 kg**

Imballo / Packaging / Emballage / Verpackung / Embalaje **0,06 m³**

Pezzi per scatola / Pieces per box / Pièces par carton / Stücke in einem Karton / Piezas por caja **2**



495A Q

- > Tavolo alto con copri-base in acciaio inox lucido o satinato, colonna in acciaio inox lucido o satinato.
- > High table frame with base cover in glossy or satin stainless steel, column in glossy or satin stainless steel.
- > Pied mange debout avec capot pour embase en inox finition brillant ou satiné, colonne en inox finition brillant ou satiné.
- > Stehtisch mit Bodenplatte aus poliertem oder Matt Edelstahl, Säule aus poliertem oder Matt Edelstahl.
- > Pie de mesa con capa de la base en acero inox pulido o satinado, columna en acero inox pulido o satinado. Mesa alta.

Piani Tavolo / Table Tops / Plateaux De Table / Tischplatten / Sobres De Mesa
Ø 60 cm
Ø 70 cm
60x60 cm

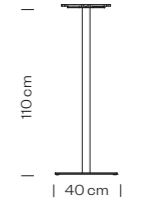

Peso / Weight / Poids / Gewicht / Peso **14,1 kg**

Imballo / Packaging / Emballage / Verpackung / Embalaje **0,06 m³**

Pezzi per scatola / Pieces per box / Pièces par carton / Stücke in einem Karton / Piezas por caja **2**



495A T

- > Tavolo alto con copri-base in acciaio inox lucido o satinato, colonna in acciaio inox lucido o satinato.
- > High table frame with base cover in glossy or satin stainless steel, column in glossy or satin stainless steel.
- > Pied mange debout avec capot pour embase en inox finition brillant ou satiné, colonne en inox finition brillant ou satiné.
- > Stehtisch mit Bodenplatte aus poliertem oder Matt Edelstahl, Säule aus poliertem oder Matt Edelstahl.
- > Pie de mesa con capa de la base en acero inox pulido o satinado, columna en acero inox pulido o satinado. Mesa alta.

Piani Tavolo / Table Tops /
Plateaux De Table / Tischplatten /
Sobres De Mesa
Ø 60 cm
Ø 70 cm
60x60 cm

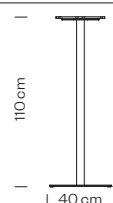

Peso / Weight /
Poids / Gewicht / Peso **13,6 kg**

Imballo / Packaging /
Emballage / Verpackung /
Embalaje **0,06 m³**

Pezzi per scatola /
Pieces per box /
Pièces par carton /
Stücke in einem Karton /
Piezas por caja **2**



496Q

- > Tavolo con copri-base in acciaio inox lucido o satinato, colonna in acciaio inox lucido o satinato.
- > Table frame with base cover in glossy or satin stainless steel, column in glossy or satin stainless steel.
- > Pied de table avec capot pour embase en inox finition brillant ou satiné, colonne en inox finition brillant ou satiné.
- > Tisch mit Bodenplatte aus poliertem oder Matt Edelstahl, Säule aus poliertem oder Matt Edelstahl.
- > Pie de mesa con capa de la base en acero inox pulido o satinado, columna en acero inox pulido o satinado.

Piani Tavolo / Table Tops /
Plateaux De Table / Tischplatten /
Sobres De Mesa
70x120 cm
70x130 cm
80x120 cm
80x130 cm

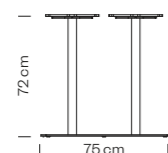

Peso / Weight /
Poids / Gewicht / Peso **25,7 kg**

Imballo / Packaging /
Emballage / Verpackung /
Embalaje **0,06 m³**

Pezzi per scatola /
Pieces per box /
Pièces par carton /
Stücke in einem Karton /
Piezas por caja **1**



496T

- > Tavolo con copri-base in acciaio inox lucido o satinato, colonna in acciaio inox lucido o satinato.
- > Table frame with base cover in glossy or satin stainless steel, column in glossy or satin stainless steel.
- > Pied de table avec capot pour embase en inox finition brillant ou satiné.
- > Tisch mit Bodenplatte aus poliertem oder Matt Edelstahl, Säule aus poliertem oder Matt Edelstahl.
- > Pie de mesa con capa de la base en acero inox pulido o satinado, columna en acero inox pulido o satinado.

Piani Tavolo / Table Tops /
Plateaux De Table / Tischplatten /
Sobres De Mesa
70x120 cm
70x130 cm
80x120 cm
80x130 cm

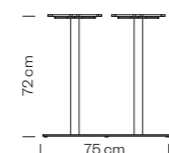

Peso / Weight /
Poids / Gewicht / Peso **24,5 kg**

Imballo / Packaging /
Emballage / Verpackung /
Embalaje **0,06 m³**

Pezzi per scatola /
Pieces per box /
Pièces par carton /
Stücke in einem Karton /
Piezas por caja **1**



496A Q

- > Tavolo alto con copri-base in acciaio inox lucido o satinato, colonna in acciaio inox lucido o satinato.
- > High table frame with base cover in glossy or satin stainless steel, column in glossy or satin stainless steel.
- > Pied mange debout avec capot pour embase en inox finition brillant ou satiné, colonne en inox finition brillant ou satiné.
- > Stehtisch mit Bodenplatte aus poliertem oder Matt Edelstahl, Säule aus poliertem oder Matt Edelstahl.
- > Pie de mesa con capa de la base en acero inox pulido o satinado, columna en acero inox pulido o satinado. Mesa alta.

Piani Tavolo / Table Tops /
Plateaux De Table / Tischplatten /
Sobres De Mesa
70x120 cm
70x130 cm
80x120 cm
80x130 cm

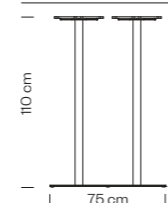

Peso / Weight /
Poids / Gewicht / Peso **28 kg**

Imballo / Packaging /
Emballage / Verpackung /
Embalaje **0,06 m³**

Pezzi per scatola /
Pieces per box /
Pièces par carton /
Stücke in einem Karton /
Piezas por caja **1**



496A T

- > Tavolo alto con copri-base in acciaio inox lucido o satinato, colonna in acciaio inox lucido o satinato.
- > High table frame with base cover in glossy or satin stainless steel, column in glossy or satin stainless steel.
- > Pied mange debout avec capot pour embase en inox finition brillant ou satiné, colonne en inox finition brillant ou satiné.
- > Stehtisch mit Bodenplatte aus poliertem oder Matt Edelstahl, Säule aus poliertem oder Matt Edelstahl.
- > Pie de mesa con capa de la base en acero inox pulido o satinado, columna en acero inox pulido o satinado. Mesa alta.

Piani Tavolo / Table Tops /
Plateaux De Table / Tischplatten /
Sobres De Mesa
70x120 cm
70x130 cm
80x120 cm
80x130 cm

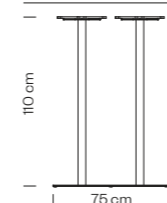

Peso / Weight /
Poids / Gewicht / Peso **26,3 kg**

Imballo / Packaging /
Emballage / Verpackung /
Embalaje **0,06 m³**

Pezzi per scatola /
Pieces per box /
Pièces par carton /
Stücke in einem Karton /
Piezas por caja **1**



**Accessori / Accessories /
Accessoires / Zubehoer /
Accessorios**

Piedini Regolabili H 12 mm /
H 12 mm adjustable feet /
Vérins réglables H 12 mm /
Verstellgleitern H. 12 mm /
Pies niveladores H 12 mm

AX

- > Finiture telaio (vedi p. 396)
- > Frame finishes (see p. 396)
- > Finitions piètement (voir p. 396)
- > Gestell fertigungen (sehen S. 396)
- > Acabados estructura (ver p. 396)

LE

- > Finiture telaio
- > Frame finishes
- > Finitions piètement
- > Gestell fertigungen
- > Acabados estructura

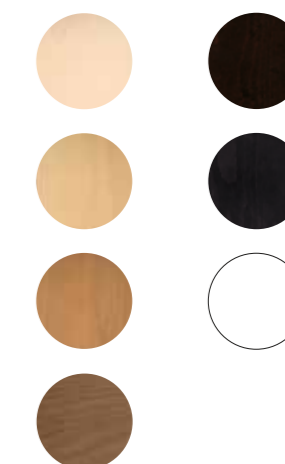

tipologie piani tavoli / top types / types de plateaux / tischplatten modellen / tipo de sobres de mesa

LAM

laminato / laminate / stratifié / laminat / laminado

b gp

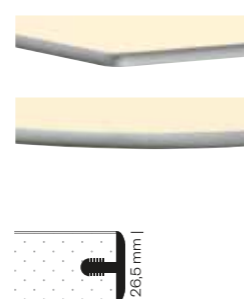
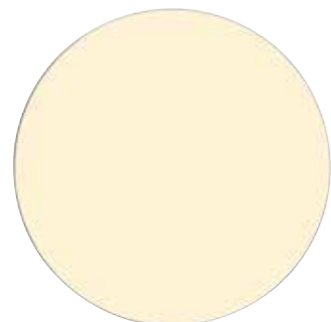

Piano in laminato con bordo gomma
piatto colore alluminio /
Laminate table top with flat rubber
edge in aluminium colour /
Plateau en stratifié avec bord en
caoutchouc plat couleur aluminium /
Laminat Tischplatte mit flache PVC
Kante Aluminium farbig /
Sobre de mesa en laminado con borde
de hule plano color aluminio

s2

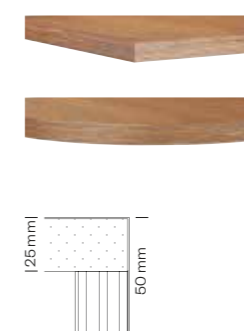

Piano e bordo in laminato / Laminate
table top with laminate edge /
Plateau en stratifié avec bord en
stratifié / Laminat Tischplatte mit
Kante aus Laminat / Sobre de mesa en
laminado con borde en laminado

b lam

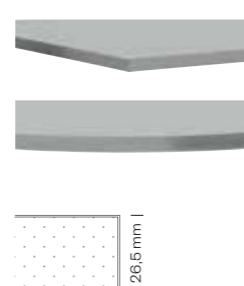

Piano e bordo in laminato / Laminate
table top with laminate edge / Plateau
en stratifié avec bord en stratifié /
Laminat Tischplatte mit Kante aus
Laminat / Sobre de mesa en laminado
con borde en laminado

s2 abs

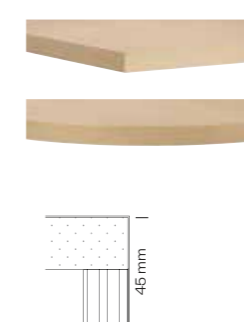

Piano in laminato, con bordo in ABS
colore rovere, wengé o bianco /
Table top laminate with oak, wengé or
white coloured ABS edge /
Plateau en stratifié avec bord en ABS,
couleurs chêne, wengé ou blanc /
Laminat Tischplatte mit ABS Kante,
Wengé, Eiche oder Weiss /
Sobre de mesa en laminado con borde
en ABS roble, wengé o blanco

b abs

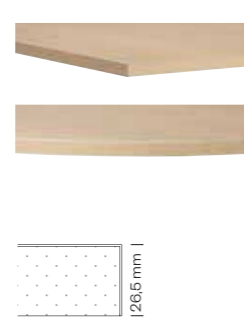

Piano in laminato, con bordo in ABS
colore rovere, wengé o bianco /
Table top laminate with oak, wengé or
white coloured ABS edge /
Plateau en stratifié avec bord en ABS,
couleurs chêne, wengé ou blanc /
Laminat Tischplatte mit ABS Kante,
Wengé, Eiche oder Weiss /
Sobre de mesa en laminado con borde
en ABS roble, wengé o blanco

60°R

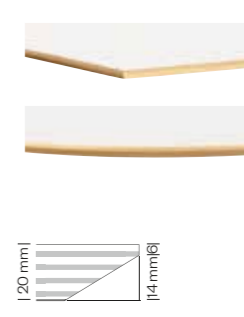

Piano in multistrato rivestito
in laminato con bordo 60°R in faggio /
Laminate plywood table top with 60°
reversed beech edge / Plateau plaqué
bois, avec dessus en stratifié
et bord aile d'avion / Laminat
Tischplatte mit 60°R buchen Kante /
Sobre en multicapa cubierto en
laminado con borde de haya 60°R

tipologie piani tavoli / top types /
types de plateaux / tischplatten
modellen / tipo de sobres de mesa

STR

stratificato HPL / HPL solid laminate / stratifié HPL /
HPL compactplatte / estratificado HPL

compact

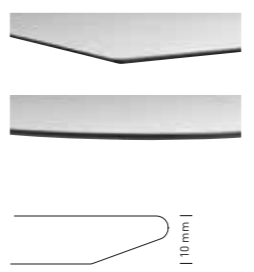
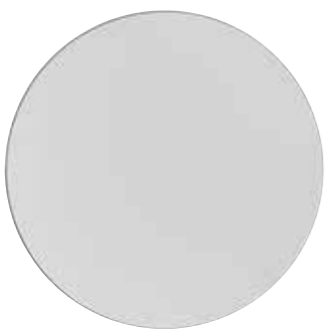

Piani tavoli in stratificato 10 mm /
10 mm compact laminate table tops /
Plateau en stratifié compact 10 mm /
Mehrschicht Platte für Außenbereich
Stärke 10 mm / Sobres de mesas en
estratificado 10 mm



full colour

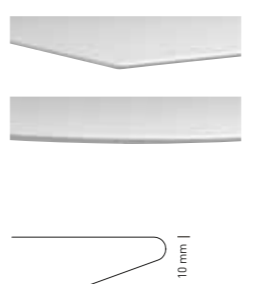
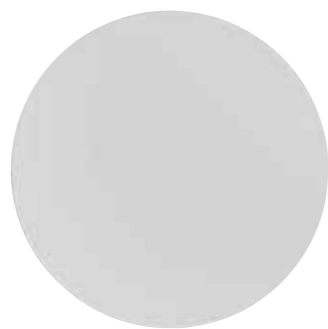

Piani tavoli in stratificato 10 mm /
10 mm compact laminate table tops /
Plateau en stratifié compact 10 mm /
Mehrschicht Platte für Außenbereich
Stärke 10 mm / Sobres de mesas
en estratificado 10 mm



WRZ

werzalit

WRZ

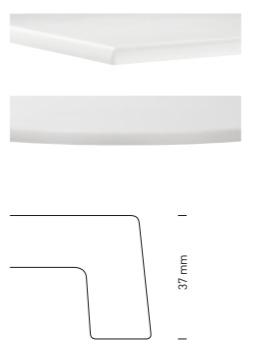

Piani per esterno in resina stampati
ad alta pressione rivestiti con film
decorativo / Resin-coated top for
outdoor use / Plateau avec revêtement
en résine pour utilisation en extérieur /
Tischplatte aus Harz für den
Aussenbereich / Sobre de mesa en
resina para utilización ex exteriores



finiture sedute /
seating finishes /
finitions des sièges /
sitzfertigungen /
acabados asientos

materiale plastico /
plastic material / matériel plastic /
kunststoff / material plástico

PA

poliammide / polyamide / polyamide / polyamid / poliamida



flint



RAL 9010
Bianco puro / Pure
white / Blanc pur /
Reinweiß / Blanco puro

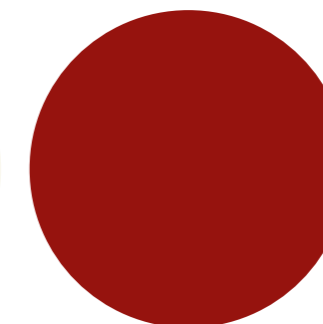

RAL 3003
Rosso rubino / Ruby
red / Rouge rubis /
Rubinrot / Rojo rubí

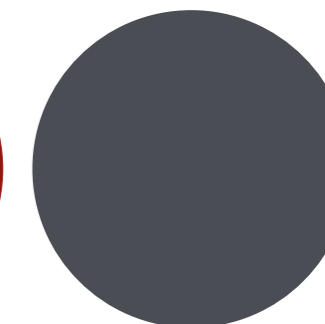

RAL 7016
Grigio antracite /
Anthracite grey /
Gris anthracite /
Anthrazitgrau /
Gris antracita

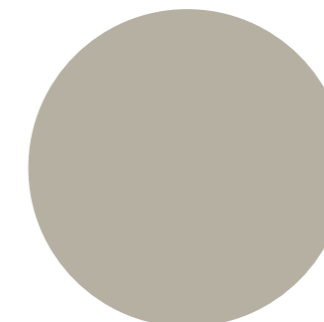

PANTONE 402 C
Tortora / Turtle-dove /
Gris tourterelle /
Taubengrau / Tortora

PE

polietilene rotazionale / roto-moulding polyethylene /
polyéthylène moulé à rotation / rotationsverfahren
gepresstem polyäthylen / polietileno moldeado rotativo



apple / boom



PANTONE 427 C
Bianco ghiaccio /
Ice white / Blanc glace /
Eis weiss / Blanco hielo

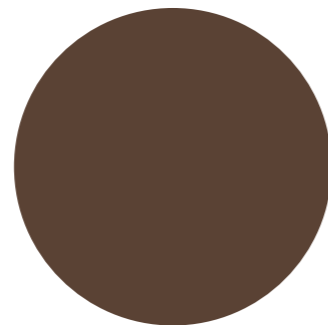

RAL 8017
Marrone cioccolata /
Chocolate brown /
Brun chocolat /
Schokoladenbraun /
Chocolate

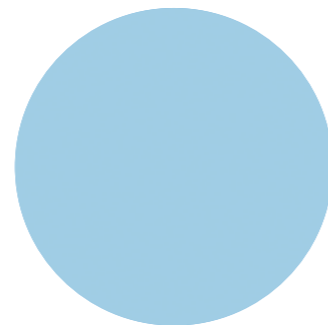

NCS S0530-R90B
Celeste / Sky-blue /
Bleu Clair / Hellblau /
Celeste

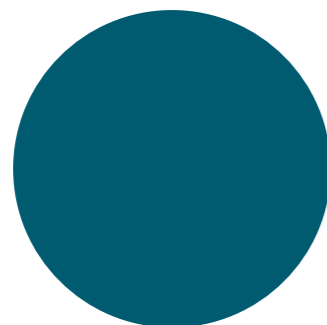

RAL 5021
Blu acqua / Water blue /
Bleu d'eau / Wasserblau /
Azul agua

playa



PANTONE 427 C
Bianco ghiaccio /
Ice white / Blanc glace /
Eis weiss / Blanco hielo

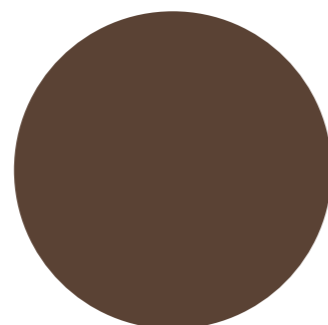

RAL 8017
Marrone cioccolata /
Chocolate brown / Brun
chocolat / Schokoladenbraun /
Chocolate

pif

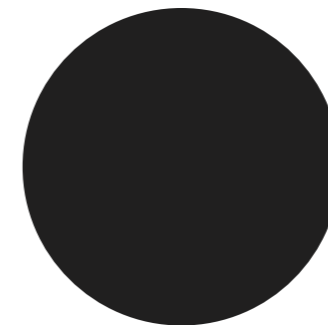

RAL 9004
Nero segnale / Signal
black / Signalschwarz /
Noir de sécurité / Negro
señales

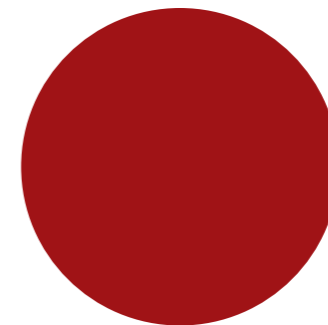

RAL 3003
Rosso rubino /
Ruby red / Rouge
rubis / Rubinrot /
Rojo rubí

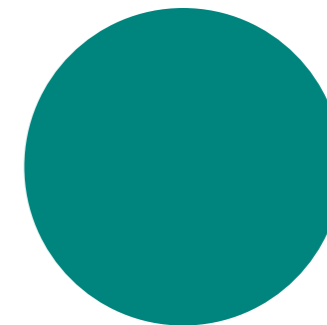

RAL 6033
Turchese menta / Mint
turquoise / Turquoise
menthe / Minttürkis /
Turquesa menta

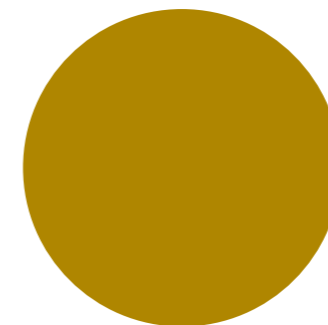

RAL 1027
Giallo curry / Curry /
Jaune curry /
Currygelb /
Amarillo curry

PP

polipropilene / polypropylene /
polypropylène / polypropylen / polipropileno



bikini



RAL 9010
Bianco puro /
Pure white /
Blanc pur / Reinweiß /
Blanco puro

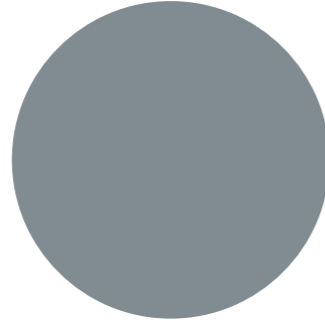

RAL 7000
Grigio vaio / Squirrel
grey / Gris petit-gris /
Fehgrau / Gris ardilla

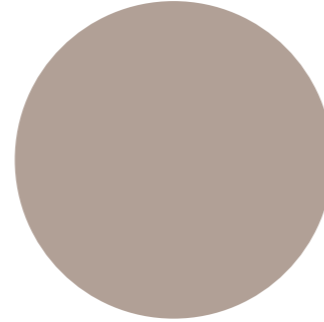

PANTONE 402 C
Tortora / Turtle-dove /
Gris tourterelle /
Taubengrau / Tortora

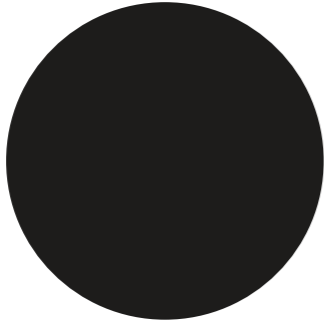

RAL 9005
Nero intenso / Jet black /
Noir foncé / Tiefschwarz /
Negro intenso

cuba

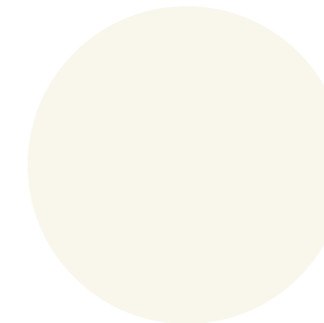

RAL 9010
Bianco puro /
Pure white /
Blanc pur / Reinweiß /
Blanco puro

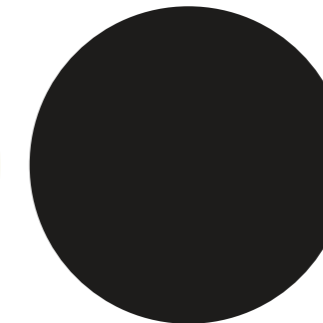

RAL 9005
Nero intenso / Jet
black / Noir foncé /
Tiefschwarz /
Negro intenso

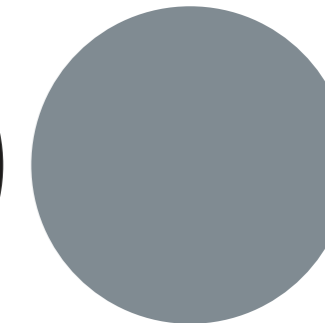

RAL 7000
Grigio vaio / Squirrel
grey / Gris petit-gris /
Fehgrau / Gris ardilla

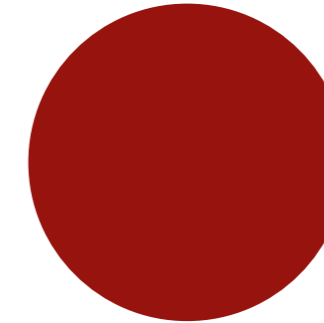

RAL 3003
Rosso rubino / Ruby red /
Rouge rubis / Rubinrot /
Rojo rubí

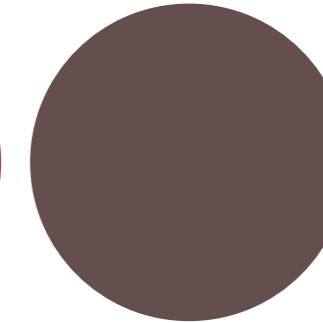

PANTONE 411 C
Argilla / Clay / Argile /
Ton / Arcilla

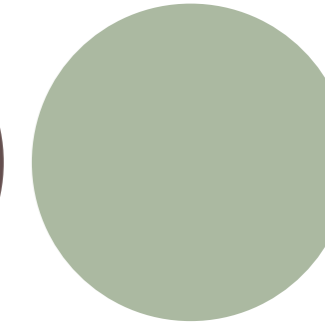

NCS S3010-G30Y
Pistacchio /
Pistachio / Pistache /
Pistazie / Pistacho

maré



RAL 9010
Bianco puro / Pure
white / Blanc pur /
Reinweiß / Blanco puro

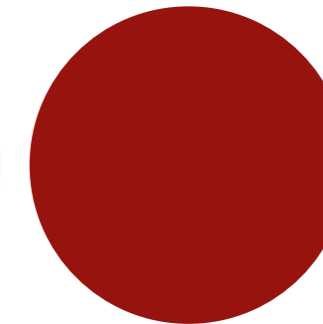

RAL 3003
Rosso rubino / Ruby
red / Rouge rubis /
Rubinrot / Rojo rubí

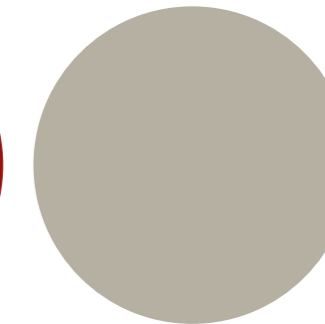

PANTONE 402 C
Tortora / Turtle-dove /
Gris tourterelle /
Taubengrau / Tortora

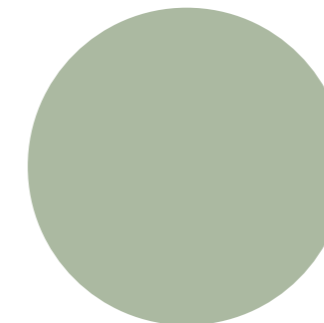

NCS S3010-G30Y
Pistacchio /
Pistachio / Pistache /
Pistazie / Pistacho

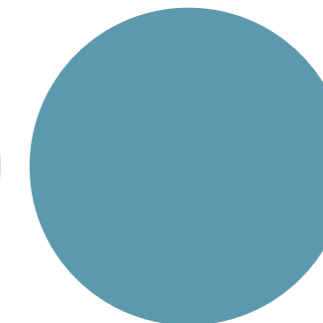

PANTONE 549 C
Blu polvere / Dusty
blue / Bleu poudre /
Stauben Blau / Azúl
polvo

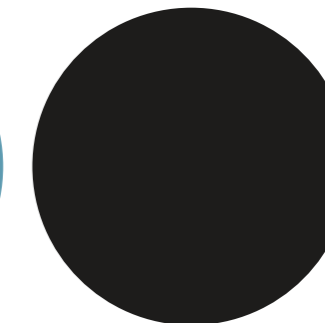

RAL 9005
Nero intenso / Jet
black / Noir foncé /
Tiefschwarz /
Negro intenso

nassau

* Non disponibile per / Not available for / Pas disponible pour / Nicht verfügbar für / No disponible para 537, 537B



RAL 9010
Bianco puro / Pure white / Blanc pur / Reinweiß / Blanco puro

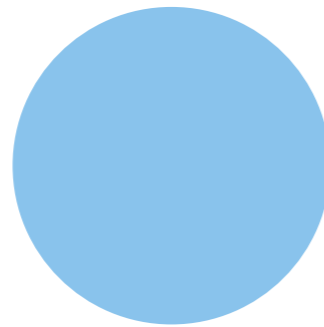

* PANTONE 283 C
Celeste / Sky-blue / Bleu clair / Hellblau / Celeste

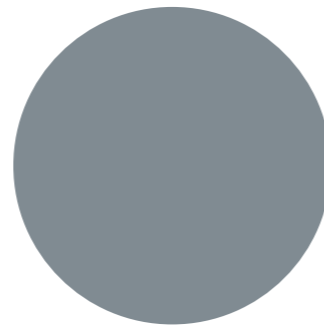

RAL 7000
Grigio vaio / Squirrel grey / Gris petit-gris / Fehgrau / Gris ardilla

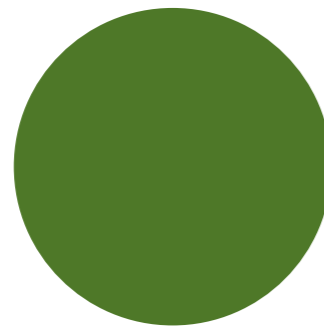

* RAL 6010
Verde erba / Grass green / Vert herbe / Grasgrün / Verde hierba

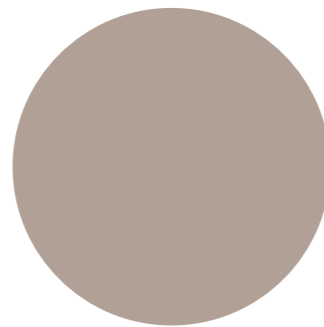

NCS S4005-Y50R
Tortora / Turtle-dove / Gris tourterelle / Taubengrau / Tortora

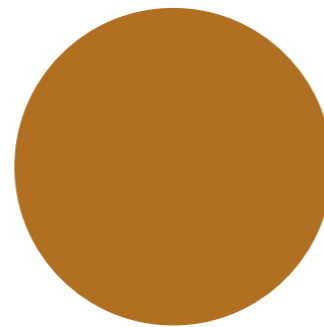

* RAL 8001
Marrone ocre / Ochre brown / Brun terre de Sienna / Ockerbraun / Pardo ocre

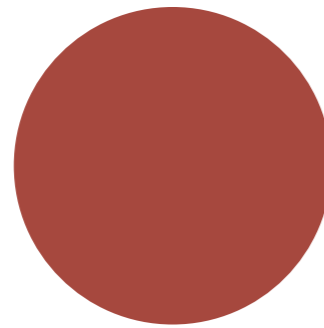

PANTONE 18-1438
Marsala / Marsala / Marsala / Marsala / Marsala

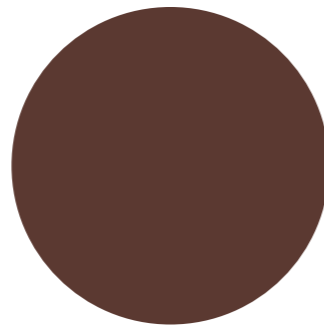

NCS S7005-Y50R
Cacao / Cocoa / Cacao / Kakao / Cacao

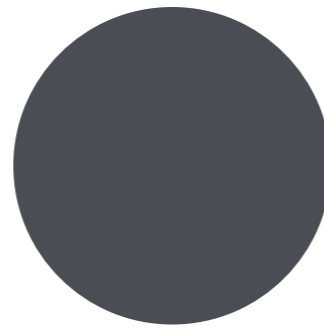

RAL 7016
Grigio antracite / Anthracite grey / Gris anthracite / Anthrazitgrau / Gris antracita

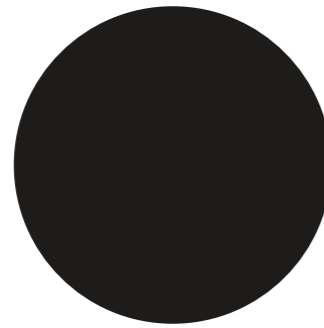

RAL 9005
Nero intenso / Jet black / Noir foncé / Tiefschwarz / Negro intenso

nassau 533

Versione ignifuga disponibile solo nel colore / Fire retardant version available in the colour / Version ignifugé disponible en couleur / Schwer entflammbar Ausführung verfügbar in den Farbe / Versión ignifuga disponible solamente en color



RAL 9010
Bianco puro / Pure white / Blanc pur / Reinweiß / Blanco puro

palau



RAL 9010
Bianco puro / Pure white / Blanc pur / Reinweiß / Blanco puro

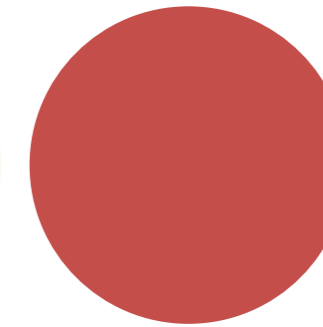

NCS S 2060-Y90R
Rosso corallo / Coral red / Rouge corail / Korallenrot / Rojo coral

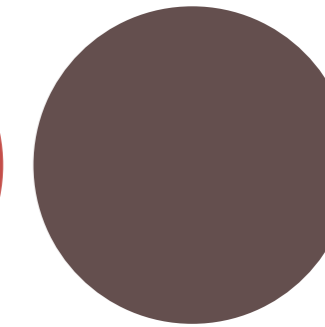

PANTONE 411 C
Argilla / Clay / Argile / Ton / Arcilla

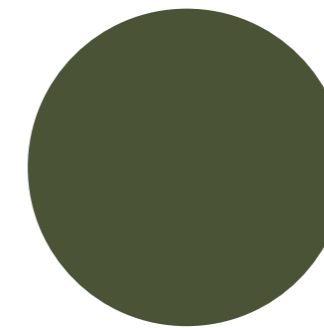

RAL 6003
Verde oliva / Olive green / Vert olive / Olivgrün / Verde oliva

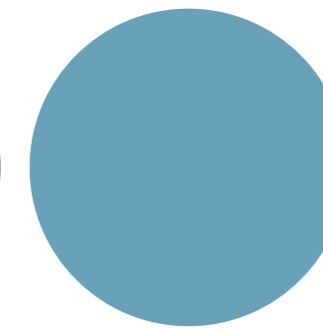

PANTONE 549 C
Blu polvere / Dusty blue / Bleu poudre / Stauben Blau / Azul polvo

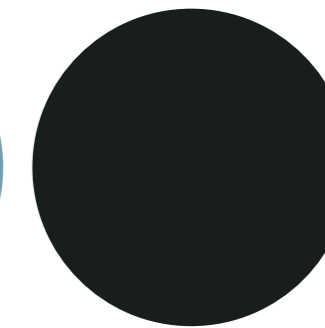

RAL 9011
Nero grafite / Graphite black / Noir graphite / Graphitschwarz / Negro grafito

uni



RAL 9016
Bianco traffico / Traffic
white / Blanc signalisation /
Verkehrsweiß / Blanco
tráfico

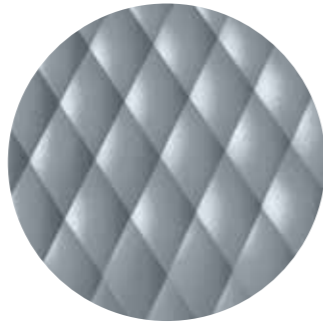

RAL 7000
Grigio vaio / Squirrel
grey / Gris petit-gris /
Fehgrau / Gris ardilla

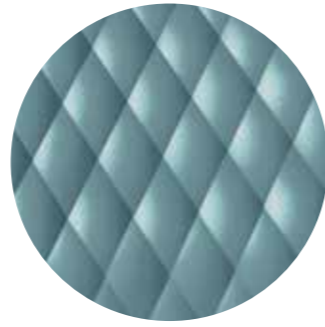

PANTONE 549 C
Blu polvere / Dusty blue /
Bleu poudre / Stauben
Blau / Azúl polvo



PANTONE 411 C
Argilla / Clay / Argile /
Ton / Arcilla



NCS S4005-Y50R
Tortora / Turtle-dove /
Gris tourterelle /
Taubengrau / Tortora

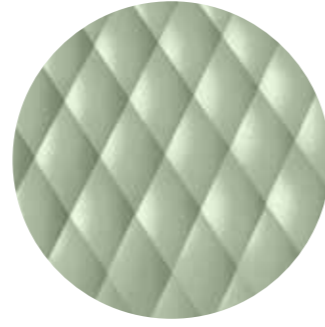

NCS S3010-G30Y
Pistacchio /
Pistachio / Pistache /
Pistazie / Pistacho



RAL 9005
Nero intenso /
Jet black / Noir foncé
Tiefschwarz / Negro
intenso



RAL 7016
Grigio antracite /
Anthracite grey / Gris
anthracite / Anthrazitgrau /
Gris antracita



NCS S 2060-Y90R
Rosso corallo /
Coral red / Rouge corail /
Korallenrot / Rojo coral



RAL 1004
Giallo oro / Golden
yellow / Jaune or /
Goldgelb / Amarillo oro

uni-ka



RAL 9016
Bianco traffico / Traffic
white / Blanc signalisation /
Verkehrsweiß / Blanco
tráfico

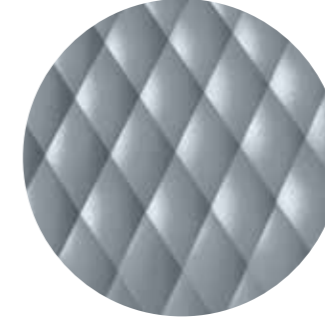

RAL 7000
Grigio vaio / Squirrel
grey / Gris petit-gris /
Fehgrau / Gris ardilla

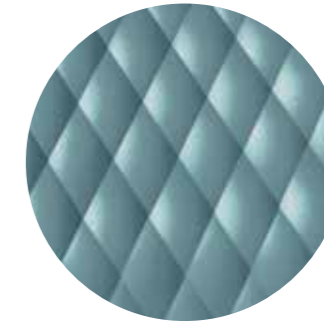

PANTONE 549 C
Blu polvere / Dusty blue /
Bleu poudre / Stauben
Blau / Azúl polvo

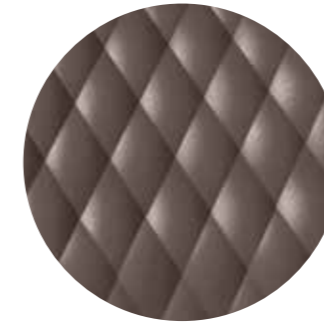

PANTONE 411 C
Argilla / Clay / Argile /
Ton / Arcilla

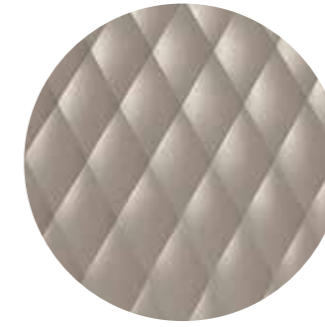

NCS S4005-Y50R
Tortora / Turtle-dove /
Gris tourterelle /
Taubengrau / Tortora

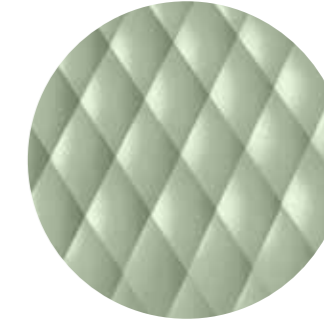

NCS S3010-G30Y
Pistacchio /
Pistachio / Pistache /
Pistazie / Pistacho



RAL 9005
Nero intenso /
Jet black / Noir foncé
Tiefschwarz / Negro
intenso



RAL 7016
Grigio antracite /
Anthracite grey / Gris
anthracite / Anthrazitgrau /
Gris antracita

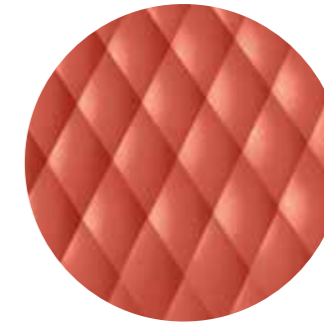

NCS S 2060-Y90R
Rosso corallo /
Coral red / Rouge corail /
Korallenrot / Rojo coral

PP +
PET

tecnopolimero composito multistrato a densità variabile / technopolymer, multi-layer variable density / techno-polymère composite multicouche à densité variable / zusammengesetztes mehrschichtiges technopolymere mit wechselbarer dichte / tecnopolímero compuesto multicapas de densidad variable



echo

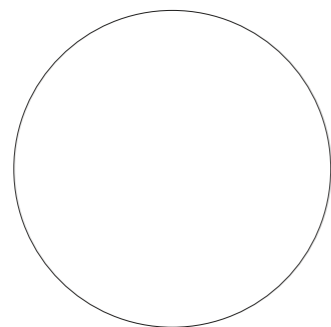

RAL 9016
Bianco traffico / Traffic white / Blanc signalisation / Verkehrsweiß / Blanco tráfico

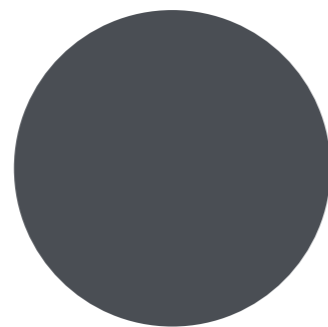

RAL 7016
Grigio antracite / Anthracite grey / Gris anthracite / Anthrazitgrau / Gris antracita

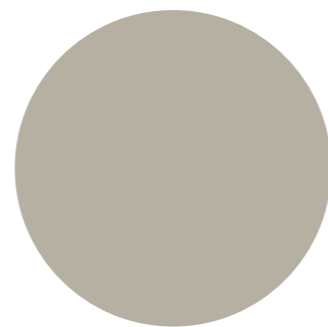

PANTONE 402 C
Tortora / Turtle-Dove / Gris Tourterelle / Taubengrau / Tortora

ibis

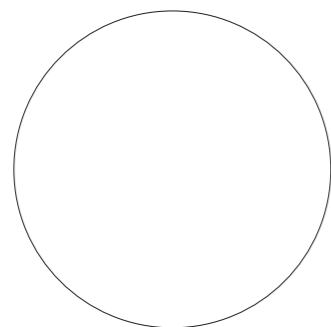

RAL 9016
Bianco traffico / Traffic white / Blanc signalisation / Verkehrsweiß / Blanco tráfico

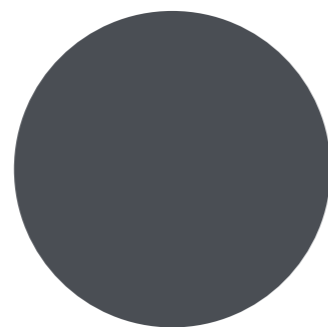

RAL 7016
Grigio antracite / Anthracite grey / Gris anthracite / Anthrazitgrau / Gris antracita

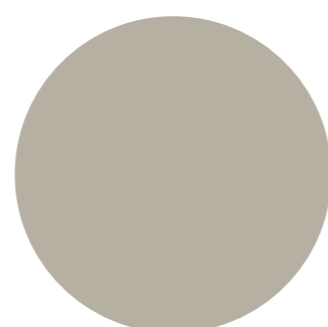

PANTONE 402 C
Tortora / Turtle-Dove / Gris Tourterelle / Taubengrau / Tortora

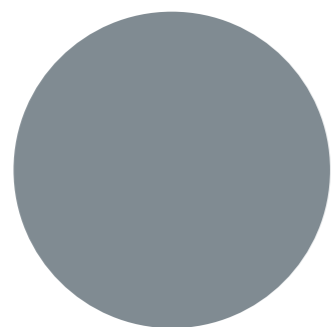

RAL 7000
Grigio vaio / Squirrel grey / Gris spetit-gris / Fehgrau / Gris ardilla

XLP

xiloplast / xiloplast / xiloplast / xiloplast / xiloplast



001



Bianco / White / Blanc / Weiss / Blanco



Nero 1 / Black 1 / Noir 1 / Schwarz 1 / Negro 1

legno / wood / bois /
holz / madera

LE

**hull*/
duo/
luna**

* finitura goffrata /
embossed finish /
finition goffré /
geprägte Ausführung /
acabado gofrado



Faggio tinto acero /
Maple stained beech
wood / Hêtre teinté
érable / Buche
Ahorn gefärbt /
Haya tenida arce



Faggio naturale /
Natural beech wood /
Hêtre naturel /
Buche Natur /
Haya natural



Faggio tinto rovere /
Oak stained beech
wood / Hêtre teinté
chêne / Buche Eiche
gefärbt / Haya tenida
roble



Faggio tinto noce
canaletto / Canaletto
Walnut stained beech
wood / Hêtre teinté
noyer canaletto / Buche
Nussbaum Canaletto
gefärbt / Haya tenida
nogal Canaletto



Faggio tinto wengé /
Wengé stained beech
wood / Hêtre teinté
wengé / Buche
wengé gefärbt /
Haya tenida wengé



Faggio tinto nero /
Black stained beech
wood / Hêtre teinté
noir / Buche
Schwarz gefärbt /
Haya tenida negro

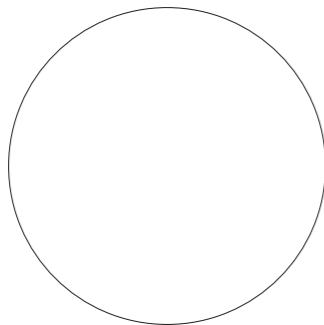

Faggio tinto campione / Beech wood, stained
according to sample / Hêtre teinté selon échantillon /
Kundenmuster gefärbt / Haya tenida según muestra

Ordine minimo 10 pz / Minimum order 10 pcs /
Minimum de commande 10 pièces / Mindestbestell
10 Stück / Mínimo de compra 10 piezas

flint



Iroko / Iroko / Iroko /
Iroko / Iroko

acciaio / steel / acier /
stahl / acero

AC

Per finiture Shade, Net e Stripes, vedi colori disponibili a p. 391 / For Shade, Net and Stripes finishes, see available colours, p. 391 / Pour les finitions de Shade, Net et Stripes, couleurs disponibles à la p. 391 / Für Shade, Net und Stripes siehe Farben auf S. 391 / Para acabados Shade, Net y Stripes ver los colores disponibles en la p. 391

tessuti / fabrics / tissus /
stoffe / tejidos

TE

cat. **a**



sawana
davis

Non utilizzabile per Uni, Uni-Ka e Nassau imbottite / Not suitable for upholstered Uni, Uni-Ka and Nassau / Pas disponible dans la version rembourrée des modèles Uni, Uni-Ka et Nassau / Nicht benutzbar für die gepolsterten Uni, Uni-Ka und Nassau / No utilizable para Uni, Uni-Ka y Nassau tapizadas

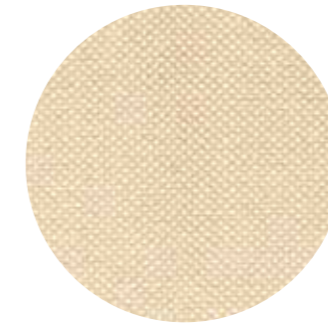

01

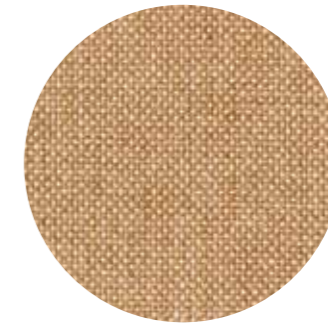

22

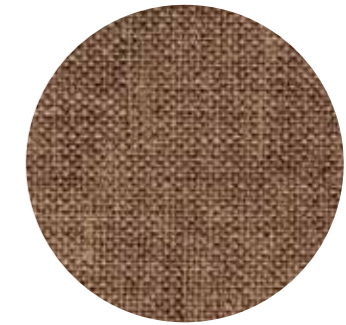

25

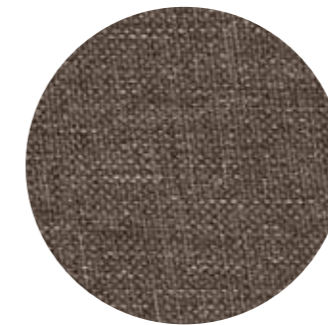

02

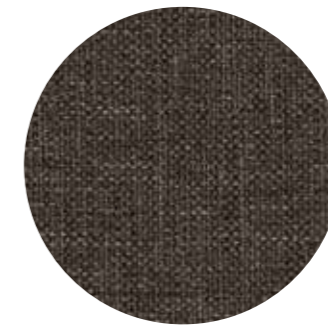

03

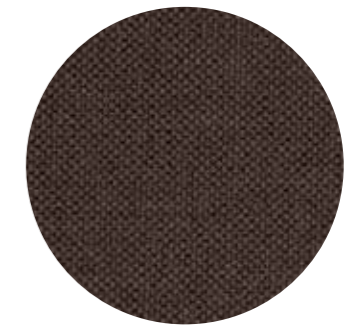

26



16

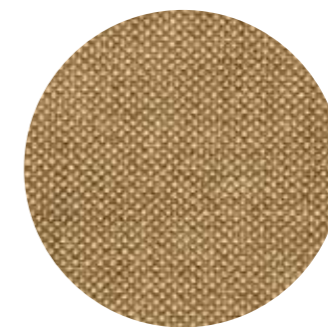

24

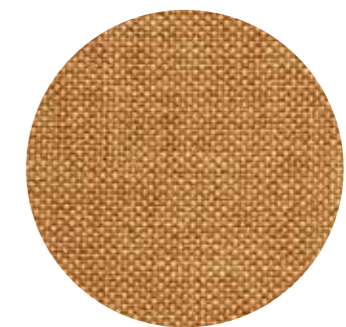

10

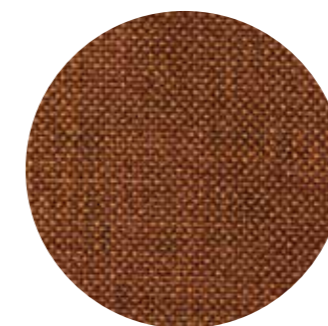

19

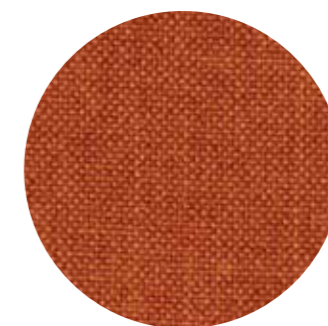

18

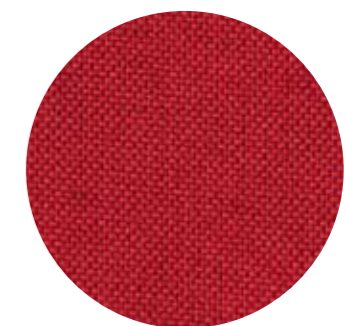

13

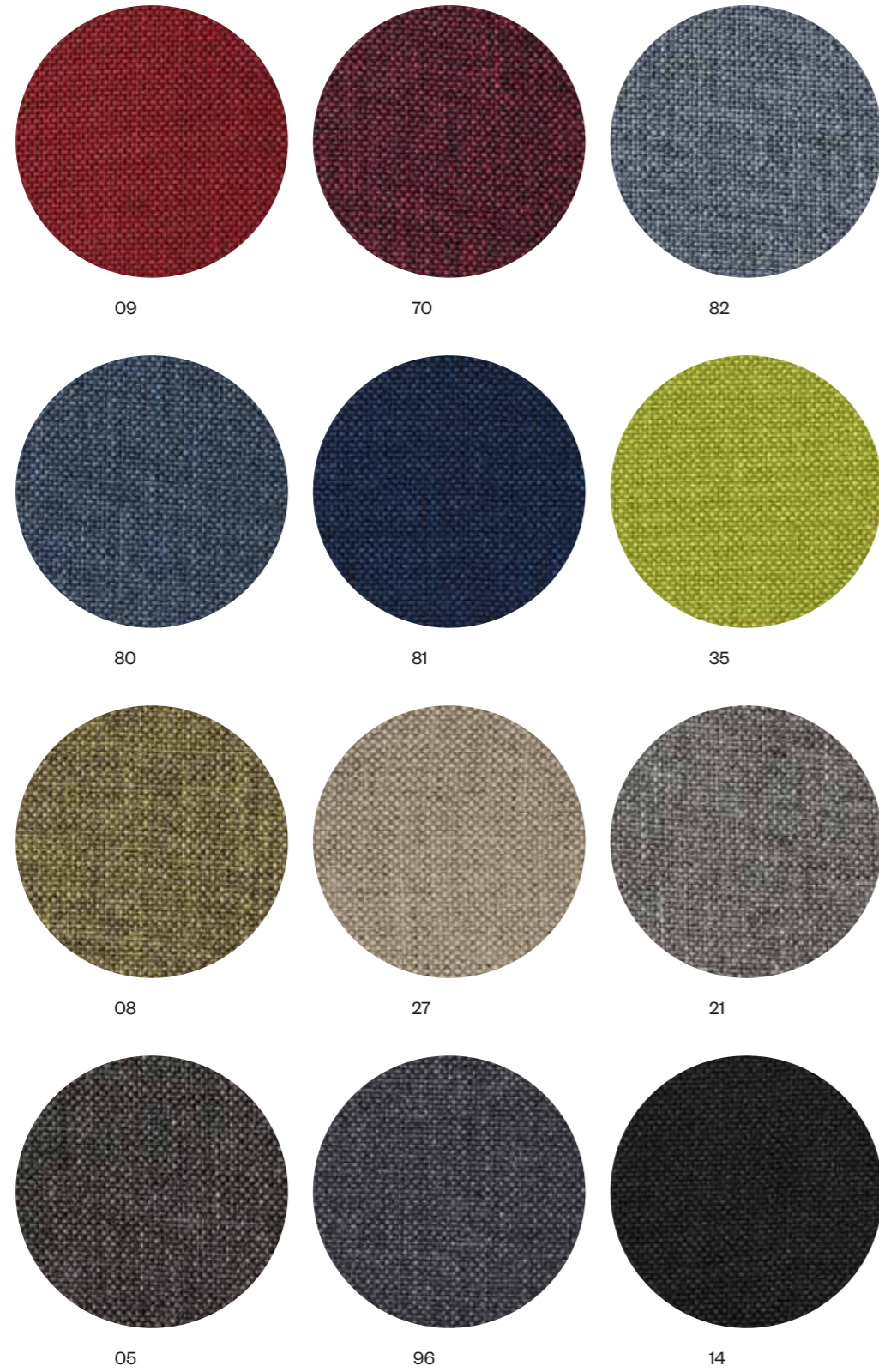

cat. **b**



citadel
camira

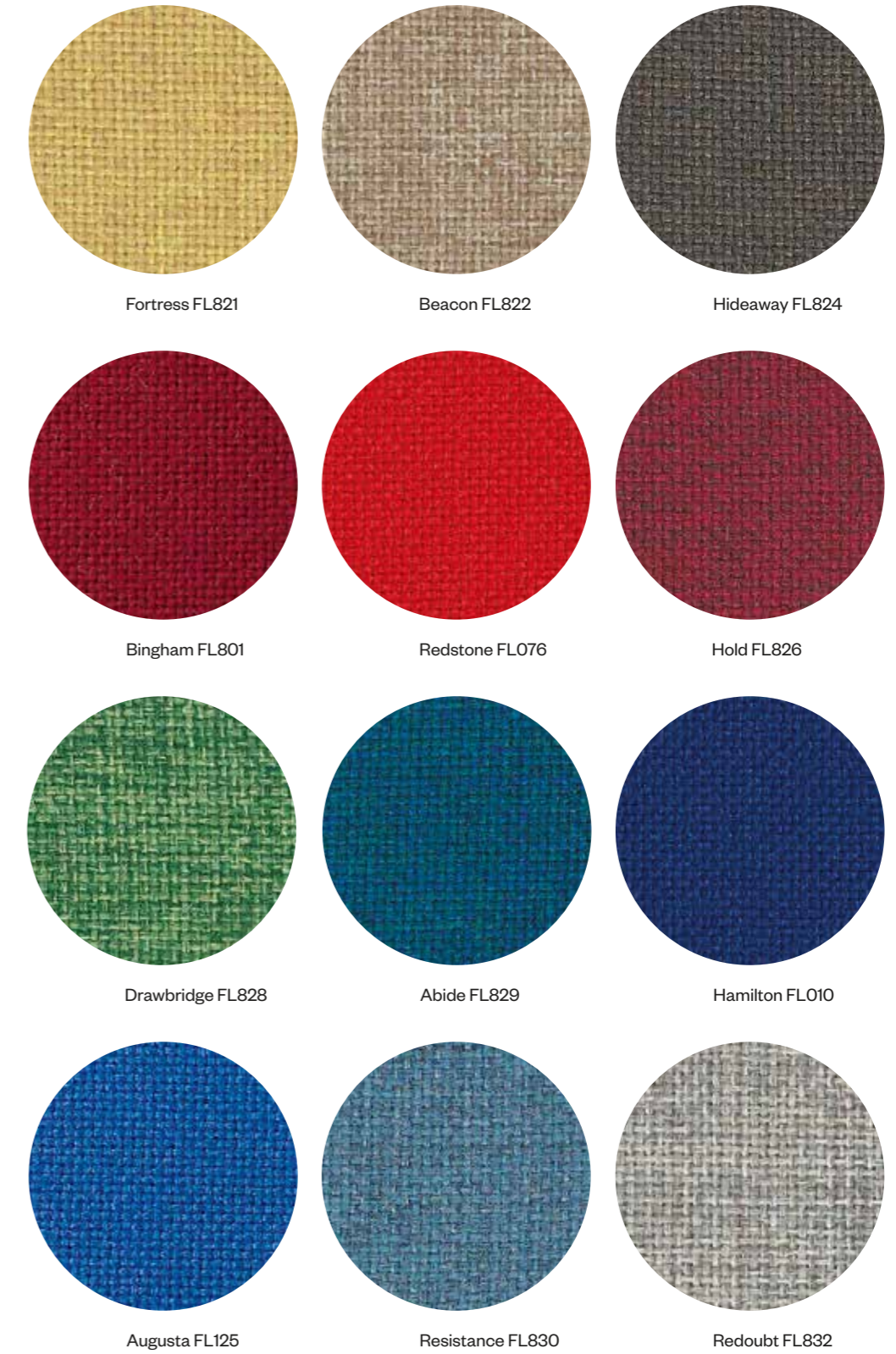

→



Craven FL019

cat. **b**

→

medley
gabriel

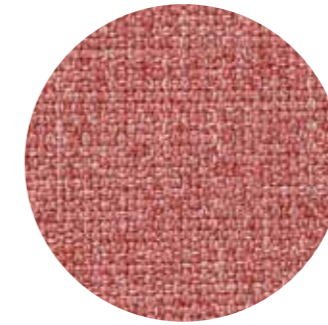

63064

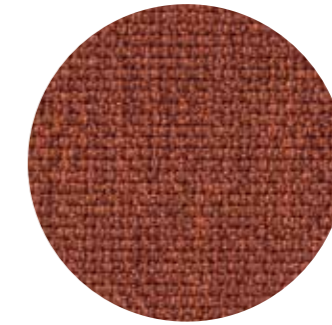

63063



63017



64123

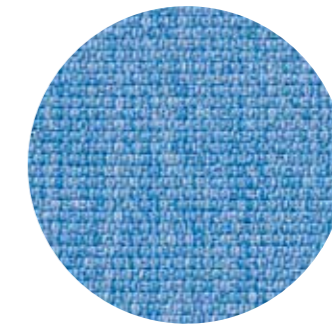

67052



66010

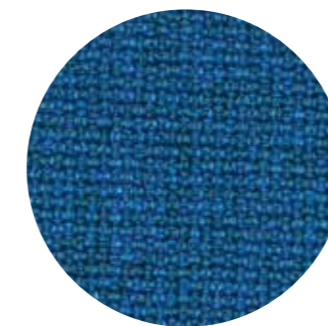

66007



60003



60004

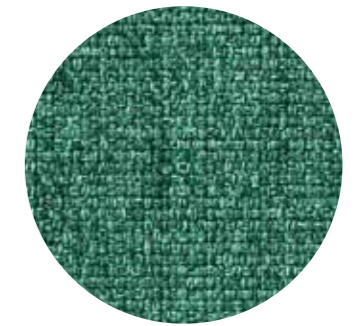

67054

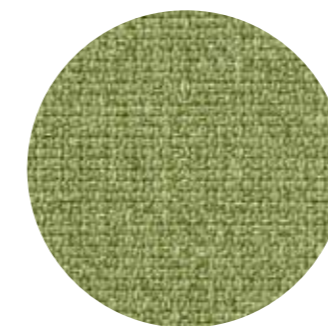

68114

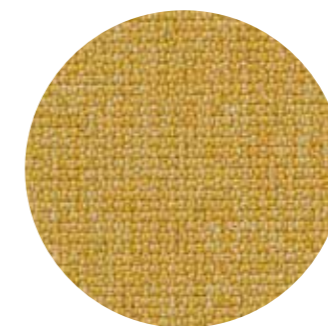

62054



61004



61002

cat. **b**



inca
abitex



01



03

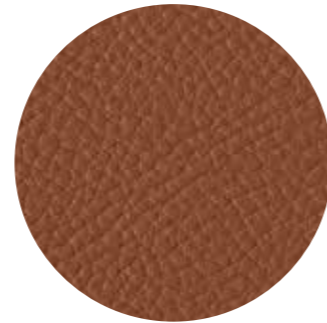

415



11



603

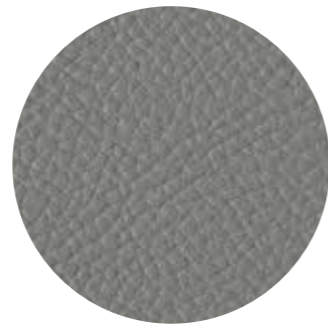

31

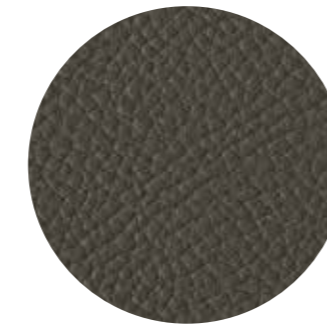

33



42



25

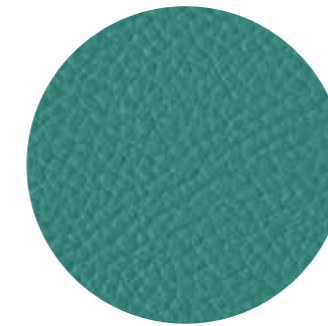

50

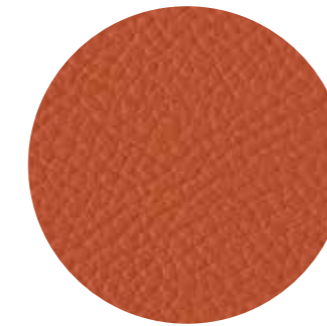

15

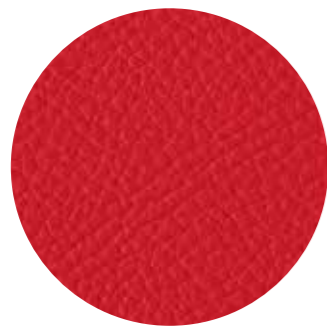

80

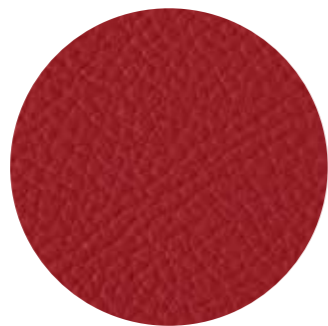

17

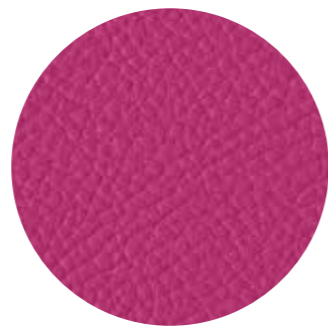

900

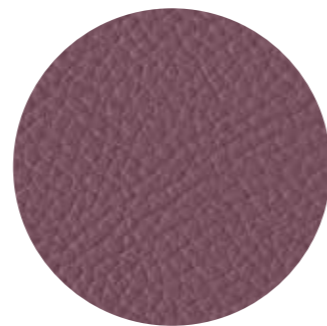

21

cat. **e**

go-couture
gabriel

Non utilizzabile per Uni imbottita, Nassau 533N e Nassau 534N / Not suitable for upholstered Uni, Nassau 533N and Nassau 534N / Pas disponible dans la version rembourrée des modèles Uni, Nassau 533N et Nassau 534N / Nicht benutzbar für die gepolsterten Uni, Nassau 533N und Nassau 534N / No utilizable para Uni tapizadas, Nassau 533N y Nassau 534N

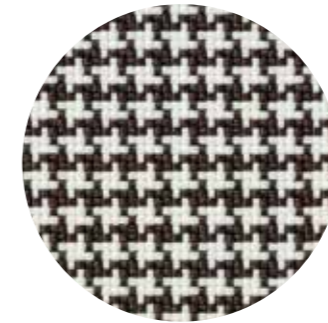

60079



61138

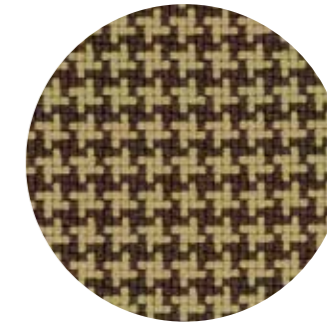

61142

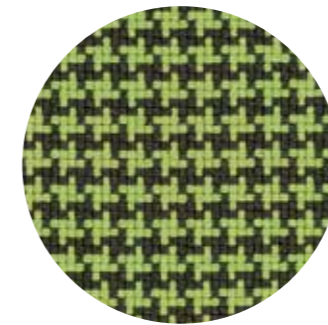

68153

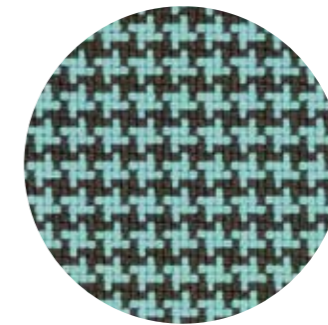

68168

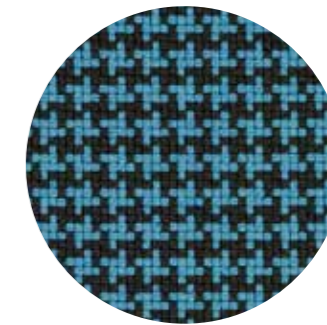

67070

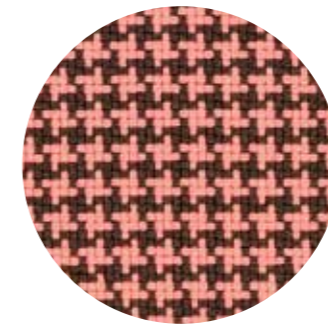

64183

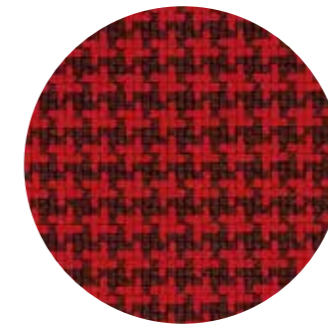

64171



go-check
gabriel

Non utilizzabile per Uni e Uni-Ka imbottite, Nassau 533N e Nassau 534N / Not suitable for upholstered Uni and Uni-Ka, Nassau 533N and Nassau 534N / Pas disponible dans la version rembourrée des modèles Uni et Uni-Ka, Nassau 533N et Nassau 534N / Nicht benutzbar für die gepolsterten Uni und Uni-Ka, Nassau 533N und Nassau 534N / No utilizable para Uni y Uni-Ka tapizadas, Nassau 533N y Nassau 534N

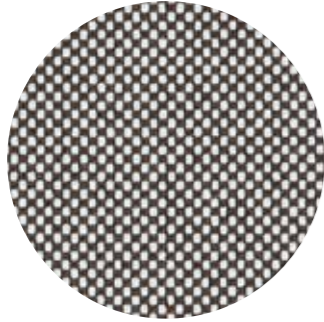

60079

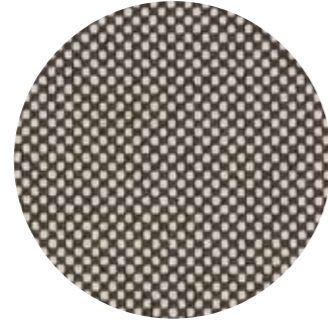

61138



61143



63080

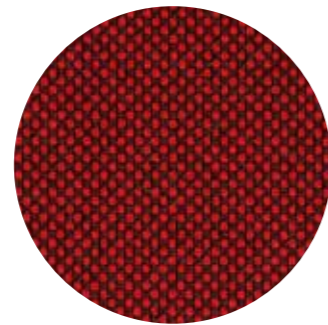

64171



64175

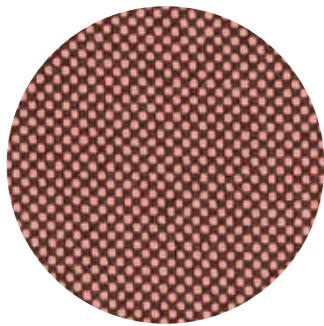

64183

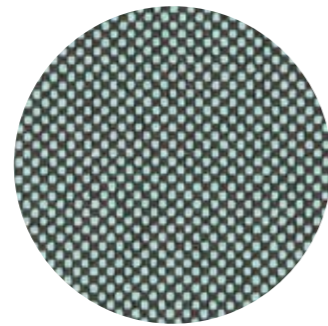

68168

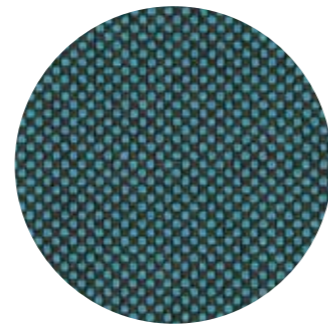

67070

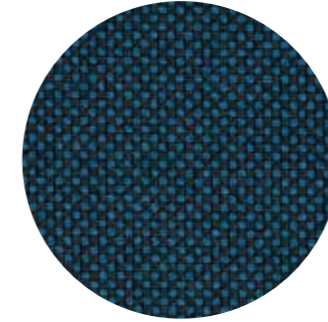

66139

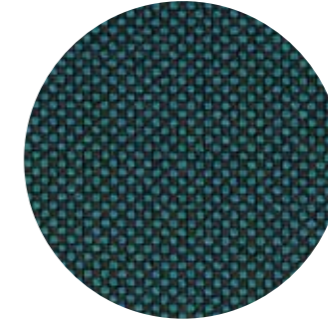

67071

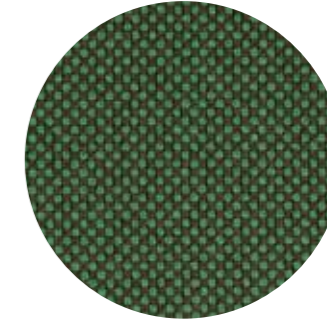

68169

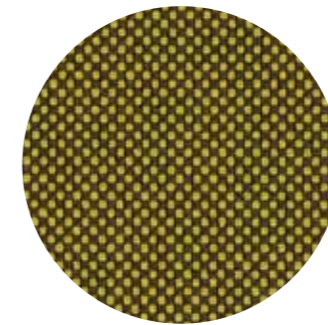

62071

cat. e

crazy
flukso



1001



1002

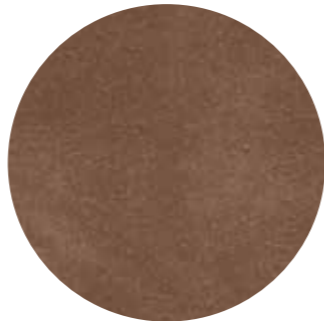

1003

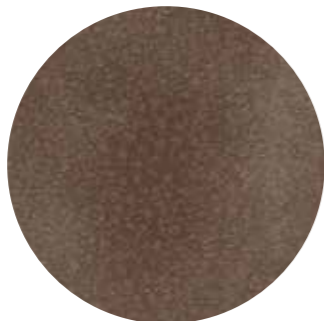

1004

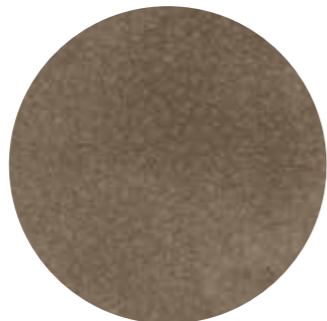

1005

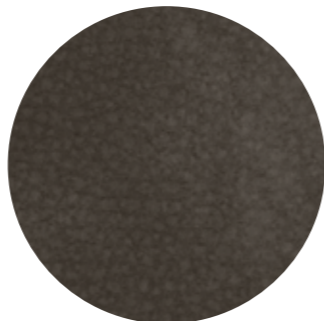

1006

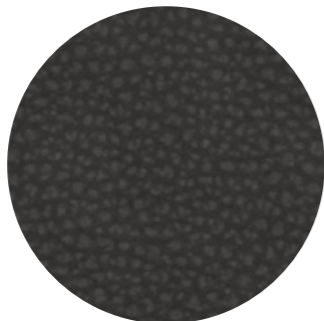

1007

cat. e

solids &
stripes
sunbrella

Solo Playa e Zero /
Only Playa and Zero /
Seulement Playa et
Zero / Nur Playa und
Zero / Solamente
Playa y Zero



3778



48009/00



3127



5436



3756

cat. e

rivet
camira



Molten EGL09

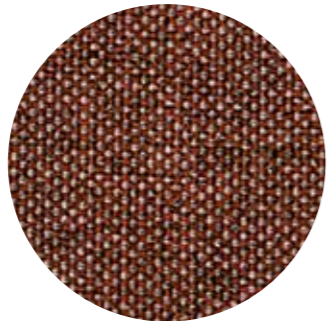

Forge EGL12

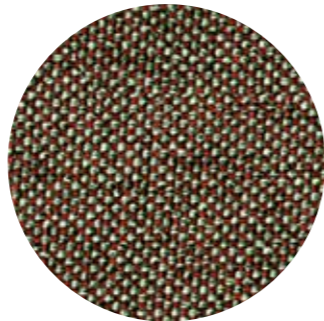

Abrid EGL13

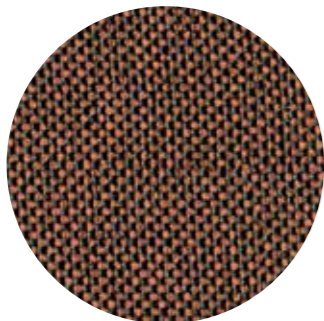

Deep Clay EGL32

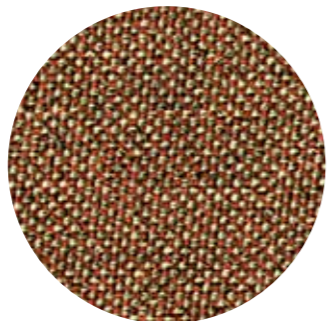

Copper EGL14

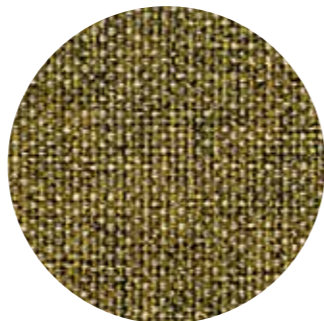

Spark EGL10

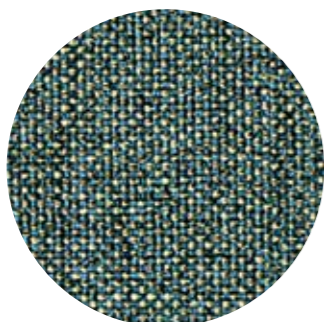

Verdigris EGL21

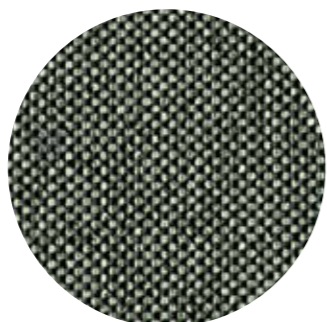

Hemlock EGL34

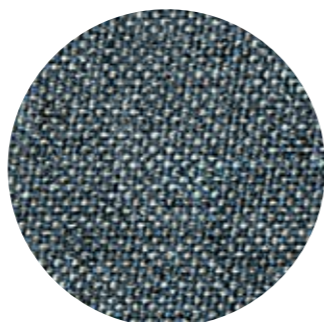

Quench EGL23

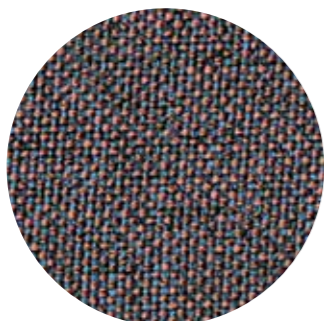

Fuse EGL08



Twig EGL49

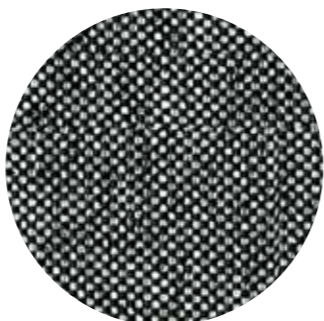

Grey Brindle EGL50

cat. e



valencia
spradling



107-8032



107-1049



107-0034



107-0002



107-0035

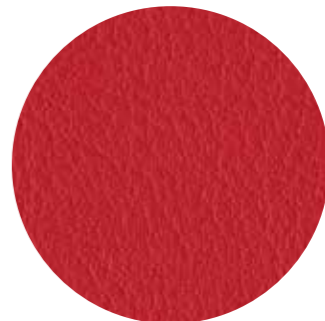

107-2075



107-2074

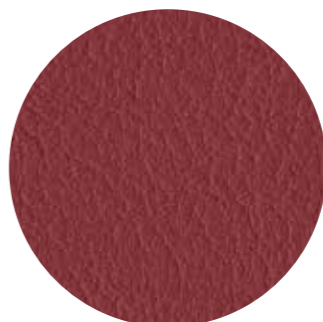

107-2062



107-0020



107-4045



107-4003



107-9035

→

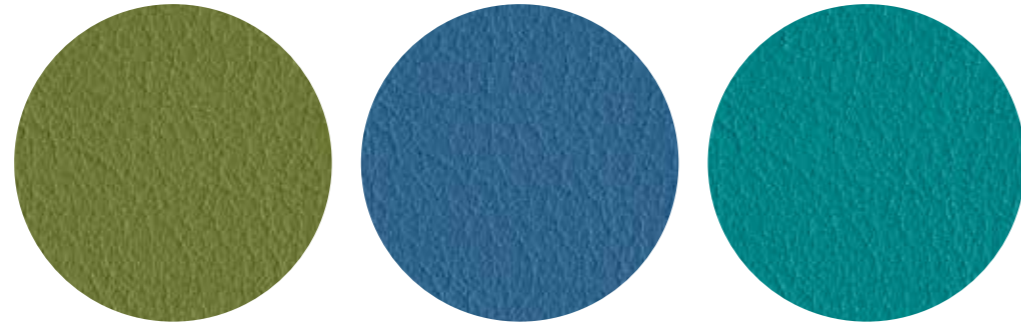

107-5001

107-3069

107-5057



107-6012

107-6019

cat. **g**

→

criss cross
gabriel

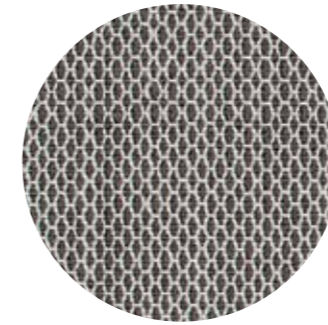

1101

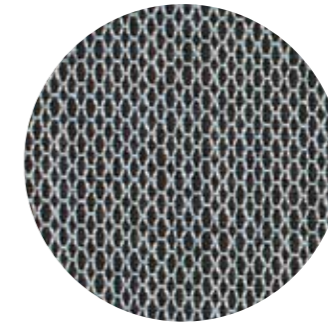

1201



1401

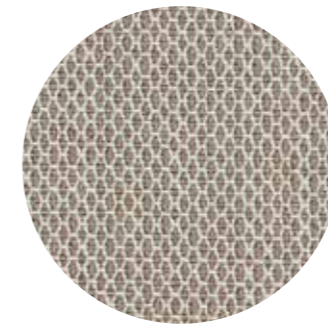

1501

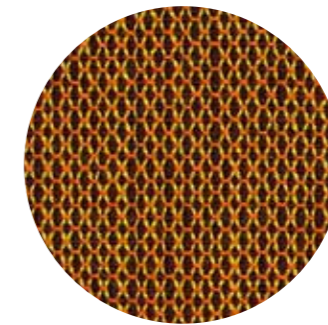

1901

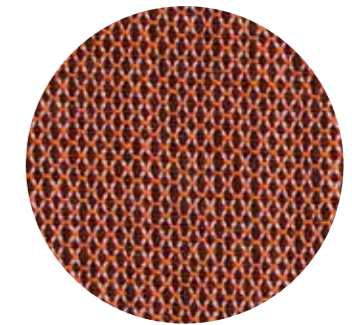

2201

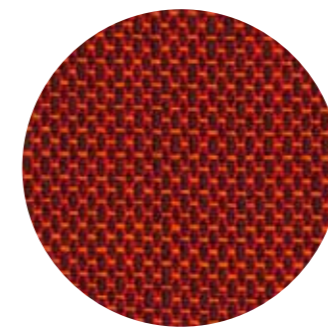

2001

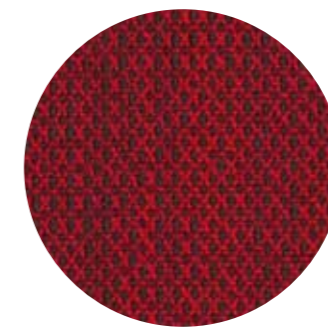

2002

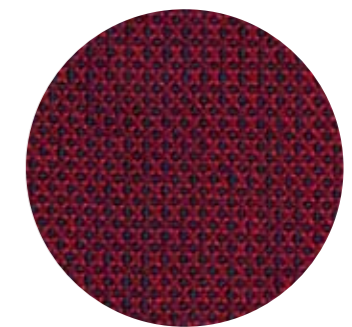

2101

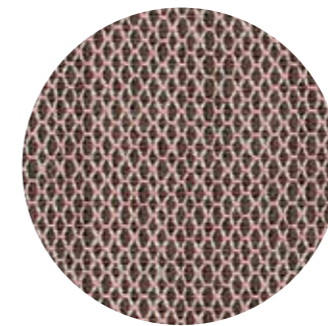

1103

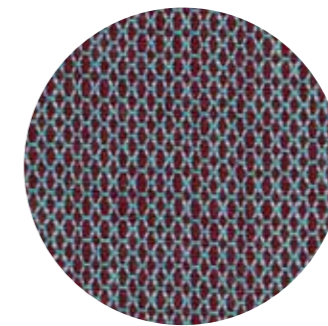

2301

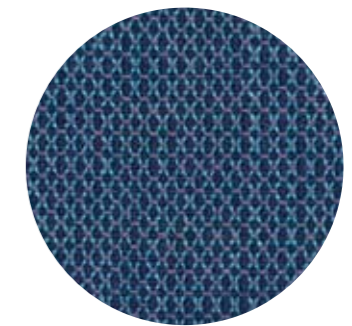

2401

→

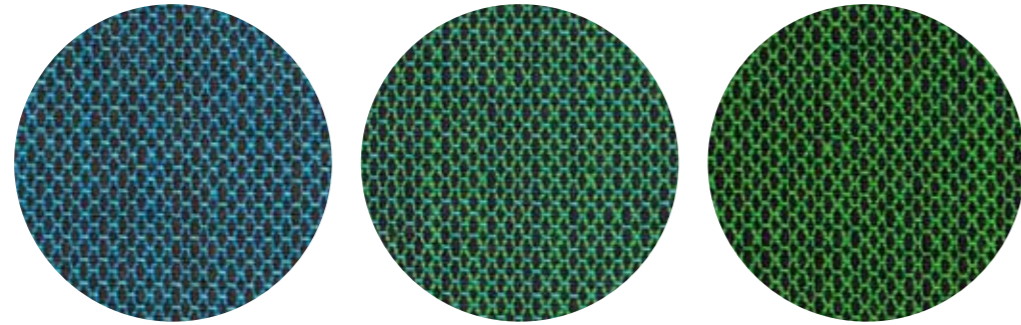

2501

2601

2602

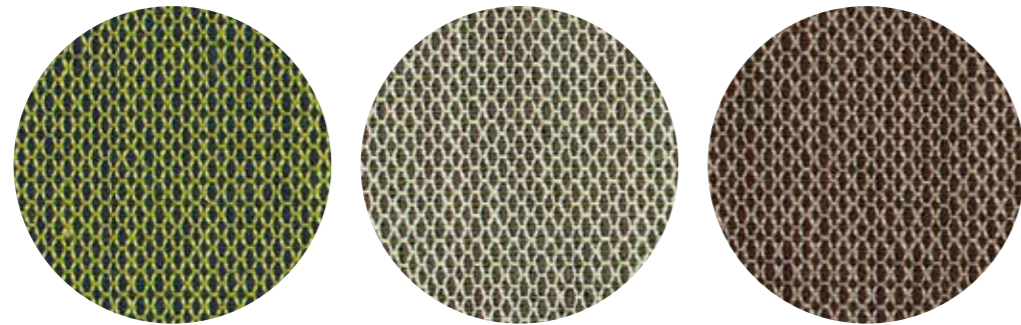

2701

1102

1601

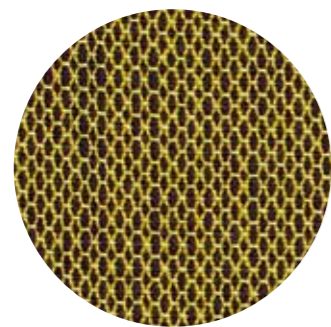

1902

cat. **g**

→

europost 2
gabriel

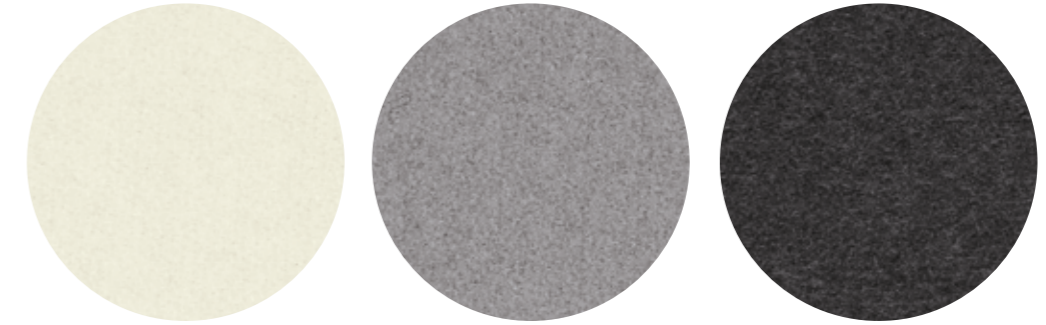

60000

60003

60058



61005

61004

63070



64070

64009

66116

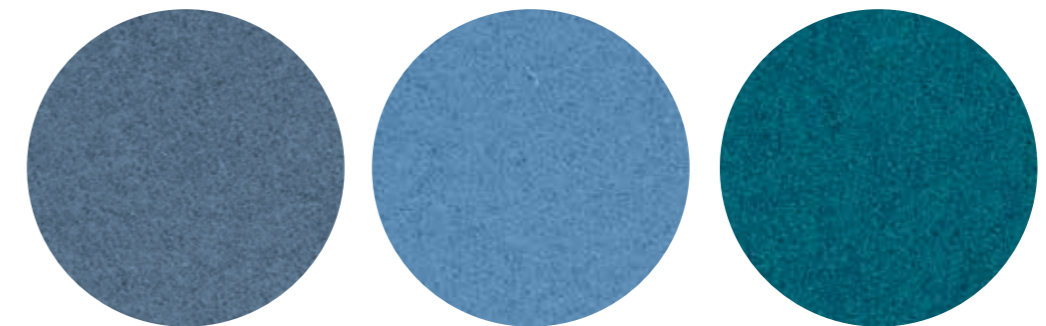

66119

66118

67016

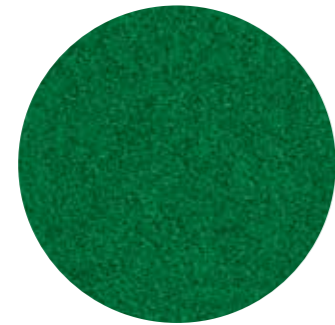

68030



68035

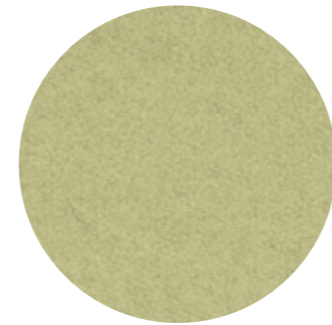

68127

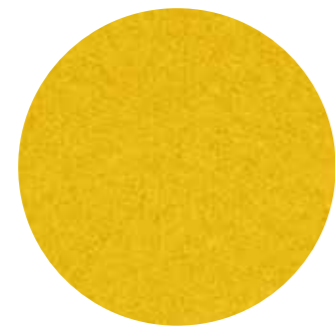

62061

cat. **g**



fame
gabriel

Non utilizzabile per Nassau 533N e Nassau 534N / Not suitable for Nassau 533N and Nassau 534N / Pas disponible dans la version rembourrée des modèles Nassau 533N et Nassau 534N / Nicht benutzbar für die gepolsterten Nassau 533N und Nassau 534N / No utilizable para Nassau 533N y Nassau 534N



60005

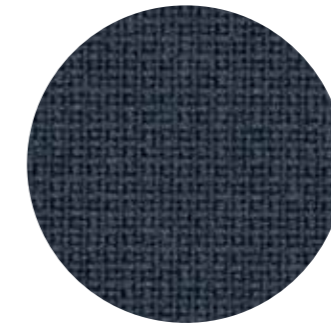

60017

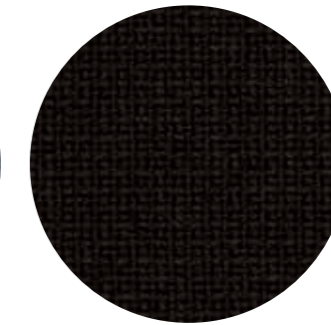

60999



61136

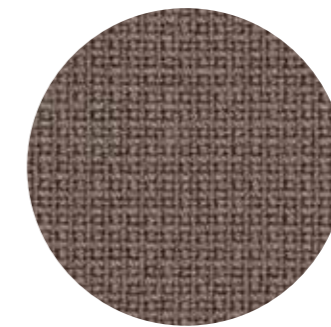

61135

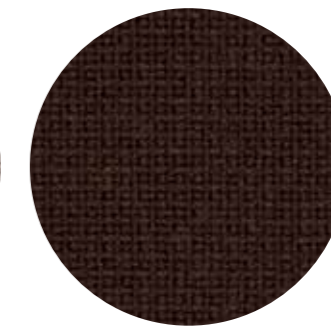

61044

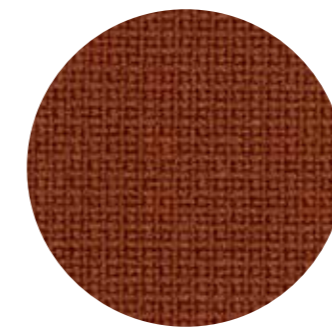

63076

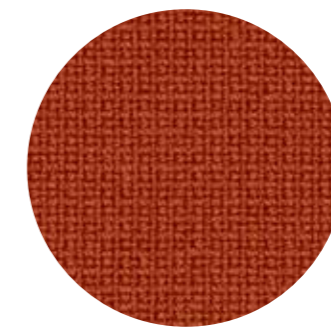

64168

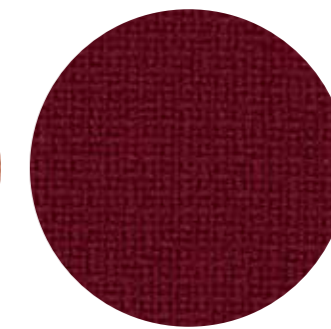

64058

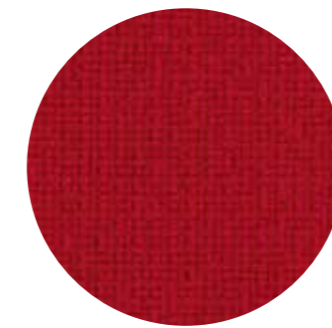

64089

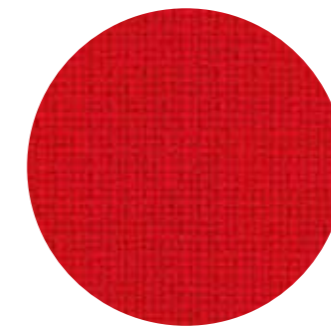

64119



65082

→



64055

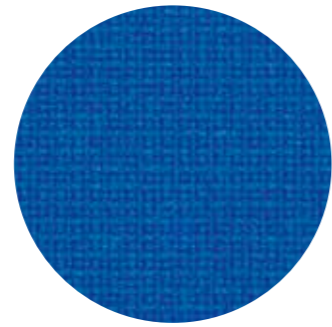

66131



66130

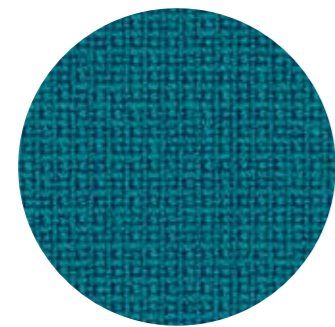

67016

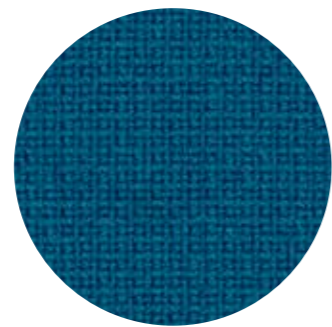

67004



67005

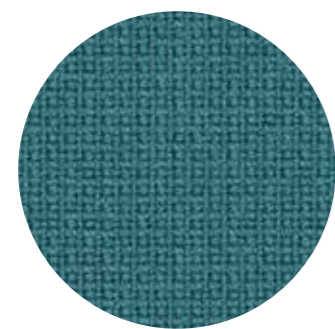

67067

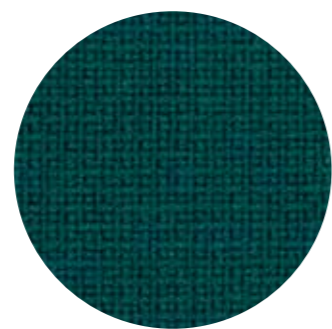

68143



68035



68145



62068

cat. g

bubble
flukso



02

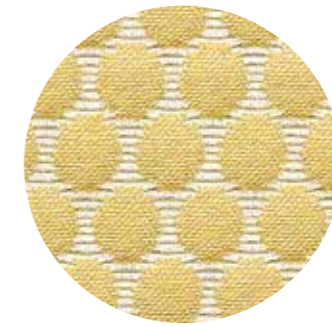

06

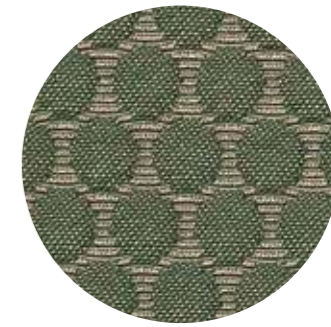

07

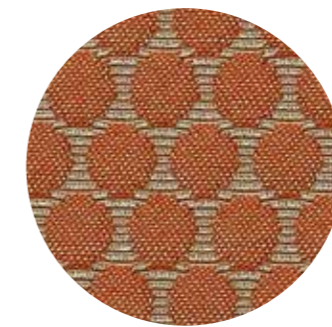

03

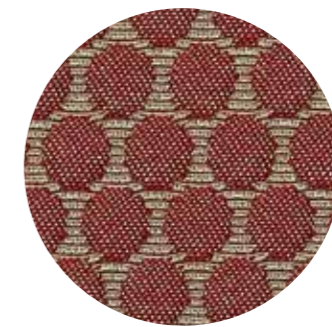

10

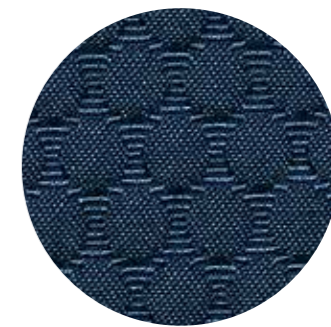

11

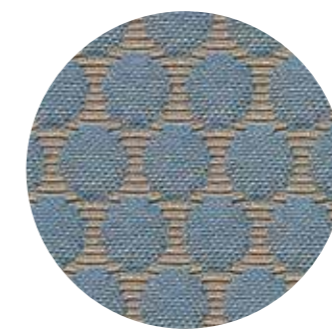

08

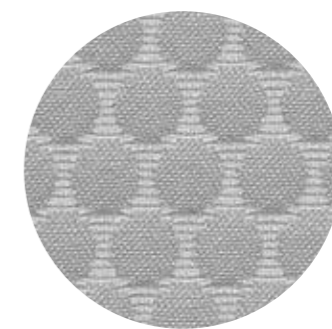

01

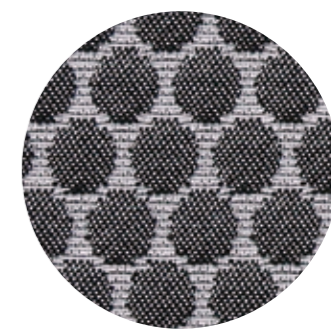

12

cat. g

parotega NF
skai
hornschnuch



1652



1632



1661



1658



1656



1665



1654



1659

cat. g

balta
vescom

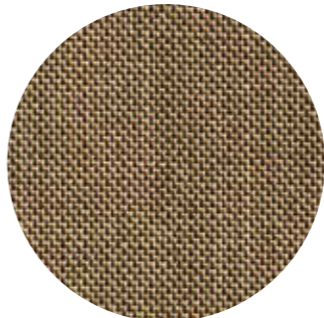

7040.02

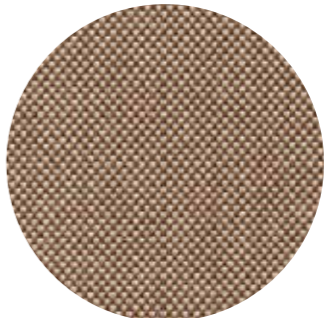

7040.08



7040.09

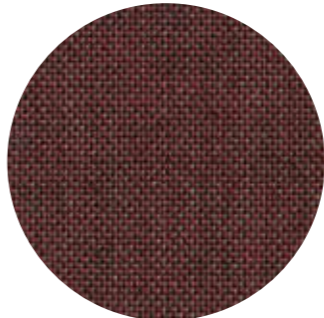

7040.10

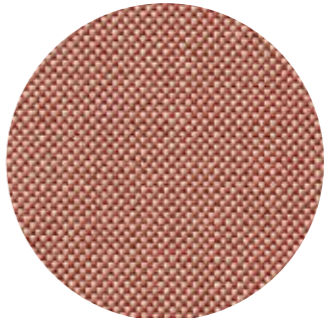

7040.07

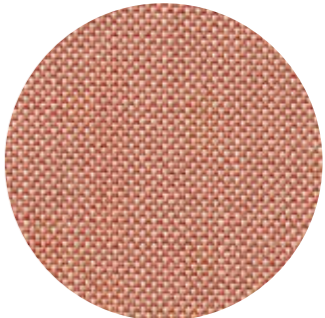

7040.04

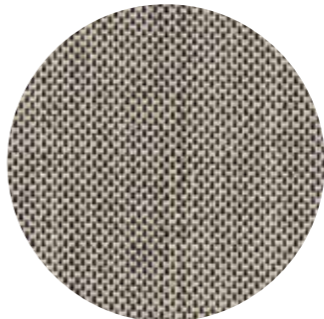

7040.03

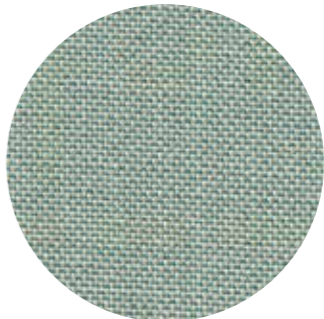

7040.11

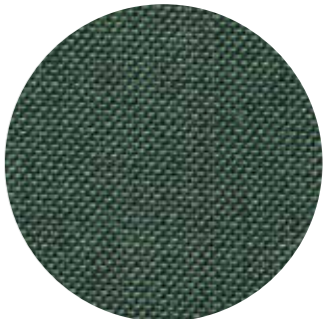

7040.12



7040.13

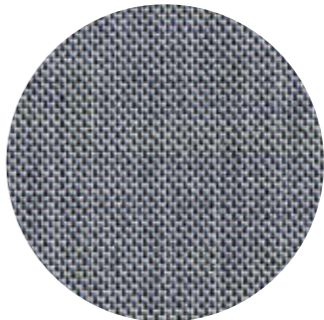

7040.17

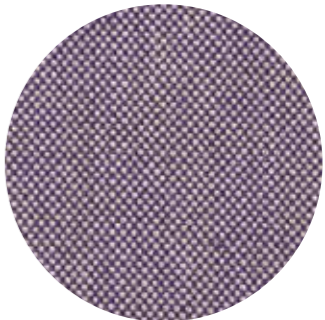

7040.18

main line
flax
camira

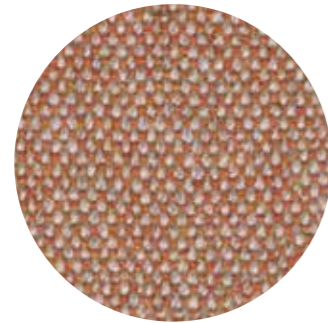

Lambeth MLF08

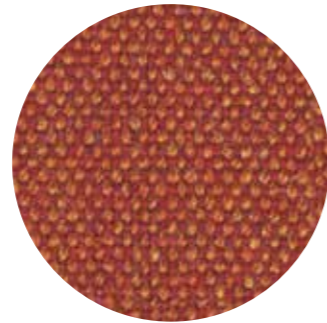

Leyton MLF13



Parsons MLF14

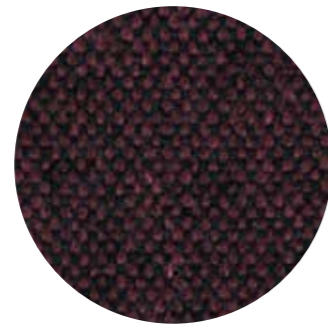

Northfields MLF40



Hillingdon MLF41

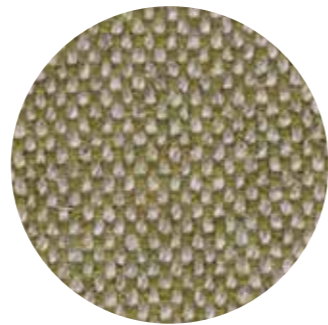

Kensington MLF07

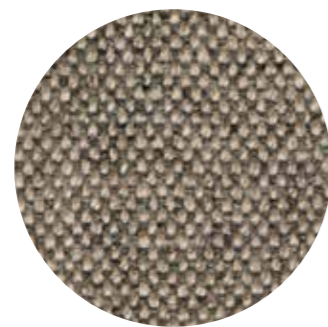

Archway MLF02



Bank MLF23

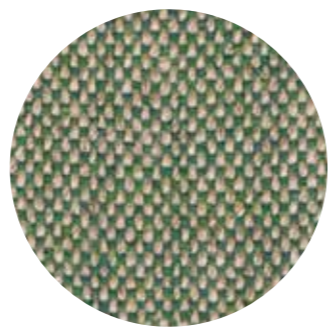

Monument MLF09



Temple MLF16

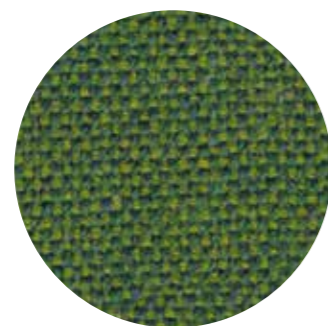

Tufnell MLF18

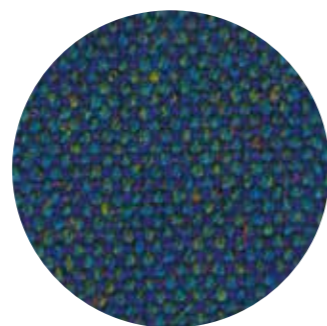

Pimlico MLF34

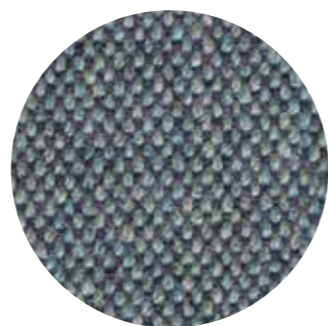

Westminster MLF22



superb
trevira
flukso

Non utilizzabile per
Uni, Uni-Ka e Nassau
imbottite / Not suitable
for upholstered Uni,
Uni-Ka and Nassau / Pas
disponible dans la version
rembourrée des modèles
Uni, Uni-Ka et Nassau /
Nicht benutzbar für die
gepolsterten Uni, Uni-Ka
und Nassau / No utilizable
para Uni, Uni-Ka y Nassau
tapizadas



5103

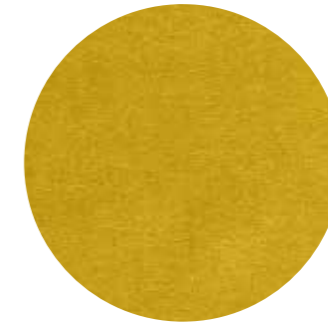

5106

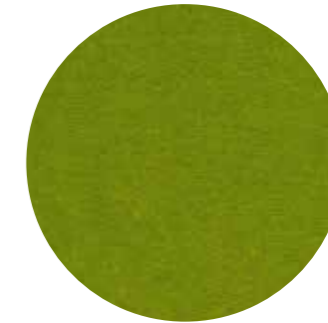

5139

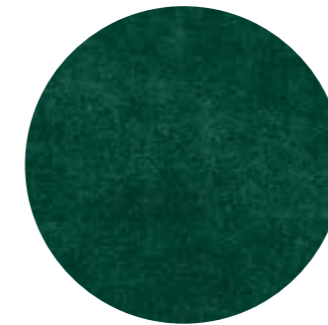

5135



5140

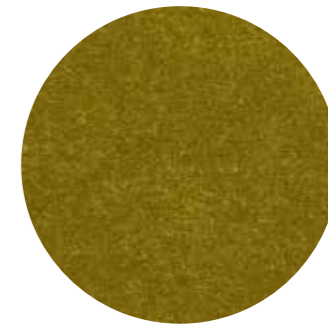

5141

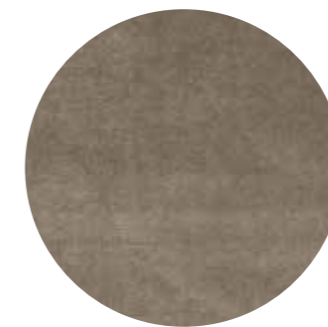

5149

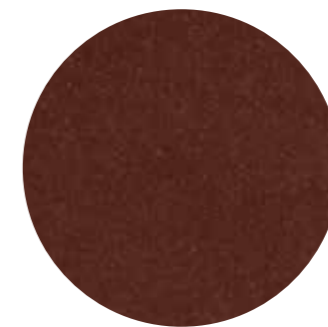

5145

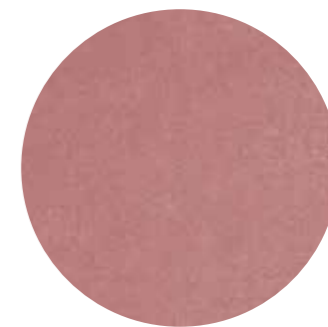

5114

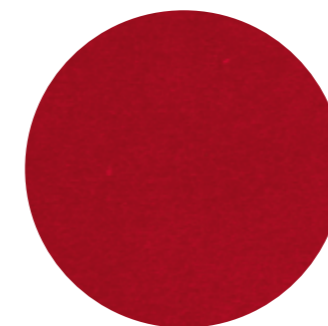

5116

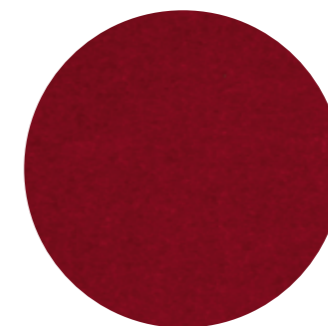

5118

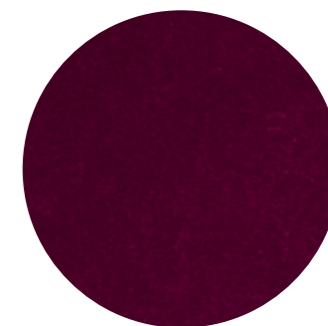

5123



5131

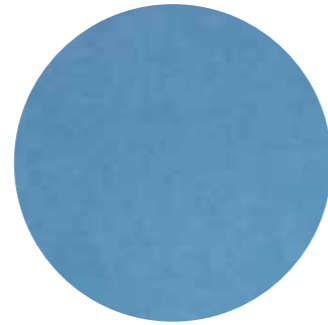

5130



5127



5147



5152

cat. l



remix 2
kvadrat

Non utilizzabile per
Uni, Uni-Ka imbottite
e per Nassau 533M /
Not suitable for
upholstered Uni, Uni-Ka
and Nassau 533M /
Pas disponible dans
le version rembourrée
des modèles Uni,
Uni-Ka et Nassau 533M /
Nicht benutzbar für
die gepolsterten Uni,
Uni-Ka und Nassau /
No utilizable para
Uni y Uni-Ka tapizadas
y Nassau 533M

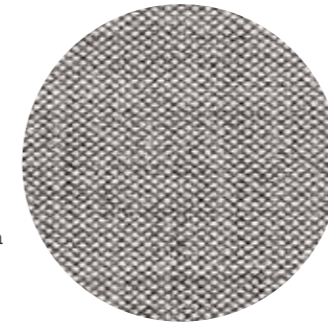

123



223

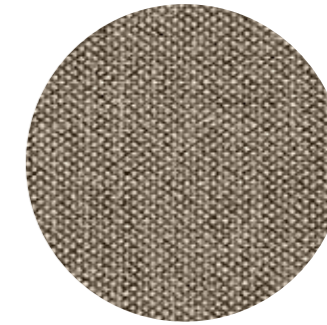

233

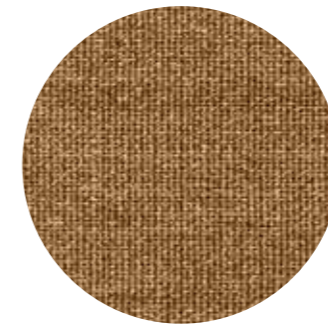

433

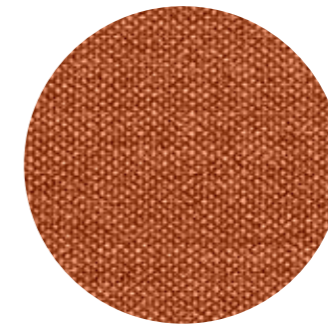

443

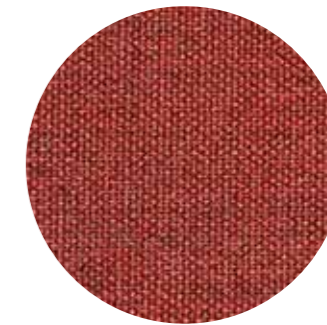

653

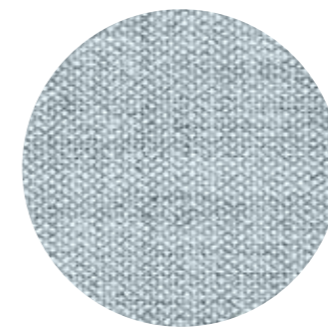

823

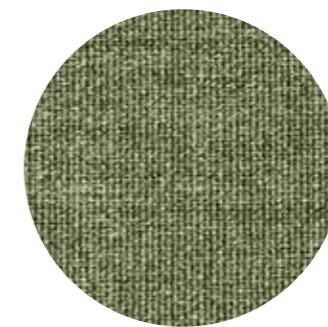

933

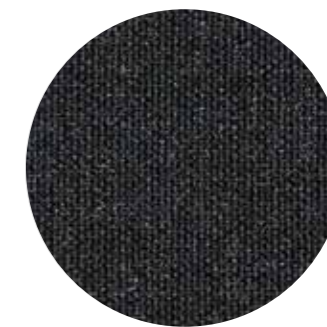

183

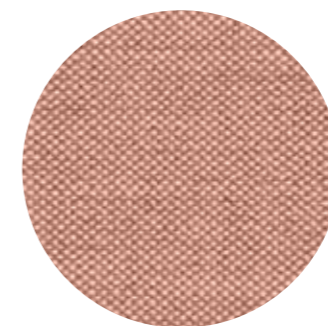

612

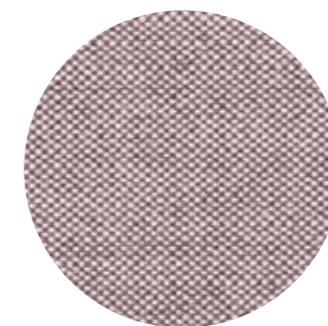

682

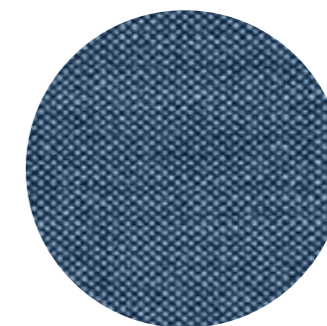

762

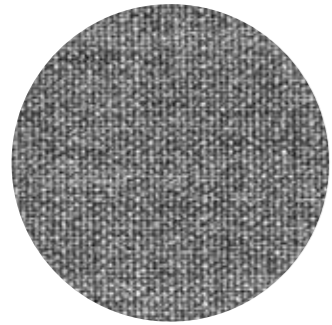

143

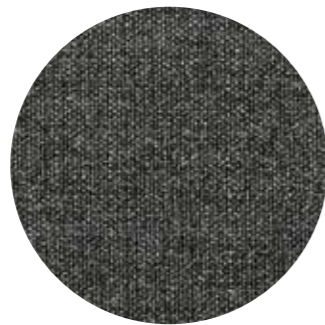

163



662

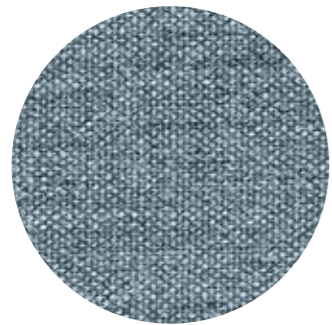

733

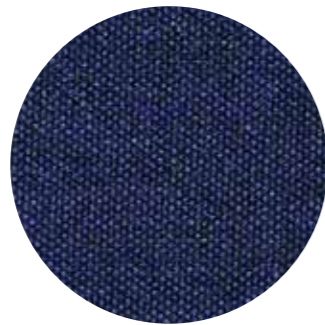

773

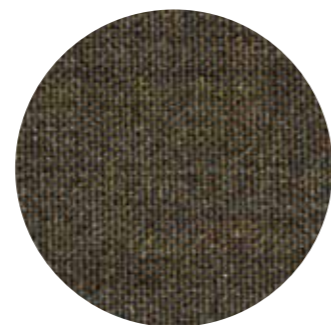

954

cat. l

revive 2 kvadrat

Non utilizzabile per
Uni, Uni-Ka imbottite
e per Nassau 533M /
Not suitable for
upholstered Uni, Uni-Ka
and Nassau 533M /
Pas disponible dans
le version rembourrée
des modèles Uni,
Uni-Ka et Nassau 533M /
Nicht benutzbar für
die gepolsterten Uni,
Uni-Ka und
Nassau 533M /
No utilizable para
Uni y Uni-Ka tapizadas
y Nassau 533M

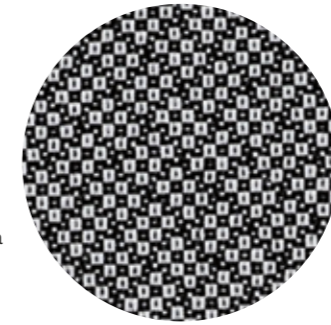

153

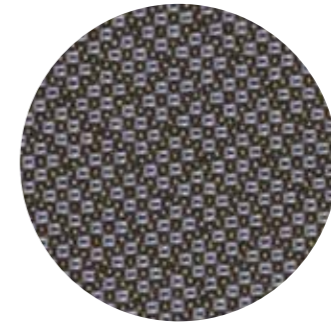

173



323



453

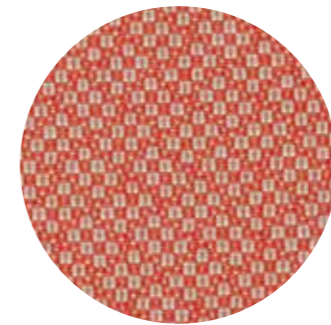

523

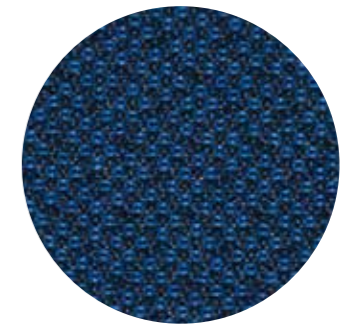

773

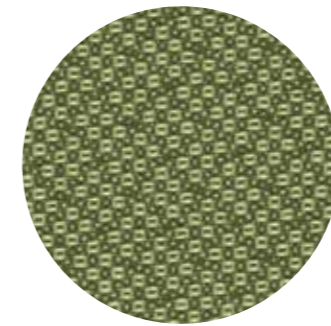

933



steelcut
trio 3
kvadrat

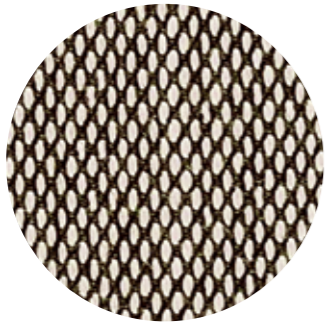

124



133

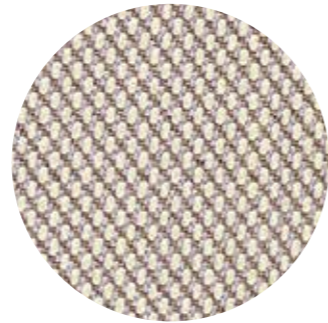

205



515



645

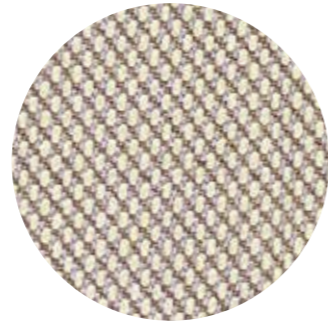

213



253



276

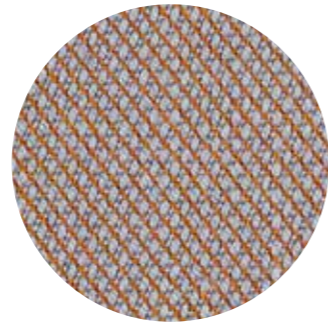

426

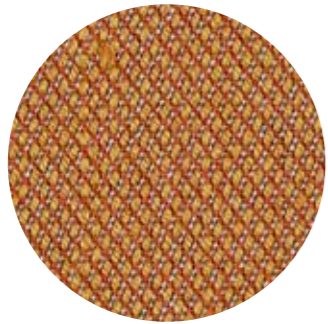

436



453



576

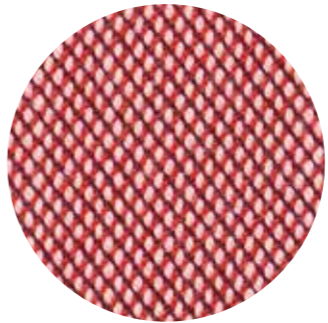

636



666

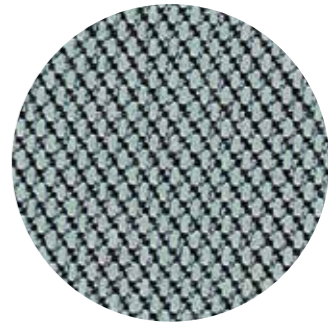

713

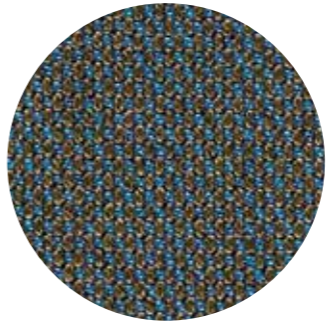

883

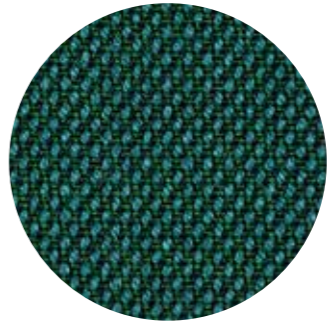

976

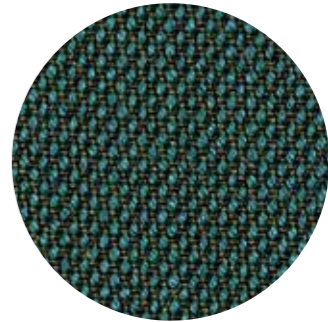

996



416



776

cuoio / leather / cuir / leder / cuero

CU

solo / only / seulement/
nur / solamente
Flint 535-A



Nero / Black / Noir /
Schwarz / Negro

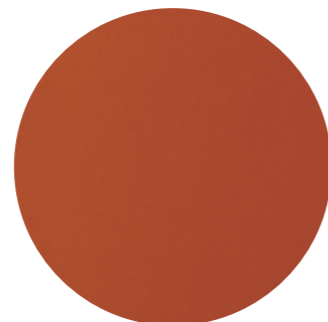

Mattone / Brick red /
Rouge brique /
Ziegelrot / Ladrillo



Testa di moro / Dark
brown / Marron foncé /
Dunkelbraun / Marrón
oscuro

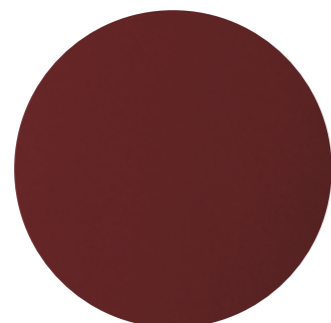

Bordeaux / Bordeaux /
Bordeaux / Bordeaux /
Bordeaux

tessuti: note tecniche / fabrics: technical notes / tissus: notes techniques / stoffe: technische hinweise / tejidos: notas técnicas

1 Determinati coloranti di vestiti o di accessori (es. jeans denim) possono migrare verso i colori più chiari. Questo fenomeno è incrementato dall'umidità e dalla temperatura ed è irreversibile. Et al. non si assume nessuna responsabilità per il trasferimento di colorante causato da contaminante esterno e per le possibili macchie permanenti causate da questo fenomeno.
2 Sono ammesse leggere variazioni di colore tra differenti lotti di produzione dei tessuti.
3 I colori dei tessuti possono variare rispetto ai riferimenti cromatici forniti nel presente documento a causa delle inevitabili differenze tra i materiali reali e la riproduzione tipografica. Per ulteriori informazioni si prega di contattare l'ufficio commerciale prima dell'ordine.

1 Certain clothing or accessories dyes (such as those used on denim jeans) may migrate to lighter colors. This phenomenon is increased by humidity and temperature and is irreversible. Et al. will not assume responsibility for dye transfer caused by external contaminants and the possible permanent staining caused by this phenomenon.
2 Slight color differences may occur between different production batches.
3 Fabric colors may vary from the color references provided in this document due to the inevitable differences between real materials and typographical reproduction. For more information please contact the sales office.

1 Les pigments / teintures de certains vêtements et accessoires (telles que celles utilisés pour le jeans) peuvent déteindre sur des surfaces plus claires. Ce phénomène s'accroît avec l'humidité, la température et est irréversible. Et al. n'assume aucune garantie ni responsabilité, ni pour le dépôt de ces pigments/teintures ni pour l'encrassement permanent causé par ces vêtements / substances.
2 De légères différences de couleurs peuvent se produire entre différents lots de production.
3 Les couleurs des tissus peuvent varier comparés à les références de couleur fournies dans ce document en raison des différences inévitables entre les matériaux réels et la reproduction typographique. Pour plus d'informations, avant la commande veuillez contacter le bureau de vente.

1 Die Farbstoffe bestimmter Textilien und Accessoires (z.B. Jeans) können auf hellere Oberflächen abfärben. Dieser Effekt nimmt mit steigender Feuchtigkeit und Temperatur zu und ist irreversibel. Et al. haften weder für das Abfärben durch externe Stoffe oder verunreinigende Substanzen, noch für eine eventuell dadurch entstehende permanente Verschmutzung / Verfärbung.
2 Geringfügige Abänderung in Farbe sind, zwischen verschiedenen Produktionschargen von Stoffen, erlaubt.
3 Die Farben der Stoffe können von Farbe Referenzen hier wegen der unvermeidlichen Unterschiede zwischen realen Materialien und die typografische Reproduktion zur Verfügung gestellten abweichen. Für weitere Fragen, kontaktieren Sie unsere Verkaufsabteilung bitte, bevor der Bestellung.

1 Ciertas prendas de vestir y tintes de accesorios (como los utilizados en los pantalones vaqueros) pueden migrar a superficies más claras. Este fenómeno se ve incrementado por los efectos de la humedad y la temperatura y es irreversible. Et al. no asumirá ninguna responsabilidad ante reclamos de transferencia de color originados por contaminantes externos ni ante reclamos de manchas permanentes causadas por este fenómeno.
2 Están admitidas ligeras variaciones de color entre partidas de producción distintas.
3 Los colores de los tejidos pueden variar con referencia a los presentes en este documento a causa de la diferencia entre el material mismo y su reproducción tipográfica. Para más informaciones favor de contactar la oficina antes de pasar pedidos.

tessuti: composizione e prove / fabrics: composition and tests / tissus: composition et tests / stoffe: zusammensetzung und test / tejidos: composición y pruebas

cat a	
	
sawana davis	
composizione / composition / composition / Zusammensetzung / composición: 100% PL	
<p>prove / tests / tests / Test / pruebas: Abrasion resistance EN ISO 12947-1,2: 100.000 Martindale Pilling EN ISO 12945-2: 4/5 Colour fastness to light ISO 105-B02: grey scale, 4</p> <p>Colour fastness to rubbing ISO 105-X12: dry 4/5, wet 4/5</p> <p>Fire resistance: BS 5852: Part 1: 1979 ignition source 1 (match) / 0 cigarette, EN 1021-1 ignition source 1 cigarette</p> <p>Tensile strength ISO 13934-1: warp 1248 N, weft 1324 N</p> <p>Tear growth resistance ISO 13937-2: 86,3 N/86,7 N</p> <p>Resistance to seam slippage EN ISO 13936-2: 2,8 mm/3,1 mm</p>	

cat b

citadel camira
composizione / composition / composition / Zusammensetzung / composición: 100% PP
<p>prove / tests / tests / Test / pruebas: Abrasion resistance: >30.000 Martindale</p> <p>Colour fastness to light UNI EN ISO 105-B02: 6</p> <p>Colour fastness to rubbing ISO 105-X12: dry 4, wet 4</p> <p>Fire resistance: EN 1021 Part 1&2, BS 7176 Low Hazard, DIN 4102 B1, ONORM B 3825 & A 3800</p>

medley gabriel
composizione / composition / composition / Zusammensetzung / composición: 100% PL
<p>prove / tests / tests / Test / pruebas: Abrasion resistance rubs EN ISO 12947-2: 75.000 Martindale; double rubs Wizenbeek ASTM D4157-02 (Heavy Duty Upholstery) 100.000 Pilling EN ISO 12945-2: 4</p> <p>Colour fastness to light EN ISO 105-B02: 5/7</p>

Colour fastness to rubbing EN ISO 105-X12: dry 4/5, wet 4/5

Fire resistance: BS EN 1021 Part 1&2, EN 1021-1 cigarette, BS 5852 0,1 cigarette & match, UNI 9175 Classe 1.IM, ONORM B 3825-B2-3800-Q1 UK, CA TB 117-2013, ASTM E 84.

US ACT: AATCC 16 Light fastness - pass, AATCC 8 or 116 wet/dry crocking- pass, CA TB 117-2013

- pass, ASTM D4157-07 WYZ

Abrasion (Heavy Duty) - pass, ASTM D3511 Pilling - pass

inca abitex
composizione / composition / composition / Zusammensetzung / composición: 88% PVC, 6% PL, 6% CO
<p>prove / tests / tests / Test / pruebas: Abrasion resistance: >100.000 Martindale</p> <p>Tensile resistance UNI EN ISO 1421: long > 300 N/5cm, across > 200 N/5cm</p> <p>Extension at break UNI EN ISO 1421: long > 40%, across > 145%</p> <p>Tear strength UNI 4818-P9: long > 50 N, across > 90 N</p> <p>Adhesion UNI EN ISO 2411: long > 30 N, across > 30 N</p> <p>Colour fastness to rubbing ISO 105-X12: dry 4, wet 4</p> <p>Colour fastness to light UNI ISO 4582 / 4892: blu scale 7</p> <p>Free from: COL., AZO, CD, FCKW, PCB, PCP, PCT, FORMALDEHYDE</p> <p>Fire resistance: UNI 9175 Classe 1.IM, EN 1021 Part 1&2, BS 5852:1979 IS O+1, NF-P92 503 Class M2, California TB 117:2013, FTP Code 307(88): 10 Annex 1 Part 8</p>

go check gabriel
composizione / composition / composition / Zusammensetzung / composición: 100% Trevira CS
<p>prove / tests / tests / Test / pruebas: Abrasion resistance rubs BS EN 14465 - BS EN ISO 12947-2: 80.000 Martindale; double rubs Wizenbeek ASTM D4157-07 (Heavy Duty Upholstery) 60.000 Pilling EN ISO 12945-2: 5</p> <p>Colour fastness to light UNI EN ISO 105-B02: 5/8</p> <p>Colour fastness to rubbing ISO 105-X12: dry 4/5, wet 4/5</p> <p>Fire resistance: EN 1021 Part 1&2, BS 5852 0&1, BS 5852 Crib 5, DIN 4102 B1, UNI 9175 Class 1.IM, FAR/JAR 25.853, ONORM B 3825 B1-Q1, NFP92-502-M1, BS 7176 Medium Hazard, DIN EN 13501-1-B-s1, d0, CA TB 117-2013</p> <p>US ACT: AATCC 16 Light fastness - pass, AATCC 8 or 116 wet/dry crocking- pass, CA TB 117-2013</p> <p>- pass, ASTM D4157-02 WYZ</p> <p>Abrasion (Heavy Duty Upholstery) - pass, ASTM D3511 Pilling - pass</p>
crazy flukso
composizione / composition / composition / Zusammensetzung / composición: 80% PVC, 2% PU, 18% PL
<p>prove / tests / tests / Test / pruebas: Abrasion resistance EN ISO 5470-2: 50.000 Martindale</p> <p>Colour fastness to rubbing UNI EN ISO 105-X12: dry 4/5, wet 4/5</p> <p>Adhesion UNI EN ISO 2411: 35 N</p> <p>Bending strength UNI 4818-13: 150.000 cycles</p> <p>Tensile strength UNI EN ISO 1421: long 515 N, trasv. 300 N</p> <p>Fire resistance: UNI 9175 Classe 1.IM, EN 1021:2</p>

cat e

go couture gabriel
composizione / composition / composition / Zusammensetzung / composición: 100% Trevira CS
<p>prove / tests / tests / Test / pruebas: Abrasion resistance rubs BS EN 14465 - BS EN ISO 12947-2: 80.000 Martindale</p> <p>Pilling EN ISO 12945-2: 5</p> <p>Colour fastness to light UNI EN ISO 105-B02: 5/8</p> <p>Colour fastness to rubbing ISO 10- X12: dry 4/5, wet 4/5.</p> <p>Fire resistance: EN 1021 Part 1&2,</p>

prove / tests / tests / Test / pruebas: Abrasion resistance rubs BS EN 14465 - BS EN ISO 12947-2: 80.000 Martindale
Pilling EN ISO 12945-2: 5
Colour fastness to light UNI EN ISO 105-B02: 5/8
Colour fastness to rubbing ISO 10- X12: dry 4/5, wet 4/5.
Fire resistance: EN 1021 Part 1&2,

BS 5852 0&1, BS 5852 Crib 5, DIN 4102 B1, UNI 9175 Class 1.IM, FAR/JAR 25.853, ONORM B 3825 B1-Q1, NFP92-502-M1, BS 7176 Medium Hazard, DIN EN 13501-1-B-s1, d0, CA TB 117-2013

US ACT: AATCC 16 Light fastness - pass, AATCC 8 or 116 wet/dry crocking- pass, CA TB 117-2013

- pass, ASTM D4157-02 WYZ

Abrasion (Heavy Duty Upholstery) - pass, ASTM D3511 Pilling - pass

go check gabriel
composizione / composition / composition / Zusammensetzung / composición: 100% Trevira CS
<p>prove / tests / tests / Test / pruebas: Abrasion resistance rubs BS EN 14465 - BS EN ISO 12947-2: 80.000 Martindale; double rubs Wizenbeek ASTM D4157-07 (Heavy Duty Upholstery) 60.000 Pilling EN ISO 12945-2: 5</p> <p>Colour fastness to light UNI EN ISO 105-B02: 5/8</p> <p>Colour fastness to rubbing ISO 105-X12: dry 4/5, wet 4/5</p> <p>Fire resistance: EN 1021 Part 1&2, BS 5852 0&1, BS 5852 Crib 5, DIN 4102 B1, UNI 9175 Class 1.IM, FAR/JAR 25.853, ONORM B 3825 B1-Q1, NFP92-502-M1, BS 7176 Medium Hazard, DIN EN 13501-1-B-s1, d0, CA TB 117-2013</p> <p>US ACT: AATCC 16 Light fastness - pass, AATCC 8 or 116 wet/dry crocking- pass, CA TB 117-2013</p> <p>- pass, ASTM D4157-02 WYZ</p> <p>Abrasion (Heavy Duty Upholstery) - pass, ASTM D3511 Pilling - pass</p>

prove / tests / tests / Test / pruebas: Abrasion resistance rubs BS EN 14465 - BS EN ISO 12947-2: 80.000 Martindale; double rubs Wizenbeek ASTM D4157-07 (Heavy Duty Upholstery) 60.000 Pilling EN ISO 12945-2: 5
Colour fastness to light UNI EN ISO 105-B02: 5/8
Colour fastness to rubbing ISO 105-X12: dry 4/5, wet 4/5
Fire resistance: EN 1021 Part 1&2, BS 5852 0&1, BS 5852 Crib 5, DIN 4102 B1, UNI 9175 Class 1.IM, FAR/JAR 25.853, ONORM B 3825 B1-Q1, NFP92-502-M1, BS 7176 Medium Hazard, DIN EN 13501-1-B-s1, d0, CA TB 117-2013 US ACT: AATCC 16 Light fastness - pass, AATCC 8 or 116 wet/dry crocking- pass, CA TB 117-2013 <p>- pass, ASTM D4157-02 WYZ</p> <p>Abrasion (Heavy Duty Upholstery) - pass, ASTM D3511 Pilling - pass</p>

crazy flukso
composizione / composition / composition / Zusammensetzung / composición: 80% PVC, 2% PU, 18% PL
<p>prove / tests / tests / Test / pruebas: Abrasion resistance EN ISO 5470-2: 50.000 Martindale</p> <p>Colour fastness to rubbing UNI EN ISO 105-X12: dry 4/5, wet 4/5</p> <p>Adhesion UNI EN ISO 2411: 35 N</p> <p>Bending strength UNI 4818-13: 150.000 cycles</p> <p>Tensile strength UNI EN ISO 1421: long 515 N, trasv. 300 N</p> <p>Fire resistance: UNI 9175 Classe 1.IM, EN 1021:2</p>

solids & stripes sunbrella
composizione / composition / composition / Zusammensetzung / composición: 100% Sunbrella Acrylic

composizione / composition / composition / Zusammensetzung / composición: 100% Sunbrella Acrylic

prove / tests / tests / Test / pruebas: Tensile strength ISO 13934-1: warp 160 daN, weft 90 daN
Elongation at break ISO 13934-1: warp 33%, weft 26%
Schmerber ISO 811: 200mm
Stitching strength ISO 13935-2: warp 42.9 daN, weft 51.1 daN
Colour fastness to light UNI EN ISO 105-B02: indoor 8, outdoor 4-5
Colour fastness to rubbing ISO 105-X12: dry 5, wet 5

rivet camira
composizione / composition / composition / Zusammensetzung / composición: 100% PL (recycled)

composizione / composition / composition / Zusammensetzung / composición: 100% PL (recycled)

prove / tests / tests / Test / pruebas: Abrasion resistance: >50.000 Martindale
Colour fastness to light UNI EN ISO 105 B02: 6
Colour fastness to rubbing ISO 105-X12: dry 4, wet 4
Fire resistance: EN 1021 Part 1&2, BS 7176 Low Hazard

valencia spradling
composizione / composition / composition / Zusammensetzung / composición: 100% PL

composizione / composition / composition / Zusammensetzung / composición: 100% PL

prove / tests / tests / Test / pruebas: Abrasion resistance: > 300.000 Martindale
Antimicrobial: Antifungal protection, antibacterial protection, Antimycotic protection
UV resistance: 1000 hours, blue wool scale
Fire resistance: NF P-92-503 / M2, EN 1021, Part 1&2, DIN 4102 B2, ONORM B 3825
Gruppe1 - schwerbrennbares verhalten, ONORM A 3800
Teil 1 Qualmbildungsklasse Q1-schwachqualmend, IMO Res. MSC.307 (88) (2010 FTP Code)
Annex 1 Part 8, (MED) Marine Equipment Directive in its current valid version
UNI 9175/87 / UNI 9175/FAI (1994) Classe 1.IM, UNE 23.727-90 IR/M2, EN 71-2: 2006+A1:2007 Safety of Toys-Part 2: Flammability, ECE R 11 8 (replaces Directive 95/28/CE), FMVSS 302, FAR 25/853

composizione / composition / composition / Zusammensetzung / composición: 95% WO, 5% PL
prove / tests / tests / Test / pruebas: Abrasion resistance rubs BS EN ISO 12947-2: 200.000 Martindale <p>Pilling EN ISO 12945-2: 4</p> <p>Colour fastness to light EN ISO 105-B02: 5/7</p> <p>Colour fastness to rubbing ISO 105-X12: dry 4/5, wet 4/5</p> <p>Fire resistance: EN 1021 Part 1&2, BS 5852 0&1, BS 5852 Crib 5, BS 476 Part 7 class 1, AM 18, NF D 60-013, CA TB 117-2013, UNI 9175 Classe 1.IM, IMO MSC 307(88) Annex 1 part 8/MED Certificate IMO, ONORM B 3825 B1, 3800 Q1.</p> <p>US ACT: AATCC 16 Light fastness - pass, AATCC 8 or 116 wet/dry crocking- pass, CA TB 117-2013 - pass, ASTM D4966-02 Martindale (Heavy Duty) - pass, ASTM D3511 Pilling - pass</p>

cat g

criss cross gabriel
composizione / composition / composition / Zusammensetzung / composición: 89% WO, 11% PA
<p>prove / tests / tests / Test / pruebas: Abrasion resistance rubs BS EN 14465 - EN ISO 12947-2: 110.000 Martindale</p> <p>Pilling EN ISO 12945-2: 4/5</p> <p>Colour fastness to light UNI EN ISO 105 B02: 5/7</p> <p>Colour fastness to rubbing EN ISO 105 X12: dry 4/5, wet 4/5</p> <p>Fire resistance: EN 1021 Part 1&2, BS 5852 0&1, CA TB 117-2013</p> <p>US ACT: AATCC 16 Light fastness - pass, AATCC 8 or 116 wet/dry crocking- pass, CA TB 117-2013</p> <p>- pass, ASTM D4966 Martindale (Heavy Duty) - pass, ASTM D3511 Pilling - pass</p>

prove / tests / tests / Test / pruebas: Abrasion resistance rubs BS EN 14465 - EN ISO 12947-2: 110.000 Martindale
Pilling EN ISO 12945-2: 4/5
Colour fastness to light UNI EN ISO 105 B02: 5/7
Colour fastness to rubbing EN ISO 105 X12: dry 4/5, wet 4/5 <p>Fire resistance: EN 1021 Part 1&2, BS 5852 0&1, CA TB 117-2013</p> <p>US ACT: AATCC 16 Light fastness - pass, AATCC 8 or 116 wet/dry crocking- pass, CA TB 117-2013</p> <p>- pass, ASTM D4966 Martindale (Heavy Duty) - pass, ASTM D3511 Pilling - pass</p>

europost 2 gabriel
composizione / composition / composition / Zusammensetzung / composición: 100% WO
<p>prove / tests / tests / Test / pruebas: Abrasion resistance rubs BS EN 14465 - BS EN ISO 12947-2: 50.000 Martindale</p> <p>Pilling EN ISO 12945-2: 4</p> <p>Colour fastness to light UNI EN ISO 105 B02: 5/7</p> <p>Colour fastness to rubbing EN ISO 105 X12: dry 4/5, wet 4/5</p> <p>Fire resistance: BS 5852 Part 1 0+1 Cigarette & Match, ONORM B 3825-B2-3800-Q1 UK, UNI 9175 Classe 1.IM,</p>

BS EN 1021 Part 1&2, IMO MSC 307(88) Annex 1 Part 8, MED Certificate IMO, ASTM E 84, NFPA 286 Room corner fire test, CA TB 117-2013, DIN 4102 B2, BS 476 Part 7 class 1.

US ACT: AATCC 16 Light fastness - pass, AATCC 8 or 116 wet/dry crocking- pass, ASTM E 84 NFPA 286 Room corner fire test CA TB 117-2013 - pass

fame gabriel
composizione / composition / composition / Zusammensetzung / composición: 95% WO, 5% PL

prove / tests / tests / Test / pruebas: Abrasion resistance rubs BS EN ISO 12947-2: 200.000 Martindale
Pilling EN ISO 12945-2: 4
Colour fastness to light EN ISO 105-B02: 5/7
Colour fastness to rubbing ISO 105-X12: dry 4/5, wet 4/5 <p>Fire resistance: EN 1021 Part 1&2, BS 5852 0&1, BS 5852 Crib 5, BS 476 Part 7 class 1, AM 18, NF D 60-013, CA TB 117-2013, UNI 9175 Classe 1.IM, IMO MSC 307(88) Annex 1 part 8/MED Certificate IMO, ONORM B 3825 B1, 3800 Q1.</p> <p>US ACT: AATCC 16 Light fastness - pass, AATCC 8 or 116 wet/dry crocking- pass, CA TB 117-2013 - pass, ASTM D4966-02 Martindale (Heavy Duty) - pass, ASTM D3511 Pilling - pass</p>

bubble flukso
composizione / composition / composition / Zusammensetzung / composición: 100% PL

composizione / composition / composition / Zusammensetzung / composición: 100% PL
prove / tests / tests / Test / pruebas: Colour fastness to rubbing UNI EN ISO 105-X12: grey scale, dry 4/5, wet 4/5
Colour fastness to light UNI EN ISO 105-B02: blue scale 5/6
Fire resistance: UNI 9175 Classe 1.IM, EN 1021 Part 1&2, BS 5852:2006 (part 11 Crib 5). Potential FR Classes: M1 (F), classe 1 (I), B1 (D), BT117 (USA).
Abrasion resistance UNI EN ISO 12947-2: 35.000 Martindale

parotega nf skai hornschuch
composizione / composition / composition / Zusammensetzung / composición: 85% PVC, 15% CO
<p>prove / tests / tests / Test / pruebas: Abrasion resistance 75.000 Martindale.</p> <p>Colour fastness to light (xenotest) UNI EN ISO 105 B02: 7</p> <p>Fire resistance: DIN EN 4102-1 (Part 1, B1) Baustoffklasse B1, NF M1, BS 5852 Ignition Source 0+1+5, EN 1021 Part 1&2, MVSS302, DIN 53438 (Part 2), FAR 25.853, ONORM B3825 schwer brennbar (B1), ONORM A 3800-1 Q1, UNI 9175 Classe 1.IM, DIN 66084 P-a</p>

balta vesoom
composizione / composition / composition / Zusammensetzung / composición: 80% WO, 20% PA

prove / tests / tests / Test / pruebas: Abrasion resistance ISO 12947-2: >100.000 Martindale

Pilling EN ISO 12945-2: 4

Colour fastness to rubbing ISO 105-X12: dry 4/5, wet 4/5

Colour fastness to light UNI EN ISO 105-B02: 4/5

Fire resistance: BS 5852 crib 5, NF P92-503-507 M2, DIN 4102 B2

main line flax camira
composizione / composition / composition / Zusammensetzung / composición: 70% WO, 30% LI
<p>prove / tests / tests / Test / pruebas: Abrasion resistance: >35.000 Martindale</p> <p>Colour fastness to light UNI EN ISO 105-B02: 5</p> <p>Colour fastness to rubbing ISO 105-X12: dry 4, wet 3</p> <p>Fire resistance: EN 1021 Part 1&2, BS 7176 Low Hazard, BS 5852 Ignition Source 5, BS 7176 Medium Hazard, BS 5867-2 Type B Curtains&Drapes, UNI 9175 Classe 1.IM, ONORM B3825 & A 3800-1 Pilling - pass</p>

superb trevira flukso
composizione / composition / composition / Zusammensetzung / composición: 100% TREVIRA® CS
<p>prove / tests / tests / Test / pruebas: Abrasion resistance rubs EN ISO 12947-2: 100.000 Martindale</p> <p>Pilling EN ISO 12945-2: 4</p> <p>Colour fastness to light UNI EN ISO 105-B02: 5/7</p> <p>Fire resistance: EN 1021 Part 1&2, BS 5852 Part 1, DIN 4102 B2, ONORM B1/Q1, NF D 60-013, UNI 9175 Classe 1.IM, US Cal. Bull. 117-2013, AS/NZS 3837 Class 2, IMO FTP Code 2010:Part 8, Crib 5 and SN 198 898 5.3 with treatment. AS/NZS 1530.3 NF PA 260</p>

prove / tests / tests / Test / pruebas: Fire resistance: UNI 9175 classe 1 IM
UNI 9177 class 1
EN 1021-2
BS 5852 Crib 5
DIN 4102 -1 B1
NF92.503 – M1

cat l

remix 2 kvadrat
composizione / composition / composition / Zusammensetzung / composición: 90% WO, 10% Nylon

composizione / composition / composition / Zusammensetzung / composición: 90% WO, 10% Nylon

prove / tests / tests / Test / pruebas: Abrasion resistance rubs BS EN ISO 12947-2: 100.000 Martindale

Pilling EN ISO 12945-2: 4

Colour fastness to light UNI EN ISO 105 B02: 5/7

Fire resistance: EN 1021 Part 1&2, BS 5852 Part 1, ONORM B1/Q1, NF D 60-013, UNI 9175 Classe 1.IM US Cal. Bull. 117-2013 AS/NZS 1530.3, IMO FTP Code 2010:Part 8, Crib 5 BS 5852.

revive 2 kvadrat
composizione / composition / composition / Zusammensetzung / composición: 100% PL

composizione / composition / composition / Zusammensetzung / composición: 100% PL

prove / tests / tests / Test / pruebas: Abrasion resistance rubs BS EN ISO 12947-2: 60.000 Martindale

Pilling EN ISO 12945-2: 4/5

Colour fastness to light UNI EN ISO 105-B02: 5/7

Fire resistance: EN 1021 Part 1&2, DIN 4102 B1, ONORM B1/Q1, UNI 9175 Classe 1.IM, US Cal. Bull. 117-2013, IMO FTP CODE 2010 part 8. NF D60 013 with treatment, BS 5852 CRIB 5 with treatment.

cat m

steelcut trio 3 kvadrat
composizione / composition / composition / Zusammensetzung / composición: 90% WO, 10% Nylon

composizione / composition / composition / Zusammensetzung / composición: 90% WO, 10% Nylon
prove / tests / tests / Test / pruebas: Abrasion resistance rubs EN ISO 12947-2: 100.000 Martindale
Pilling EN ISO 12945-2: 4
Colour fastness to light UNI EN ISO 105-B02: 5/7
Fire resistance: EN 1021 Part 1&2, BS 5852 Part 1, DIN 4102 B2, ONORM B1/Q1, NF D 60-013, UNI 9175 Classe 1.IM, US Cal. Bull. 117-2013, AS/NZS 3837 Class 2, IMO FTP Code 2010:Part 8, Crib 5 and SN 198 898 5.3 with treatment. AS/NZS 1530.3 NF PA 260

finiture telai /
frames finishes /
finitions piètements /
gestellfertigungen /
acabados estructuras

acciaio / steel / acier /
stahl / acero

AC

acciaio / steel / acier / stahl / acero



* disponibile solo per alcuni prodotti - vedi listino prezzi / Available only for selected products - see price list / Disponible seulement pour certains produits, voir la liste de prix / Nur für einige Produkte verfügbar - Siehe Preisliste / Disponible solamente para algunos productos - ver Lista de Precios.

Salinero solo / only / seulement / nur / solamente
RAL 9005
VR Nero intenso opaco / VR Matt Jet Black / VR Noir foncé opaque / VR Matt Tiefschwarz / VR Negro intenso mate



RAL 9016
VR Bianco traffico / VR Traffic white / VR Blanc signalisation / VR Verkehrsweiß / VR Blanco tráfico



RAL 9010
VR Bianco puro / VR Pure white / VR Blanc pur / VR Reinweiß / VR Blanco puro



PANTONE 402 C
VR Tortora / VR Turtle-dove / VR Gris tourterelle / VR Taubengrau / VR Tortora



RAL 9006
VR Alluminio brillante / VR White aluminium / VR Aluminium blanc / VR Weißaluminium / VR Aluminio blanco



VR Peltro / VR Pewter / VR Etain / VR Zinn / VR Peltre

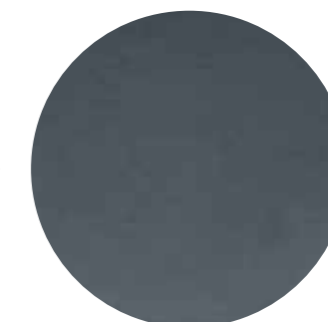

RAL 7016
VR Grigio antracite / VR Anthracite grey / VR Gris anthracite / VR Anthrazitgrau / VR Gris antracita



RAL 9005
VR Nero intenso / VR Jet black / VR Noir foncé / VR Tiefschwarz / VR Negro intenso

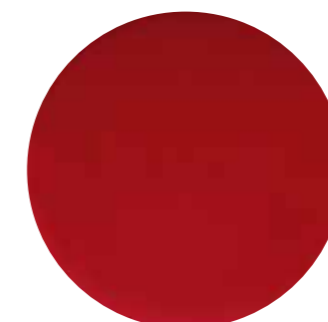

RAL 3003
VR Rosso rubino / VR Ruby red / VR Rouge rubis / VR Rubinrot / VR Rojo rubí

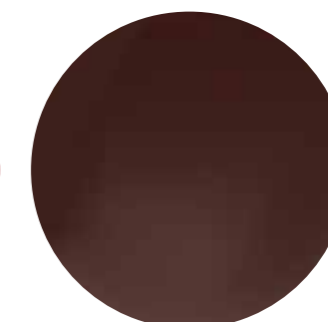

RAL 8017
VR Marrone cioccolata / VR Chocolate brown / VR Brun chocolat / VR Schokoladenbraun / VR Chocolate



RAL 9005
VR Nero intenso opaco / VR
Matt Jet Black / VR Noir foncé
opaque / VR Matt Tiefschwarz
/VR Negro intenso mate



RAL 7037
VR Grigio polvere opaco /
VR Matt Dusty grey /
VR Gris poussière opaque /
VR Matt Staubgrau /
VR Gris polvo mate



VR Bronzo metallico bucciato /
VR Rough metallic bronze /
VR Bronze métallique texturé /
VR Rau Metallbronze /
VR Bronce metálico áspero

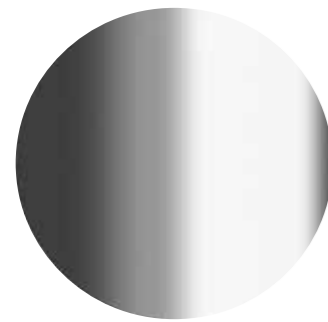

* CR Cromato /
CR Chrome /
CR Chromé /
CR Verchromt /
CR Cromado



* CR X Cromato
brunito / CR X Burnished
chrome / CR X Chromé
noir /
CR X Bruniert verchromt /
CR X Cromado bruno

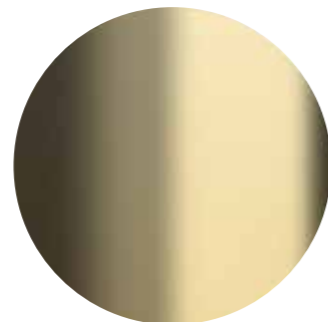

* CR X Cromato ottonato /
CR X Brass chrome /
CR X Chromé laiton /
CR X Vermessingt
verchromt / CR X Latón
cromado



* CR S Cromato
satinato / CR S Satin
chrome / CR S Chromé
satiné / CR S Matt
verchromt / CR S
Cromado satinado

AX

acciaio inox AISI 304 18/10 / AISI 304 18/10 stainless steel /
acier inoxydable AISI 304 18/10 / AISI 304 18/10 Edelstahl /
acero inoxidable AISI 304 18/10

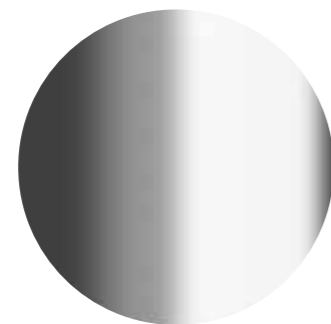

LUC Lucido /
LUC Gloss /
LUC Brillant /
LUC Poliert /
LUC Pulido



SAT Satinato /
SAT Satin /
SAT Satiné /
SAT Matt /
SAT Satinado

alluminio / aluminium / aluminium / aluminium / aluminio

AL

alluminio / aluminium / aluminium / aluminium / aluminio

AL AND

alluminio anodizzato / anodised aluminium / aluminium anodisé /
eloxiertes aluminium / aluminio anodizado



* solo / only /
seulement / nur /
solamente Marè



* Nero satinato / Matt
Black / Noir satiné
Matt Schwarz / Negro
satinado



* Bronzo satinato /
Matt bronze / Bronze
satiné / Matt Bronze /
Bronze satinado

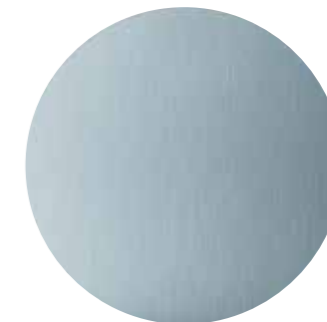

* Fumé satinato /
Matt smoked /
Fumé satiné /
Matt Rauchgrau /
Ahumado satinado



Alluminio anodizzato
lucido / Anodized
gloss aluminium /
Aluminium anodisé
brillant / Eloxiertes
Glanzaluminium /
Aluminio anodizado
pulido

AL PSH

alluminio lucidato / polished aluminium /
aluminium brillant / poliertes aluminium /
aluminio pulido

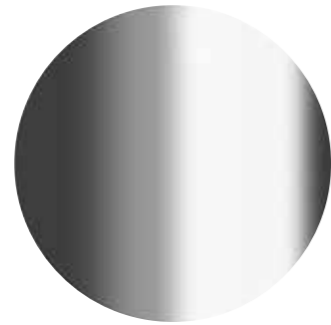

Alluminio lucidato /
Polished aluminium /
Aluminium brillant /
Poliertes Aluminium /
Aluminio pulido

AL VR

alluminio verniciato / painted aluminium /
aluminium verni / lackiert aluminium / aluminio barnizado



* solo / only /
seulement / nur /
solamente
Ax, Ex, Mx

Agatha 046-DP,
046-DR
Ibis 002-DP,
002-DR
Kicca 021-DP,
021-DR
Marka 569-DP,
569-DR
Uni 558-DP,
558-DR, 558M-DP,
558M-DR
Uni-Ka 597-DP,
597-DR, 597M-DP,
597M-DR
solo/only/
seulement/ nur/
solamente

RAL 9005
VR Nero intenso/
VR Jet black /
VR Noir foncé /
VR Tiefschwarz /
VR Negro intenso

Myra 677, 678, 683
solo / only /
seulement / nur /
solamente
RAL 9005
VR Nero intenso
opaco / VR Matt
Jet Black / VR Noir
foncé opaque /
VR Matt
Tiefschwarz /
VR Negro intenso
mate



* RAL 9016
VR Bianco traffico /
VR Traffic white /
VR Blanc signalisation /
VR Verkehrsweiß /
VR Blanco tráfico



RAL 9010
VR Bianco puro /
VR Pure white /
VR Blanc pur /
VR Reinweiß /
VR Blanco puro



PANTONE 402 C
VR Tortora /
VR Turtle-dove /
VR Gris tourterelle /
VR Taubengrau /
VR Tortora



* RAL 9006
VR Alluminio brillante /
VR White aluminium /
VR Aluminium blanc /
VR Weißaluminium /
VR Aluminio blanco



* VR Peltro /
VR Pewter / VR Etain /
VR Zinn / VR Peltre

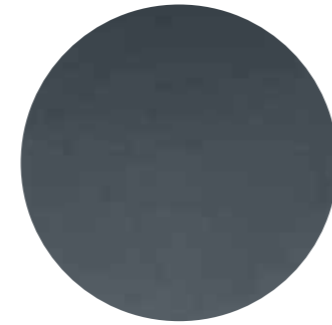

* RAL 7016
VR Grigio antracite /
VR Anthracite grey /
VR Gris anthracite /
VR Anthrazitgrau /
VR Gris antracita



RAL 9005
VR Nero intenso /
VR Jet black /
VR Noir foncé /
VR Tiefschwarz /
VR Negro intenso

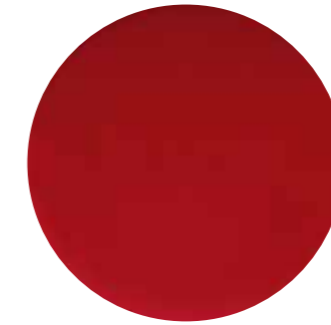

RAL 3003
VR Rosso rubino /
VR Ruby red /
VR Rouge rubis /
VR Rubinrot /
VR Rojo rubí

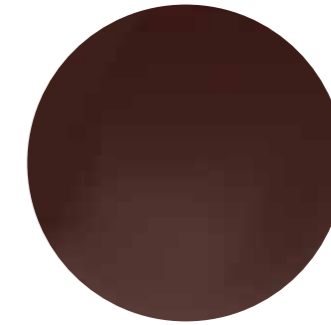

RAL 8017
VR Marrone cioccolata /
VR Chocolate brown /
VR Brun chocolat /
VR Schokoladenbraun /
VR Chocolate



RAL 9005
VR Nero intenso opaco /
VR Matt Jet Black /
VR Noir foncé opaque /
VR Matt Tiefschwarz /
VR Negro intenso mate

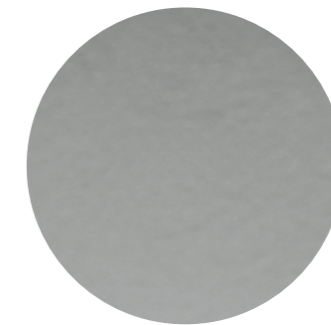

* RAL 7037
VR Grigio polvere opaco /
VR Matt Dusty grey /
VR Gris poussière opaque /
VR Matt Staubgrau /
VR Gris polvo mate



* VR Bronzo metallico
bucciato / VR Rough
metallic bronze / VR
Bronze métallique texturé
/ VR Rau Metallbronze /
VR Bronce metálico
áspero

legno / wood / bois /
holz / maderera

LE

faggio



Faggio tinto acero /
Maple stained beech
wood / Hêtre teinté
érable / Buche
Ahorn gefärbt /
Haya tenida arce



Faggio naturale /
Natural beech wood /
Hêtre naturel /
Buche Natur /
Haya natural



Faggio tinto rovere /
Oak stained beech
wood / Hêtre teinté
chêne / Buche Eiche
gefärbt / Haya tenida
roble



Faggio tinto noce
canaletto / Canaletto
Walnut stained beech
wood / Hêtre teinté
noyer canaletto / Buche
Nussbaum Canaletto
gefärbt / Haya tenida
nogal Canaletto



Faggio tinto wengé /
Wengé stained beech
wood / Hêtre teinté
wengé / Buche
wengé gefärbt /
Haya tenida wengé



Faggio tinto nero /
Black stained beech
wood / Hêtre teinté
noir / Buche
Schwarz gefärbt /
Haya tenida negro

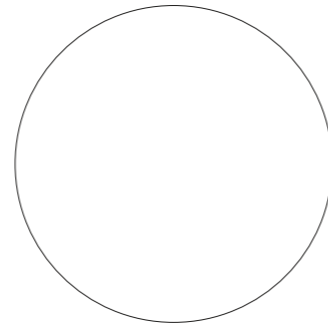

Faggio tinto campione / Beech wood,
stained according to sample /
Hêtre teinté selon échantillon /
Kundenmuster gefärbt / Haya tenida
según muestra

Ordine minimo 10 pz / Minimum order 10
pcs / Minimum de commande 10 pièces /
Mindestbestell 10 Stück / Minimo de
compra 10 piezas

frassino



Frassino tinto acero /
Maple stained ash
wood / Frêne teinté
érable / Esche Ahorn
gefärbt / Fresno
tenido arce



Frassino naturale /
Natural ash wood /
Frêne naturel / Esche
Natur / Fresno natural



Frassino tinto rovere /
Oak stained ash
wood / Frêne teinté
chêne / Esche Eiche
gefärbt / Fresno
tenido roble

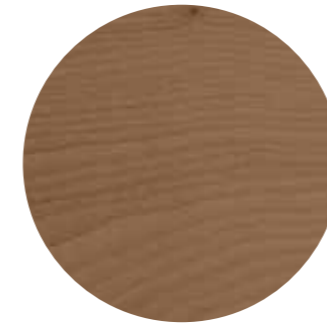

Frassino tinto noce
canaletto / Canaletto
Walnut stained ash
wood / Frêne teinté
noyer Canaletto /
Esche Nussbaum
Canaletto gefärbt /
Fresno tenido nogal
Canaletto

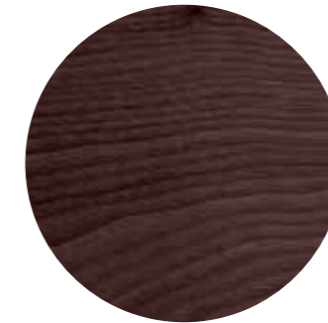

Frassino tinto wengé /
Wengé stained ash
wood / Frêne teinté
wengé / Esche Wengé
gefärbt / Fresno
tenido wengé

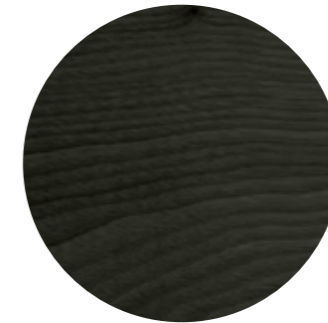

Frassino tinto nero /
Black stained ash
wood / Frêne teinté
noir / Esche Schwarz
gefärbt / Fresno tenido
negro

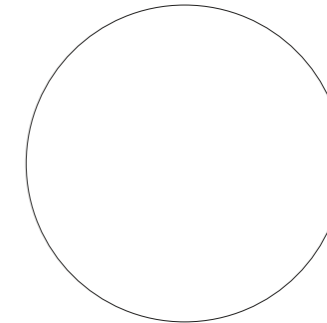

Frassino tinto campione / Ash wood,
stained according to sample / Frêne
teinté selon échantillon / Kundenmuster
gefärbt / Fresno tenido según muestra

Ordine minimo 10 pz / Minimum order 10
pcs / Minimum de commande 10 pièces /
Mindestbestell 10 Stück / Minimo de
compra 10 piezas

laminato / laminate / stratifié /
laminat / laminado

LAM

Solo come finitura per fianco, zoccolo e retro panca Space (vedi pag 408, cat. J, K).
Solo come finitura per Deck (vedi pag 408-410, cat. J, K e E), tranne gli articoli 501C,
502C, 503C (solo in cat. J, K) /
Finishing available for side, front and back of Space bench only (see p. 408, cat. J, K).
Finishing available for Deck only (see p. 408-410, cat. J, K and E), except art.
Nr 501C, 502C, 503C (cat. J, K only) /
Finition disponible uniquement pour coté, plinthe et dossier de banquette Space
(voir p. 408, cat. J, K). Finition disponible uniquement pour Deck (voir p. 408-410,
cat. J, K et E), sauf art. 501C, 502C, 503C (cat. J, K uniquement) /
Fertigung nur für Seite, Sockel und Hinten von Space Bänke (siehe Seite 408,
Kat. J, K). Fertigung nur für Deck (siehe S. 408-410, Kat. J, K und E) außer art.
501C, 502C, 503C (nur in Kat. J, K) /
Solamente como acabado por lado, base frente y trasera de las banquetas Space
(veer pág. 408, cat. J, K). Solamente como acabado por Deck (veer pág. 408-410,
cat. J, K y E) excepto art. 501C, 502C, 503C (solamente cat. J, K)

finiture piani tavoli /
table tops finishes /
finitions plateaux de table /
tischplattenfertigungen /
acabados por sobres
de mesas

piani per esterno in resina stampati
ad alta pressione rivestiti con
film decorativo / resin-coated
top for outdoor use / plateau
avec revêtement en résine pour
utilisation en extérieur / tischplatte
aus harz für den aussenbereich /
sobres de mesa en resina para
utilización ex exteriores

WRZ

werzalit



Bianco / White /
Blanc / Weiss /
Blanco

stratificato HPL / HPL solid
 laminate / stratifié HPL / HPL
 compact platte / estratificado HPL

STR

- Bianco / White / Blanc / Weiss / Blanco
- Grigio argento / Silver grey / Gris argent / Silbergrau / Grisplata
- Moka / Mocha / Moka / Mokka / Moka
- Beige / Beige / Beige / Beige / Beige
- Antracite / Anthracite / Anthracite / Anthrazit / Antracita
- Taberna / Taberna / Taberna / Taberna / Taberna /
- Peltro opaco / Matt pewter / Etain opaque / Matt Zinn / Peltre mate
- Cemento / Concrete / Ciment / Zement / Hormigón



full color



Bianco / White /
 Blanc / Weiss /
 Blanco

compact

cat. A



Bianco / White / Blanc /
 Weiss / Blanco

cat. B

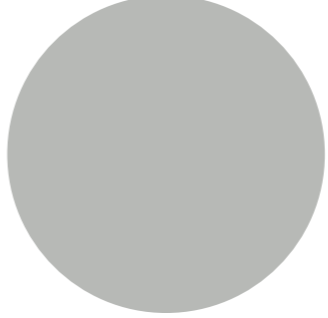

Grigio argento / Silver
 grey / Gris argent /
 Silbergrau / Grisplata

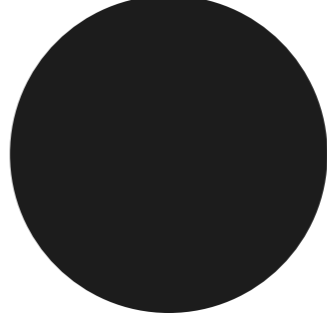

Nero / Black / Noir /
 Schwarz / Negro

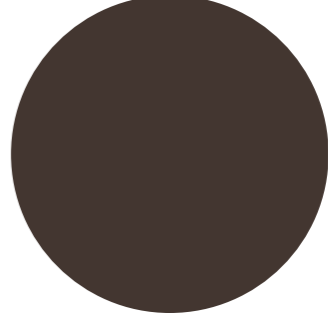

Moka / Mocha /
 Moka / Mokka /
 Moka



Beige / Beige /
 Beige / Beige /
 Beige

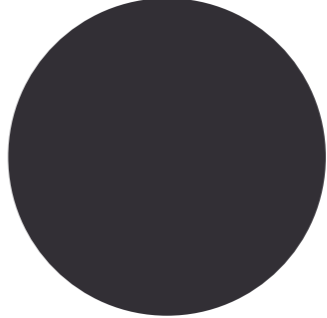

Antracite / Anthracite /
 Anthracite / Anthrazit /
 Antracita

cat. C



Wood / Wood /
 Wood / Wood /
 Wood /



Robur / Robur /
 Robur / Robur /
 Robur

cat. E



Taberna / Taberna /
Taberna / Taberna /
Taberna /

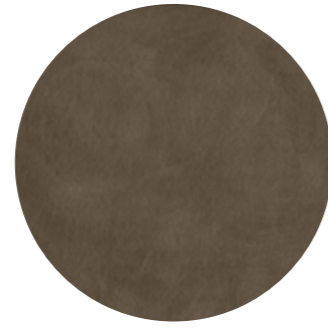

Peltro opaco / Matt pewter /
Etain opaque / Matt Zinn /
Peltre mate

Dalton,
Salinero

piani / table tops /
plateaux /
tischplatten /
sobres de mesas



Full color
Bianco / White /
Blanc / Weiss /
Blanco

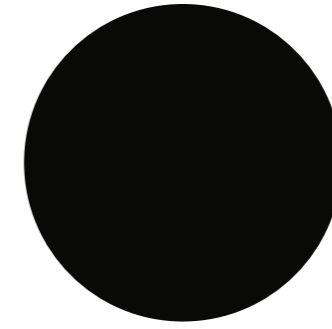

Compact
Nero / Black /
Noir / Schwarz /
Negro
DS

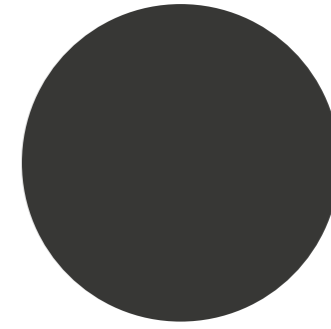

Compact
Grafite / Graphite /
Graphite / Graphite /
Grafito

Antimpronta /
Anti-fingerprints /
Anti-empreinte /
Anti Fingerabdrücke /
Antihuella

cat. F



Cemento / Concrete /
Ciment / Zement /
Hormigón

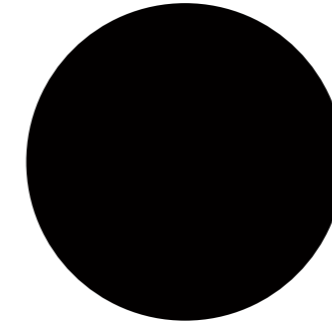

Compact
Fenix NTM 0720 Nero Ingo

Antimpronta / Anti-fingerprints /
Anti-empreinte / Anti
Fingerabdrücke / Antihuella

cat. G

Antimpronta /
Anti-fingerprints /
Anti-empreinte /
Anti Fingerabdrücke /
Antihuella

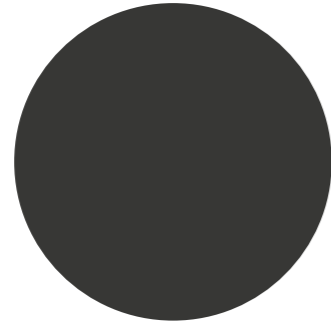

Grafite / Graphite /
Graphite / Graphite /
Grafito

cat. H

Antimpronta /
Anti-fingerprints /
Anti-empreinte /
Anti Fingerabdrücke /
Antihuella

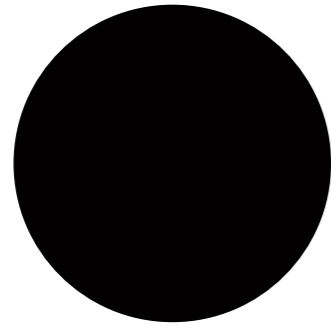

Fenix NTM 0720
Nero ingo

laminato / laminate / stratifié /
laminat / laminado

LAM

cat. J



Arpa 20



Arpa 1286

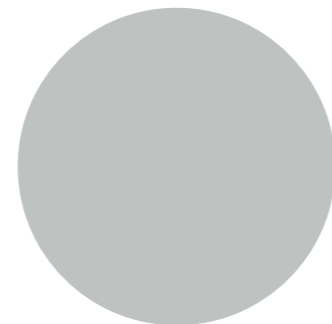

Arpa 211

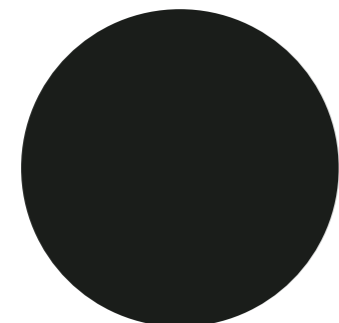

Arpa 509



Abet 313

cat. K



Abet 385



Arpa 4420

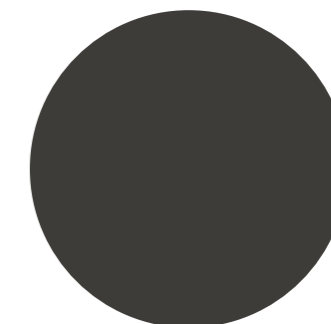

Arpa 526



Arpa 244



Arpa 1890

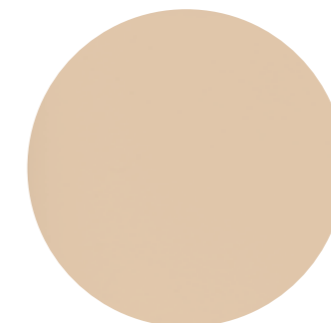

Abet 416

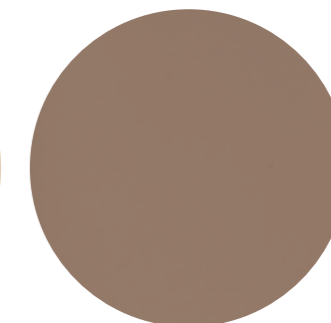

Abet 893



Lamicolor 778



Lamicolor 788



Abet 545



Arpa 4585

legenda / index / légende / zeichenerklärung / leyenda

cat. E



Egger H3840
ST9



Egger H1199
ST12

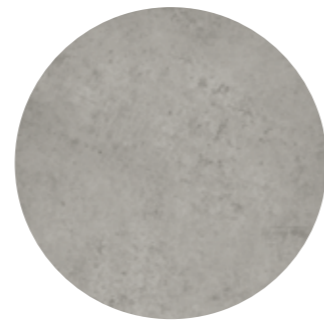

Egger F186
ST9

cat. H

Antimpronta /
Anti-fingerprints /
Anti-empainte /
Anti Fingerabdrücke /
Antihuella

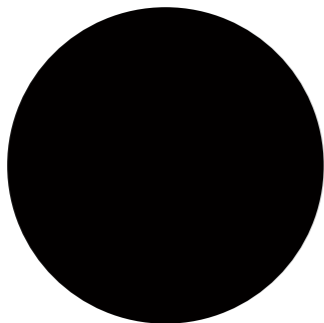

Fenix NTM 0720 Nero Ingo



Per esterni nelle finiture idonee /
For outdoor use, in the suitable
finishes / Pour l'extérieur, dans
certaines finitions / Für aussen, in
den geeigneten Ausführungen /
Para utilización ex exteriores, en los
acabados adecuados



Resistente a salsedine, cloro e
acque termali nelle finiture idonee /
Resistant to salty environments,
chlorine and thermal waters - in
the suitable finishes / Résistant à la
salinité, chlore et eaux thermales,
dans certaines finitions / Beständig
gegen salzhaltige Umgebung,
Chlor und Thermalwasser, in
den geeigneten Ausführungen /
Resistente a la salinidad, cloro y
aguas termales, en los acabados
adecuados



Meccanismo di ritorno / Kick-back
device / Mechanisme de retour /
Automatischer zurück Systeme /
Sistema de vuelta



Riciclabile / Recyclable /
Recyclable / Recycling / Reciclable



Girevole / Swivelling / Pivotant /
Drehbar / Giratorio

AC

Acciaio / Steel / Acier / Stahl / Acero

AL

Alluminio / Aluminium /
Aluminium / Aluminium / Aluminio

AL AND

Alluminio Anodizzato / Anodised
Aluminium / Aluminium Anodisé /
Eloxiertes Aluminium / Aluminio
Anodizado

AL PSH

Alluminio Lucidato / Polished
Aluminium / Aluminium Brilliant
Poliertes Aluminium / Aluminio
Pulido

AL VR

Alluminio Verniciato / Painted
aluminium / Aluminium verni /
Lackiert Aluminium / Aluminio
barnizado

AX

Acciaio Inox / Stainless Steel /
Acier Inoxydable / Edelstahl /
Acero Inoxidable

CO

Cotone / Cotton / Coton /
Baumwolle / Algodón

COM

Tessuto fornito dal cliente /
Customer own material / Tissu
client / Kundenstoff / Tela cliente

CR

Cromato / Chrome / Chromé /
Verchromt / Cromado

CR S

Cromato satinato / Satin chrome /
Chromé satiné / Matt Verchromt /
Cromado satinado

CR X

Cromato brunito, Cromato
ottonato / Burnished chrome,
Brass chrome / Chromé noir,
Chromé laiton / Bruniert
verchromt, Vermessingt
verchromt / Cromado bruno,
Latón cromado

LAM

Laminato / Laminate /
Stratifié / Laminat / Laminado

LE

Legno / Wood / Bois / Holz / Madera

LI

Lino / Linen / Lin / Leinen / Lino

PA

Poliamide / Polyamide /
Polyamide / Polyamid / Poliamida

PE

Polietilene / Polyethylene /
Polyéthylène / Polyäthylen /
Polietileno

PL

Poliestere / Polyester / Polyester /
Polyester / Poliéster

PP

Polipropilene / Polypropylene /
Polypropylène / Polypropylen /
Polipropileno /

PP + PET

Tecnopolimero composito
multistrato a densità variabile
(polipropilene + polietilene
tereftalato) / Multi-layer variable
density man-made Composite
polymer (polypropylene +
Terephthalate polyethylene) /
Techno-polymère composite
multicouche à densité variable
(polypropylène + Polyéthylène
téréphthalate) / Zusammengesetztes
mehrschichtiges Technopolymere
mit wechselbarer dichte
(Polypropylen + Polyäthylen-
terephthalat) / Tecnopolimero
compuesto multicapas de densidad
variable (polipropileno + Polietileno
tereftalato)

PU

Poliuretano / Polyurethane /
Polyuréthane / Polyurethan /
Poliuretano

STR

Stratificato HPL / HPL Solid
Laminate / Stratifié HPL / HPL
Compactplatte / Estratificado HPL

TE

Tessuto / Fabric / Tissu /
Stoff / Tejido

VR

Verniciato / Paint Finishing / Verni /
Lackiert / Barnizado

WO

Lana / Wool / Laine / Wolle / Lana

WRZ

Piani per esterno in resina stampati
ad alta pressione rivestiti con
film decorativo / Resin-coated
top for outdoor use / Plateau
avec revêtement en résine pour
utilisation en extérieur /
Tischplatte aus harz für den
ausenbereich / Sobre de mesa en
resina para utilización ex exteriores

XLP

Xiloplast / Xiloplast / Xiloplast /
Xiloplast / Xiloplast

uso e manutenzione - pulizia / use and maintenance - cleaning / utilisation et entretien - nettoyage / gebrauch und wartung - reinigung / uso y mantenimiento - limpieza

Istruzioni generali per l'utilizzo dei prodotti Et al.

Al fine di garantire la durata nel tempo dei prodotti Et al., consigliamo di verificare periodicamente il corretto serraggio delle viti e di tenerli lontano da fonti di calore. Le sedute vanno utilizzate con le quattro gambe o con la base appoggiata sul pavimento. Evitare di dondolarsi sulle gambe, salirvi in piedi, sedersi sullo schienale, sedersi sui braccioli e utilizzare il prodotto come scaletta. I tavoli vanno utilizzati con le quattro gambe o con la base appoggiata sul pavimento. Evitare di sedersi sui piani o salirvi in piedi. Alla fine del loro utilizzo i prodotti o i loro componenti non vanno dispersi nell'ambiente. Si consiglia di chiamare le aziende preposte allo smaltimento dei rifiuti per il loro trasporto in discarica. Et al. declina ogni responsabilità per danni derivanti da un uso improprio del prodotto.

materiale plastico

PA (Poliammide)

Pulire il prodotto con un panno morbido e umido. Si consiglia l'utilizzo di detergenti neutri, meglio se diluiti in acqua. Non utilizzare detersivi abrasivi o che contengano, anche in minima quantità, alcool, trielina, ammoniaca e solventi in generale.

PE (Polietilene)

Pulire il prodotto con un panno morbido e umido. Si consiglia l'utilizzo di detergenti neutri, meglio se diluiti in acqua. Non utilizzare detersivi abrasivi o che contengano, anche in minima quantità, alcool, trielina, ammoniaca e solventi in generale. Il prodotto può essere lavato con dispositivi a pressione: tenere la punta del diffusore ad una distanza minima di 60cm dalla superficie del manufatto.

PP (Polipropilene)

Pulire il prodotto con un panno morbido e umido. Si consiglia l'utilizzo di detergenti neutri, meglio se diluiti in acqua. Non utilizzare detersivi abrasivi o che contengano, anche in minima quantità, alcool, trielina, ammoniaca e solventi in generale. Le scocche in PP sono trattate anti-UV. Il trattamento anti-UV è soggetto a un'usura che si accelera in caso di esposizione continua e prolungata alle intemperie e a forti sbalzi di temperatura. Per mantenere a lungo il prodotto in buone condizioni consigliamo di conservarli durante l'inverno in luoghi chiusi e asciutti e al riparo da forti sbalzi termici.

PP+PET (Polipropilene + Polietilene tereftalato – Tecnopolimero composito multistrato a densità variabile)

Pulire il prodotto con un panno morbido e umido. Si consiglia l'utilizzo di detergenti neutri, meglio se diluiti in acqua. Non utilizzare detersivi abrasivi o che contengano, anche in minima quantità, alcool, trielina, ammoniaca e solventi in generale. Le scocche in PP+PET sono trattate anti-UV. Il trattamento anti-UV è soggetto a un'usura che si accelera in caso di esposizione continua e prolungata alle intemperie e a forti sbalzi di temperatura. Per mantenere a lungo il prodotto in buone condizioni consigliamo di conservarli durante l'inverno in luoghi chiusi e asciutti e al riparo da forti sbalzi termici.

XLP (Xiloplast)

Lavare il prodotto con acqua e detergente neutro incolore. Sciacquare con acqua a temperatura non superiore ai 30°C. Il prodotto può essere lavato con dispositivi a pressione: tenere la punta del diffusore ad una distanza minima di 60cm dalla superficie del manufatto.

legno

Faggio – Frassino

Pulire il prodotto con un panno morbido e umido. Si consiglia l'utilizzo di detergenti neutri, meglio se diluiti in acqua. In seguito risciacquare con una spugna bagnata e asciugare con un panno asciutto.

Iroko

Trattandosi di materiale naturale, si potrebbero osservare variazioni di colore o anche crepe dovute al grado di umidità e ai bruschi cambiamenti di temperatura. Si consiglia, per conservare il prodotto, di applicare ogni 6 mesi un protettivo a base di olio biologico (es. LAYTECH LAB94149). LAB94149).

rivestimenti

tessuto

Sawana, Citadel, Medley, Go-Couture, Go-Check, Solids & Stripes, Superb Trevira, Rivet, Bubble, Revive 2
Pulire il prodotto con un panno morbido e umido utilizzando detergente neutro.

ecopelle e cuoio

Inca, Crazy, Valencia, Parotega NF, Cuoio
Pulire il prodotto con una spugna inumidita in acqua tiepida e detergente neutro.

lana

Criss Cross, Europost 2, Fame, Main Line Flax, Balta, Remix 2, Steelcut Trio 3
Utilizzare smacchiatori a secco.

metallo

AC VR – AC CR – AC CR S – AC CR X (Acciaio Verniciato – Cromato – Cromato satinato – Cromato brunito – Cromato ottonato)
Pulire il prodotto con un panno morbido e umido utilizzando detergente neutro.

In caso i prodotti vengano usati all'esterno è fortemente consigliato il trattamento di zincatura o di cataforesi. Per mantenere a lungo il prodotto in buone condizioni consigliamo di conservarli durante l'inverno in luoghi chiusi e asciutti in modo da evitare le formazioni di condensa. Prima della stagione invernale e con cadenza trimestrale, se i prodotti sono conservati in prossimità del mare, si raccomanda di pulire le superfici di metallo con un panno morbido utilizzando acqua o detergenti e proteggerle con olio di vaselina.

AX (Acciaio Inox: Satinato – Lucido)
Pulire il prodotto con un panno morbido ed umido utilizzando detergente neutro. Per proteggere il prodotto durante un eventuale stoccaggio si consiglia di stendere un velo di paraffina con l'utilizzo di un panno.

AL COL – AL LUC – AL PSH – AL VR (Alluminio Anodizzato – Anodizzato lucido – Lucidato – Verniciato)
Pulire il prodotto con un panno morbido ed umido utilizzando detergente neutro.

finiture piani tavoli

LAM (Laminato)

La superfioie va pulita con regolarità attraverso un panno umido di acqua calda e detergenti delicati; sono ben tollerati quasi tutti i normali prodotti detergenti o disinfettanti domestici purché non siano abrasivi o alcalini.

WRZ (Werzalit)

La superficie va pulita con regolarità attraverso un panno umido di acqua calda e detergenti delicati; sono ben tollerati quasi tutti i normali prodotti detergenti o disinfettanti domestici purché non siano abrasivi o alcalini.

STR (Stratificato HPL: Full Color – Compact)

La superficie va pulita con regolarità attraverso un panno umido di acqua calda e detergenti delicati; sono ben tollerati quasi tutti i normali prodotti detergenti o disinfettanti domestici purché non siano abrasivi o alcalini.

General instructions for the use of Et al. products

To ensure that Et al. products are long-lasting, we advise periodically checking that the screws are properly tightened and keeping them away from heat sources. The seats should be used with four legs or the base resting on the floor. Avoid rocking on the legs, standing on the chair, sitting on the backrest or the arms or using the product as a stepladder. The tables should be used with four legs or the base resting on the floor. Do not sit or stand on the table top. When no longer required, the products and their components must be disposed of responsibly. We recommend calling a waste disposal company to remove unwanted products and components. Et al. declines any responsibility for damages resulting from improper use of the products..

plastic

PA (Polyamide)

Clean the product with a soft, damp cloth. We recommend using neutral detergents, preferably diluted in water. Do not use abrasive detergents or ones which contain even minimum quantities of alcohol, trichloroethylene, ammonia or solvents, in general.

PE (Polyethylene)

Clean the product with a soft, damp cloth. We recommend using neutral detergents, preferably diluted in water. Do not use abrasive detergents or ones which contain even minimum quantities of alcohol, trichloroethylene, ammonia or solvents, in general. The product can be washed with pressure devices: keep the nozzle at least 60 cm from the product surface.

PP (Polypropylene)

Clean the product with a soft, damp cloth. We recommend using neutral detergents, preferably diluted in water. Do not use abrasive detergents or ones which contain even minimum quantities of alcohol, trichloroethylene, ammonia or solvents, in general. The PP frames are anti-UV treated. The anti-UV treatment is subject to more rapid wear in the event of continual and prolonged exposure to the elements and significant changes in temperature. To maintain the product in good condition for a long time, we recommend storage in closed and dry environments that are sheltered from significant differences in temperature during the winter.

PP+PET (Polypropylene + Polyethylene terephthalate – multi-layer technopolymer composite with variable density)

Clean the product with a soft, damp cloth. We recommend using neutral detergents, preferably diluted in water. Do not use abrasive detergents or ones which contain even minimum quantities of alcohol, trichloroethylene, ammonia or solvents, in general. The PP+PET frames are anti-UV treated. The anti-UV treatment is subject to more rapid wear in the event of continual and prolonged exposure to the elements and significant changes in temperature. To maintain the product in good condition for a long time, we recommend storage in closed and dry environments that are sheltered from significant differences in temperature during the winter.

XLP (Xiloplast)

Wash the product with water and colourless neutral detergent. Rinse with warm water that does not exceed 30°C. The product can be washed with pressure devices: keep the nozzle at least 60 cm from the product surface.

wood

Beech – Ash

Clean the product with a soft, damp cloth. We recommend using neutral detergents, preferably diluted in water. Then, wipe down with a wet sponge and dry with a dry cloth.

Iroko

Since this is a natural material, you may notice colour variations or cracks caused by humidity or sudden changes in temperature. To preserve the product, we recommend applying a protective layer of organic oil every six months (e.g. LAYTECH LAB94149).

covering

fabric

Sawana, Citadel, Medley, Go-Couture, Go-Check, Solids & Stripes, Superb Trevira, Rivet, Bubble, Revive 2
Clean the product with a soft, damp cloth and a mild detergent.

eco-leather or faux leather

Inca, Crazy, Valencia, Parotega NF, Leather
Clean the product with a sponge, warm water and a mild detergent.

wool

Criss Cross, Europost 2, Fame, Main Line Flax, Balta, Remix 2, Steelcut Trio 3
Use a dry stain remover.

metal

AC VR – AC CR – AC CR S – AC CR X (Painted – Chrome-plated – Satin chrome-plated – Burnished chrome – Brass Chrome Steel)
Clean the product with a soft, damp cloth and a neutral detergent.

In the event of product use outdoors, we highly recommend zinc-coating or cataphoresis treatments. To maintain the product in good condition for a long time, we recommend storage in closed and dry environments in order to avoid condensation. If the products are used or stored in seaside environments, before the winter season and every three months, we recommend cleaning the metal surfaces, with a soft cloth using water or detergents, and applying Vaseline oil.

AX (Stainless Steel: Satin-finish – Polished)

Clean the product with a soft, damp cloth, using a neutral detergent. We recommend using a cloth to apply a thin layer of paraffin to protect the product when stored.

AL COL – AL LUC – AL PSH – AL VR (Anodised – Polished anodised – Polished Painted aluminium)
Clean the product with a soft, damp cloth, using a neutral detergent.

table top finishes

LAM (Laminated)

The surface should be cleaned regularly with a warm, damp cloth and mild detergents; Most standard detergents or household disinfectants can be used provided they are not abrasive or alkaline.

WRZ (Werzalit)

The surface should be cleaned regularly with a warm, damp cloth and mild detergents; Most standard detergents or household disinfectants can be used provided they are not abrasive or alkaline.

STR (HPL Solid Laminate: Full color – Compact)
The surface should be cleaned

regularly with a warm, damp cloth and mild detergents. Most standard detergents or household disinfectants can be used provided they are not abrasive or alkaline.

Instructions générales pour l'utilisation des produits Et al.

Afin de garantir une longue durée de vie aux produits Et al., nous conseillons de vérifier régulièrement que les vis sont bien serrées et que les produits sont utilisés loin de sources de chaleur. Les chaises doivent être utilisées avec les quatre pieds ou le socle posé au sol. Éviter de se balancer en soulevant les pieds de la chaise, de se mettre debout sur l'assise, de s'asseoir sur le dossier ou sur les accoudoirs. Les tables doivent être utilisées avec les quatre pieds ou le socle posé au sol. Éviter de s'asseoir ou de se mettre debout sur le plateau. À la fin de leur vie utile, les produits et leurs composants doivent être éliminés dans le respect de l'environnement. Il est conseillé de contacter une entreprise préposée au traitement des déchets pour leur transport en décharge. Et al. décline toute responsabilité pour les dommages résultant d'une mauvaise utilisation du produit.

matière plastique

PA (Polyamide)

Nettoyer le produit avec un chiffon doux et humide. Il est conseillé d'utiliser des détergents neutres, de préférence dilués dans de l'eau. Ne pas utiliser de détergents abrasifs ou qui contiennent de l'alcool, du trichloréthylène, de l'ammoniaque et tout solvant, même en quantité très réduite.

PE (Polyéthylène)

Nettoyer le produit avec un chiffon doux et humide. Il est conseillé d'utiliser des détergents neutres, de préférence dilués dans de l'eau. Ne pas utiliser de détergents abrasifs ou qui contiennent de l'alcool, du trichloréthylène, de l'ammoniaque et tout solvant, même en quantité très réduite. Le produit peut être lavé avec des appareils de nettoyage sous pression : garder la pointe du diffuseur à une distance minimum de 60 cm de la surface du meuble.

PP (Polypropylène)

Nettoyer le produit avec un chiffon doux et humide. Il est conseillé d'utiliser des détergents neutres, de préférence dilués dans de l'eau. Ne pas utiliser de détergents abrasifs ou qui contiennent de l'alcool, du trichloréthylène, de l'ammoniaque et tout solvant, même en quantité très réduite. Les coques en PP sont traitées anti-UV. Le traitement anti-UV est sujet à une usure plus rapide en cas d'exposition continue et prolongée aux intempéries et aux brusques variations de température. Pour garantir durablement le bon état du

produit, en hiver, il est recommandé de le conserver dans un lieu clos, à l'abri de l'humidité et des brusques variations de température.

PP+PET (Polypropylène + Polyéthylène téréphtalate - Technopolymère composite multicouche à densité variable)

Nettoyer le produit avec un chiffon doux et humide. Il est conseillé d'utiliser des détergents neutres, de préférence dilués dans de l'eau. Ne pas utiliser de détergents abrasifs ou qui contiennent de l'alcool, du trichloréthylène, de l'ammoniaque et tout solvant, même en quantité très réduite. Les coques en PP+PET sont traitées anti-UV. Le traitement anti-UV est sujet à une usure plus rapide en cas d'exposition continue et prolongée aux intempéries et aux brusques variations de température. Pour garantir durablement le bon état du produit, en hiver, il est recommandé de le conserver dans un lieu clos, à l'abri de l'humidité et des brusques variations de température.

XLP (Xiloplast)

Laver le meuble avec de l'eau et du détergent neutre incolore. Rincer avec de l'eau à une température ne dépassant pas les 30°C. Le produit peut être lavé avec des dispositifs de nettoyage sous pression : garder la pointe du diffuseur à une distance minimum de 60 cm de la surface du meuble.

bois

Hêtre – Frêne

Nettoyer le produit avec un chiffon doux et humide. Il est conseillé d'utiliser des détergents neutres, de préférence dilués dans de l'eau. Rincer ensuite avec une éponge mouillée et essuyer avec un chiffon sec.

Iroko

S'agissant d'une matière naturelle, il est possible d'observer des variations de couleur ainsi que des fissures dues au degré d'humidité et aux changements brusques de température. Pour mieux conserver le meuble, il est conseillé d'appliquer un produit protecteur à base d'huile biologique (par ex. LAYTECH LAB94149) tous les 6 mois.

revêtements

tissu

Sawana, Citadel, Medley, Go-Couture, Go-Check, Solids & Stripes, Superb Trevira, Rivet, Bubble, Revive 2
Nettoyer le produit avec un chiffon doux et humide en utilisant un détergent neutre.

simili-cuir et cuir

Inca, Crazy, Valencia, Parotega NF, Cuoio
Nettoyer le produit avec une éponge

humidifiée avec de l'eau tiède et un détergent neutre.

Iaines*Criss Cross, Europost 2, Fame, Main Line Flax, Balta, Remix 2, Steelcut Trio 3*
Utiliser un détachant à sec.

métaux

AC VR – AC CR – AC CR S – AC CR X (Acier verni – Chromé – Chromé satiné –Chromé noir – Chromé laiton)

Nettoyer le produit avec un chiffon doux et humide en utilisant un détergent neutre.

Dans le cas où les produits seraient utilisés en extérieur, le traitement de zincage ou de cataphorèse est vivement recommandé. Pour garantir durablement le bon état du produit, en hiver, il est recommandé de le conserver dans un lieu clos et à l'abri de l'humidité pour prévenir la formation de condensation. Avant les mois d'hiver et tous les trois mois si les produits sont utilisés à proximité de la mer, il est recommandé de nettoyer les surfaces métalliques à l'aide d'un chiffon doux, en utilisant de l'eau ou un détergent, et de les protéger à l'aide d'huile de vaseline.

AX (Acier Inox : Satiné – Brillant)

Nettoyer le produit avec un chiffon doux et humide en utilisant un détergent neutre. Pour protéger le produit pendant un éventuel stockage, il est conseillé appliquer une couche de paraffine avec un chiffon.

AL COL – AL LUC – AL PSH – AL VR (Aluminium anodisé – Anodisé brillant – Brillant – Verni)

Nettoyer le produit avec un chiffon doux et humide en utilisant un détergent neutre.

fnitions plateaux des tables

LAM (Stratifié)

Nettoyer régulièrement la surface avec un chiffon humidifié avec de l'eau chaude et des détergents délicats ; pratiquement tous les produits détergents et désinfectants domestiques courants sont bien tolérés à condition qu'ils ne soient pas abrasifs ou alcalins.

WRZ (Werzalit)

Nettoyer régulièrement la surface avec un chiffon humidifié avec de l'eau chaude et des détergents délicats ; pratiquement tous les produits détergents et désinfectants domestiques courants sont bien tolérés à condition qu'ils ne soient pas abrasifs ou alcalins.

STR (Stratifié HPL : Full color – Compact)

Nettoyer régulièrement la surface avec un chiffon humidifié avec de l'eau chaude et des détergents délicats ; pratiquement tous les produits détergents et désinfectants domestiques courants sont bien

tolérés à condition qu'ils ne soient pas abrasifs ou alcalins.

verwendung der produkte von Et al.

Allgemeine hinweise zur verwendung der produkte von Et al.

Um eine lange Haltbarkeit der Produkte von Et al. zu garantieren, empfehlen wir regelmäßig zu überprüfen, ob die Schrauben korrekt eingeschraubt sind und von Wärmequellen fernhalten. Sitzmöbel sind so zu verwenden, dass die vier Beine oder das Gestell auf dem Boden aufliegen. Das Schaukeln auf den Beinen, das Stehen auf den Sitzmöbeln, das Sitzen auf der Rückenlehne oder den Armlehnen und das Verwenden des Artikels als Steighilfe ist zu unterlassen. Die Tische sind so zu verwenden, dass die vier Beine oder das Gestell auf dem Boden aufliegen. Das Sitzen oder Stehen auf der Tischplatte ist zu unterlassen. Am Ende der Lebensdauer dürfen die Produkte oder ihre Bestandteile nicht in der Umwelt entsorgt werden. Kontaktieren Sie ein Entsorgungsunternehmen und organisieren Sie den Transport der Einrichtungsgegenstände zur Abfallsammelstelle. Et al. übernimmt keine Haftung für Schäden, die durch unsachgemäße Verwendung des Produkts entstehen.

Kunststoff

PA (Polyamid)
Das Produkt mit einem weichen und feuchten Tuch reinigen. Die Verwendung neutraler Reinigungsmittel, die mit Wasser verdünnt werden, wird empfohlen. Keine abrasiven Reinigungsmittel oder Reinigungsmittel, die – wenn auch nur in minimalen Mengen - Alkohol, Trichlorethylen, Ammoniak oder Lösungsmittel im Allgemeinen enthalten, verwenden.

PE (Polyäthylen)
Das Produkt mit einem weichen und feuchten Tuch reinigen. Die Verwendung neutraler Reinigungsmittel, die mit Wasser verdünnt werden, wird empfohlen. Keine abrasiven Reinigungsmittel oder Reinigungsmittel, die – wenn auch nur in minimalen Mengen - Alkohol, Trichlorethylen, Ammoniak oder Lösungsmittel im Allgemeinen enthalten, verwenden. Das Produkt kann mit Geräten, die unter Druck stehen, gereinigt werden: Halten Sie die Spitze des Diffusors mindestens 60 cm von der Produktoberfläche entfernt.

PP (Polypropylen)
Das Produkt mit einem weichen und feuchten Tuch reinigen. Die Verwendung neutraler Reinigungsmittel, die mit Wasser verdünnt werden, wird empfohlen. Keine abrasiven Reinigungsmittel oder Reinigungsmittel, die – wenn auch nur in minimalen Mengen - Alkohol, Trichlorethylen, Ammoniak oder Lösungsmittel im Allgemeinen

enthalten, verwenden. Rahmen aus PP mit UV-Schutzbeschichtung Die UV-Schutzbeschichtung nutzt sich im Verlauf der Zeit ab. Diese Abnutzung wird beschleunigt, wenn die Produkte über längere Zeit dauerhaft der Witterung und starken Temperaturschwankungen ausgesetzt sind. Um die Produkte möglichst lange in einwandfreiem Zustand zu erhalten, empfehlen wir, sie während des Winters an einem geschlossenen, trockenen Ort und vor starken Temperaturschwankungen geschützt aufzubewahren.

PP+PET (Polypropylen + Polyethylen – Terephthalat – Mehrschicht-Technopolymer-Verbund mit variabler Dichte)

Das Produkt mit einem weichen und feuchten Tuch reinigen. Die Verwendung neutraler Reinigungsmittel, die mit Wasser verdünnt werden, wird empfohlen. Keine abrasiven Reinigungsmittel oder Reinigungsmittel, die – wenn auch nur in minimalen Mengen - Alkohol, Trichlorethylen, Ammoniak oder Lösungsmittel im Allgemeinen enthalten, verwenden. Rahmen aus PP+PET mit UV-Schutzbeschichtung Die UV-Schutzbeschichtung nutzt sich im Verlauf der Zeit ab. Diese Abnutzung wird beschleunigt, wenn die Produkte über längere Zeit dauerhaft der Witterung und starken Temperaturschwankungen ausgesetzt sind. Um die Produkte möglichst lange in einwandfreiem Zustand zu erhalten, empfehlen wir, sie während des Winters an einem geschlossenen, trockenen Ort und vor starken Temperaturschwankungen geschützt aufzubewahren.

XLP (Xiloplast)
Das Produkt mit Wasser und einem neutralen, farblosen Reinigungsmittel reinigen. Mit Wasser mit einer maximalen Temperatur von 30 °C abspülen. Das Produkt kann mit Geräten, die unter Druck stehen, gereinigt werden: Halten Sie die Spitze des Diffusors mindestens 60 cm von der Produktoberfläche entfernt.

Holz

Buche – Esche
Dazu sollten neutrale, mit Wasser verdünnte Reinigungsmittel verwendet werden. Die Verwendung neutraler Reinigungsmittel, die mit Wasser verdünnt werden, wird empfohlen. Anschließend mit einem nassen Schwamm abwischen und mit einem trockenen Tuch nachtrocknen.

Iroko
Da es sich hierbei um ein natürliches Material handelt, kann es zu Veränderungen in der Farbe oder auch zu Rissen kommen, die auf den Feuchtigkeitsgrad und auf plötzliche Temperaturveränderungen zurückzuführen sind. Um den einwandfreien Zustand des Produkts zu erhalten, sollte alle 6 Monate ein Schutz auf Bioölbasis aufgetragen

werden (z.B. LAYTECH LAB94149).

Bezüge*Sawana, Citadel, Medley, Go-Couture, Go-Check, Solids & Stripes, Superb Trevira, Rivet, Bubble, Revive 2*
Das Produkt mit einem weichen und feuchten Tuch reinigen und dabei ein neutrales Reinigungsmittel verwenden.

Kunstleder und Leder*Inca, Crazy, Valencia, Parotega NF, Cuoio*
Das Produkt mit einem mit lauwarmem Wasser und neutralem Reinigungsmittel getränktem Schwamm reinigen.

Wolle*Criss Cross, Europost 2, Fame, Main Line Flax, Balta, Remix 2, Steelcut Trio 3*
Trockene Fleckentferner verwenden.

Metall

AC VR – AC CR – AC CR S – AC CR X (Stahl: Lackiert – Verchromt – Matt verchromt – Brüniert verchromt – Vermessingt verchromt)
Das Produkt mit einem weichen und feuchten Tuch reinigen und dabei ein neutrales Reinigungsmittel verwenden. Bei Verwendung im Freien wird dringend eine Oberflächenbehandlung wie Verzinkung oder Kataphorese empfohlen. Um die Produkte möglichst lange in einwandfreiem Zustand zu erhalten, empfehlen wir, sie während des Winters an einem geschlossenen, trockenen Ort aufzubewahren, um Kondenswasserbildung zu vermeiden. Bei Einlagerung der Produkte in Küstennähe empfehlen wir, vor dem Winter und alle drei Monate die Metallflächen mit einem weichen Tuch, getränkt mit Wasser oder einem Reinigungsmittel, zu säubern und anschließend mit Vaselineöl zu schützen.

AX (Edelstahl: Matt – Poliert)
Das Produkt mit einem weichen und feuchten Tuch reinigen und dabei ein neutrales Reinigungsmittel verwenden. Um das Produkt während einer eventuellen Lagerung zu schützen, sollte mit einem Tuch eine Paraffinschicht aufgetragen werden.

AL COL – AL LUC – AL PSH – AL VR (Aluminium eloxiert – eloxiert und glänzend – poliert – lackiert)
Das Produkt mit einem weichen und feuchten Tuch reinigen und dabei ein neutrales Reinigungsmittel verwenden.

Oberflächen von Tischplatten*LAM (Laminat)*
Die Oberfläche regelmäßig mit einem mit warmem Wasser und mildem Reinigungsmittel getränkten Tuch säubern; hierzu eignen sich die meisten der haushaltsüblichen

Reinigungs- und Desinfektionsmittel, sofern sie weder abrasiv noch alkalisch sind.

WRZ (Werzalit)
Die Oberfläche regelmäßig mit einem mit warmem Wasser und mildem Reinigungsmittel getränkten Tuch säubern; hierzu eignen sich die meisten der haushaltsüblichen Reinigungs- und Desinfektionsmittel, sofern sie weder abrasiv noch alkalisch sind.

STR (HPL Compact Platte: Full color – Compact)
Die Oberfläche regelmäßig mit einem mit warmem Wasser und mildem Reinigungsmittel getränkten Tuch säubern; hierzu eignen sich die meisten der haushaltsüblichen Reinigungs- und Desinfektionsmittel, sofern sie weder abrasiv noch alkalisch sind.

Instrucciones generales para el uso de los productos Et al.

Para garantizar la duración en el tiempo de los productos Et al., recomendamos controlar periódicamente el ajuste correcto de los tornillos y mantenerlos alejados de fuentes de calor. Los asientos deben utilizarse con las cuatro patas o la base apoyada en el suelo. Evitar balancearse con las patas, ponerse de pie sobre ellos, sentarse en el respaldo, sentarse en los apoyabrazos y utilizar el producto como escalera. Las mesas se deben utilizar con las cuatro patas o con la base apoyada en el suelo. Evitar sentarse en los sobres o ponerse de pie sobre ellos. Al final de su uso, los productos y sus componentes no se deben dispersar en el medio ambiente. Se recomienda comunicarse con las empresas encargadas de la eliminación de los residuos para su transporte al vertedero. Et al. declina cualquier responsabilidad por los daños que puedan resultar del uso inadecuado del producto.

material plástico

PA (Poliamida)
Limpiar el producto con un paño suave y húmedo. Se recomienda el uso de detergentes neutros, preferiblemente diluidos en agua. No utilizar detergentes abrasivos o que contengan, aunque sea en una cantidad mínima, alcohol, tricloroetileno, amoniaco y disolventes en general.

PE (Polietileno)
Limpiar el producto con un paño suave y húmedo. Se recomienda el uso de detergentes neutros, preferiblemente diluidos en agua. No utilizar detergentes abrasivos o que contengan, aunque sea en una cantidad mínima, alcohol, tricloroetileno, amoniaco y disolventes en general. El producto se puede lavar con dispositivos a presión: mantener la punta del difusor a una distancia mínima de 60 cm de la superficie del producto.

PP (Polipropileno)
Limpiar el producto con un paño suave y húmedo. Se recomienda el uso de detergentes neutros, preferiblemente diluidos en agua. No utilizar detergentes abrasivos o que contengan, aunque sea en una cantidad mínima, alcohol, tricloroetileno, amoniaco y disolventes en general. Las carcasas en PP están tratadas anti-UV. El tratamiento anti-UV está sujeto a un desgaste que se acelera en caso de exposición continua y prolongada al mal tiempo y a cambios fuertes de temperatura. Para mantener el producto en buenas condiciones por mucho tiempo, le recomendamos que se mantengan en lugares cerrados y secos durante el invierno y alejado de los cambios fuertes de temperatura.

Para mantener el producto en buenas condiciones por mucho tiempo, le recomendamos que se mantengan en lugares cerrados y secos durante el invierno y alejado de los cambios fuertes de temperatura. Para mantener el producto en buenas condiciones por mucho tiempo, le recomendamos que se mantengan en lugares cerrados y secos durante el invierno y alejado de los cambios fuertes de temperatura.

PP+PET (Polipropileno + Polietileno tereftalato - Tecnopolimero compuesto multicapa de densidad variable)

Limpiar el producto con un paño suave y húmedo. Se recomienda el uso de detergentes neutros, preferiblemente diluidos en agua. No utilizar detergentes abrasivos o que contengan, aunque sea en una cantidad mínima, al, alcohol, tricloroetileno, amoniaco y disolventes en general. Las carcasas en PP + PET están tratadas anti-UV. El tratamiento anti-UV está sujeto a un desgaste que se acelera en caso de exposición continua y prolongada al mal tiempo y a cambios fuertes de temperatura. Para mantener el producto en buenas condiciones por mucho tiempo, le recomendamos que se mantengan en lugares cerrados y secos durante el invierno y alejado de los cambios fuertes de temperatura.

XLP (Xiloplast)
Lavar el producto con agua y detergente neutro incoloro. Enjuagar con agua a temperatura no superior de 30 °C. El producto se puede lavar con dispositivos a presión: mantener la punta del difusor a una distancia mínima de 60 cm de la superficie del producto.

madera

Haya – Fresno
Limpiar el producto con un paño suave y húmedo. Se recomienda el uso de detergentes neutros, preferiblemente diluidos en agua. Después enjuagar con una esponja mojada y secar con un paño seco.

Iroko
Al tratarse de un material natural, podrían presentarse variaciones de color o grietas debidas al grado de humedad y a los bruscos cambios de temperatura. Para conservar el producto, se recomienda aplicar cada 6 meses un protector a base de aceite biológico (p. ej. LAYTECH LAB94149).

revestimientos

tejido*Sawana, Citadel, Medley, Go-Couture, Go-Check, Solids & Stripes, Superb Trevira, Rivet, Bubble, Revive 2*

Limpiar el producto con un paño suave y húmedo usando detergente neutro.

cuero ecológico y cuero*Inca, Crazy, Valencia, Parotega NF, Cuero*
Limpiar el producto con una esponja embebida en agua tibia y detergente neutro.

Ianas*Criss Cross, Europost 2, Fame, Main Line Flax, Balta, Remix 2, Steelcut Trio 3*
Utilizar quitamanchas en seco.

Metal

AC VR – AC CR – AC CR S – AC CR X (Acero Barnizado – Cromado – Cromado satinado – Cromado bruno – Latón cromado)

Limpiar el producto con un paño suave y húmedo usando detergente neutro.

Si los productos se utilizan en el exterior, es muy recomendable el tratamiento de galvanización o cataforesis. Para mantener el producto en buenas condiciones por mucho tiempo, recomendamos mantenerlo en lugares cerrados y secos durante el invierno para evitar la condensación. Antes de la temporada del invierno y trimestralmente, si los productos están cerca del mar, se recomienda limpiar las superficies en metal con un paño suave con agua o detergentes y protegerlos con aceite de vaselina.

AX (Acero inoxidable: satinado – pulido)

Limpiar el producto con un paño suave y húmedo usando detergente neutro. Para proteger el producto durante el almacenamiento se recomienda aplicar una fina capa de parafina utilizando un paño.

AL COL – AL LUC – AL PSH – AL VR (Aluminio anodizado – anodizado pulido – pulido – barnizado)

Limpiar el producto con un paño suave y húmedo usando detergente neutro.

acabados de sobres de mesa

LAM (Laminado)
La superficie se debe limpiar regularmente con un paño humedecido en agua caliente y detergente suave; se toleran bien casi todos los detergentes o desinfectantes domésticos habituales, siempre que no sean abrasivos o alcalinos.

WRZ (Werzalit)
La superficie se debe limpiar regularmente con un paño humedecido en agua caliente y detergente suave; se toleran

bien casi todos los detergentes o desinfectantes domésticos habituales, siempre que no sean abrasivos o alcalinos.

STR (Estratificado HPL: Full color – Compact)
La superficie se debe limpiar regularmente con un paño humedecido en agua caliente y detergente suave; se toleran bien casi todos los detergentes o desinfectantes domésticos habituales, siempre que no sean abrasivos o alcalinos.

Art direction
and graphic design

Leonardo Sonnoli
Irene Bacchi
– Studio Sonnoli –

Foto / Photo

Amati-Bacciardi
Massimo Gardone
Alberto Chiariglione
Guðmann Þór Bjargmundsson
Matroskin Photography
Kris Thijs
Sergey Zhabskiy

Crediti / Credits

Antonio Bachour
Arch. Aloi Natale Fabio
Atalaya Jávea
Fondazione Piccolo Teatro
di Milano - Teatro d'Europa
Harpa Lind
ifi contract
JK Lab Architects
Marazzi Ceramiche,
Stand Cersaie 2018, Ph. Op-Fot.
motif design
Norén Concept
Serist srl
S.I.D. interior
velvetLAB
Wisp Architects

Carattere / Font

Founders Grotesk

Carta / Paper

Sappi Magno Matt 150 gr

Prestampa / Pre-press

Olimpia Visual plan

Stampa/Printing

Grafiche Antiga



Tutte le dimensioni, pesi, caratteristiche
e colori dei prodotti pubblicati sono
puramente indicativi. / All dimensions,
weights, characteristics and colours of the
products listed are purely indicative.

I colori reali possono variare rispetto ai
riferimenti cromatici forniti a causa delle
inevitabili differenze tra i materiali utilizzati
e la riproduzione tipografica. Si prega di
contattare l'ufficio commerciale prima
dell'ordine per informazioni aggiornate. /
Actual colours can be different than those
indicated in the finishes section due to the
inevitable differences between the material
used and the typographical reproduction.
You are kindly invited to contact the sales
department for further information before
placing your order.

Et al. si riserva il diritto di apportare
modifiche e/o migliorie di carattere tecnico
ed estetico ai propri prodotti in qualsiasi
momento e senza obbligo di preavviso. /
Et al. reserves the right to make
modifications and/or improvements of
technical and aesthetical nature to its
products at any time and without prior
notice.

Per certificazioni prodotti vedi /
For products certifications see

www.et-al.it

Et al.
è una divisione di
is a division of



IFI S.p.A.
Strada Selva Grossa, 28/30
61010 Tavullia (PU) – Italy

©Copyright IFI S.p.A.
Tavullia (PU) - Italia, 09/2019

Tutti i diritti riservati
All rights reserved

I prodotti possono essere
tutelati da brevetto e/o da design
Products may be protected
by patent and/or design



Et al.
Strada Selva Grossa, 28/30
61010 Tavullia (PU) - Italy
www.et-al.it

Italia
T +39 0721 203607
commerciale@et-al.it

Export
T +39 0721 203601
export@et-al.it

follow us



